

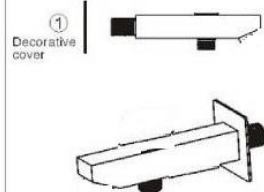

◆ Water spout installation



① Decorative cover

- ③ — Cup
- ④ — Screw
- ⑤ — Shunt switch
- ⑥ — Rubber washer

Install the decorative cover under the water spout, and then tighten it into the wall using the waterproof tape.

◆ Body jet installation

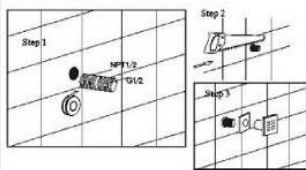

Step 1 Wrap the threaded pipe of NPT1/2 with Teflon tape and screw it into the wall.  
Step 2 Cut off excess part with a saw.  
Step 3 Put on the decoration cap, then screw the massage shower in.

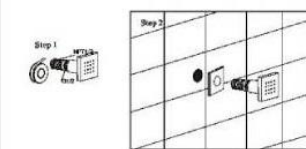

◆ Install the hand shower holder

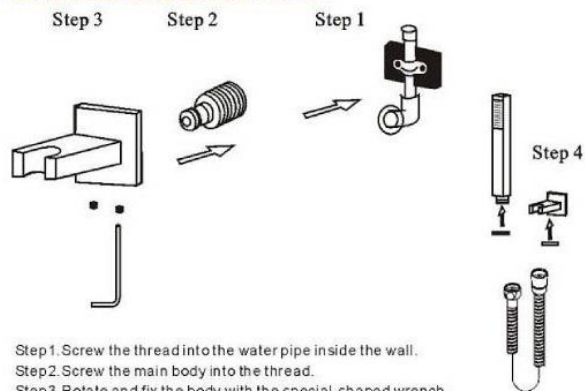

Step 1. Screw the thread into the water pipe inside the wall.  
Step 2. Screw the main body into the thread.  
Step 3. Rotate and fix the body with the special-shaped wrench.  
Step 4. Connect hand shower and the hose.

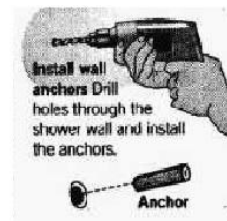
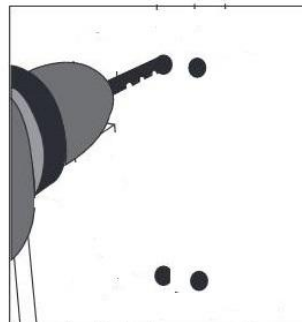

**Install wall anchors** Drill holes through the shower wall and install the anchors.

Anchor

vertical distance for two silver brackets should be between 23.5~24.5 inch and drill two holes in vertical



attach silver brackets to the tile wall and tighten up them

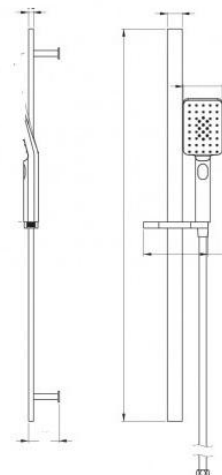

attach sliding bar to the two silver brackets and tighten the side screws on sliding bar

## Parts list

No.	Name	QTY
1	Expansion screws	4
2	Inwall box	1
3	Water inlet	3
4	S8 Allen Key	1
5	Flange	1
6	Allen Key 2.5	1
7	M4 screw	2
8	Shower head body	1
9	Installation Instruction	1

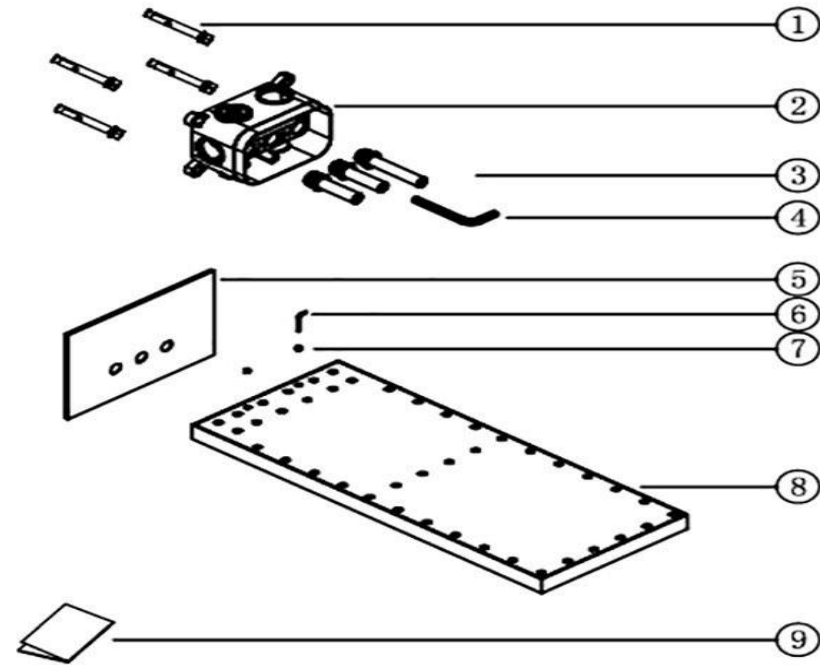

1. Digging wall according to following size, and connect rain and rainfall inlet correctly.

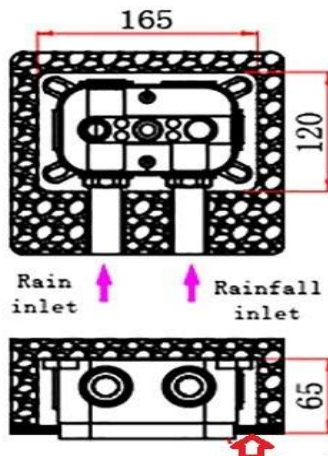

65mm=2 1/2 inch  
unit: mm

2. Lock Inwall box by four expansion screws while gurantee horizontal level. Do not remove the cover inside inwall box when seal wall by cement to prevent cement stick to screws of brass body.

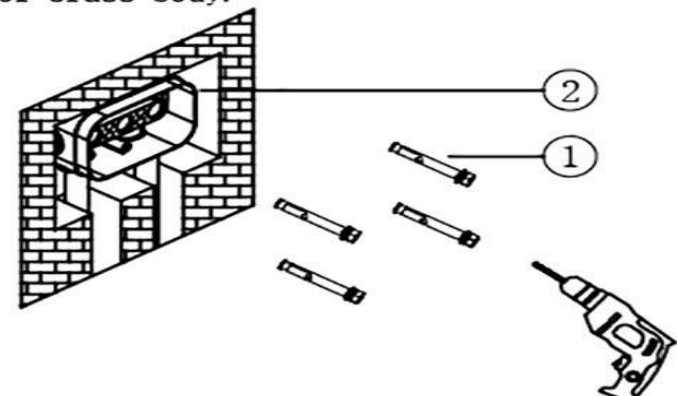

3. Remain inwall box in same level as wall after seal the tile.

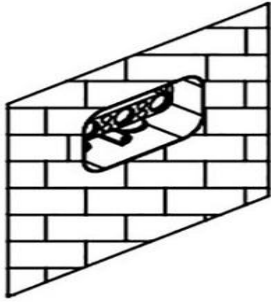

4. Install shower head body. First, remove the cover inside inwall box, screw three water inlets into inwall box with S8 Allen Key.

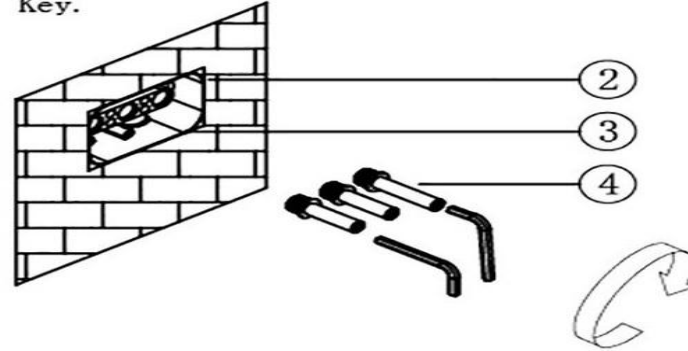

5. Install flange as picture.

**Caution: do setp 4-5-6 to test horizontal and vertical position of shower head before wall seal to avoid any trouble of repair after wall seal.**

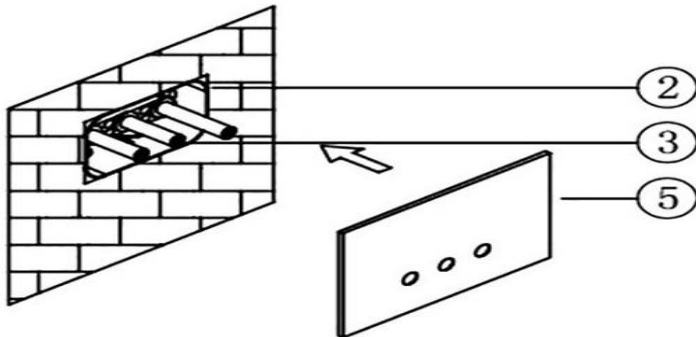

6. Push shower head body into according water inlets, and tighten shower body by M4 screw with Allen Key 2.5.

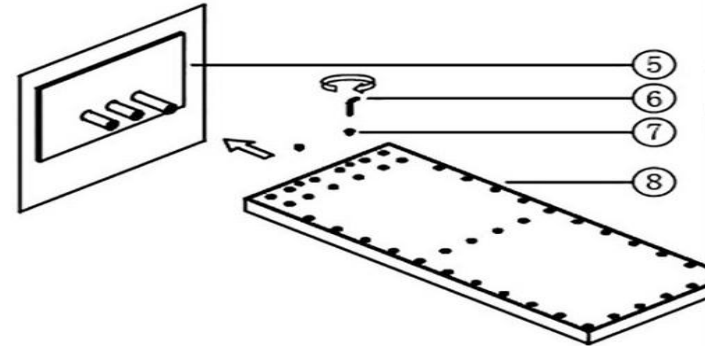

### Installation Finish.

Attention: no need to remove screws on backcover of shower head body when installation.

