

Assembly Instructions

Caution : You must read this before you proceed

Barstool

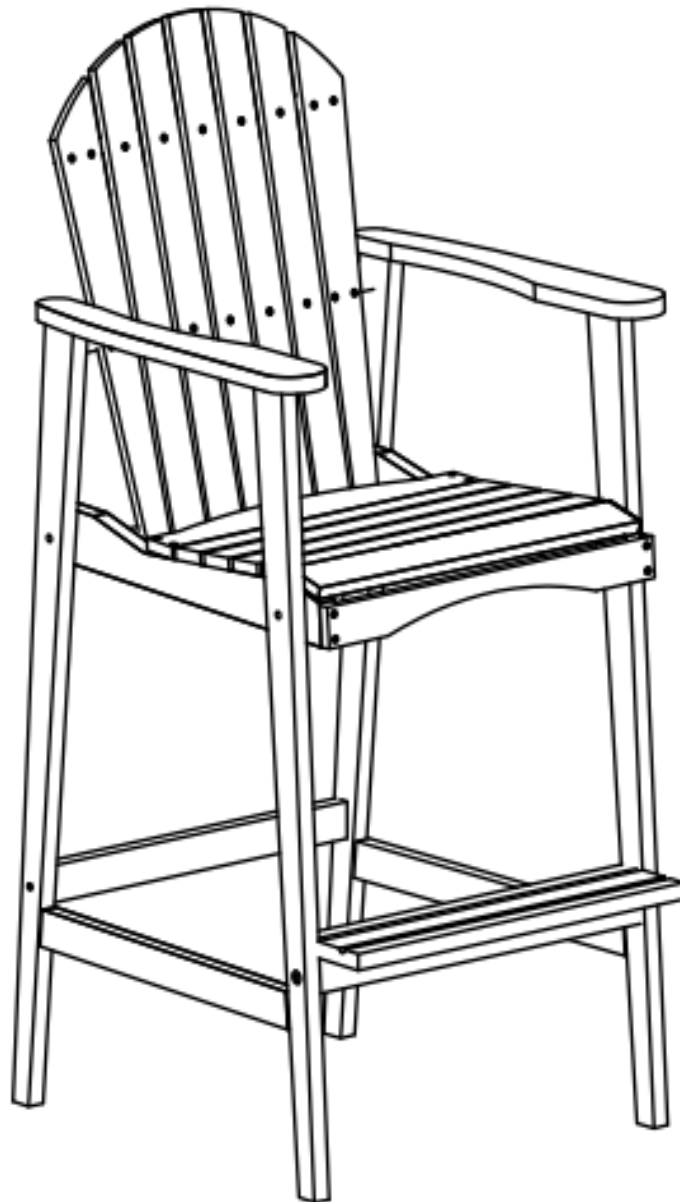



CAUTION : This Barstool is NOT a TOY.

Keep your child / children at bay during the assembly process.

For moving the Barstool and to prevent damage to the Barstool, two adults are needed to execute this action.

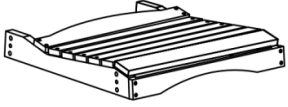
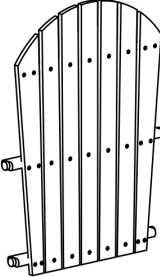
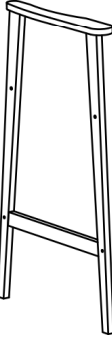
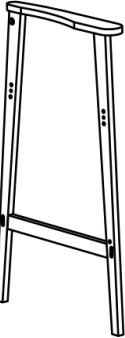
Parts List

Label	Picture	Description	QTY
A		Seat Panel	1
B		Backrest Panel	1
C		Left Leg Panel	1
D		Right Leg Panel	1
E		Footrest	1
F		Leg Support Bar	1





Hardware

Label	Picture	Description	QTY
①		Screw (M7x50mm)	9
②		Bolt (M8 x 30mm)	5
③		Sleeve Nut (M8x15mm)	5
④		Wooden Dowel (φ10x25mm)	11
⑤		Allen key	2

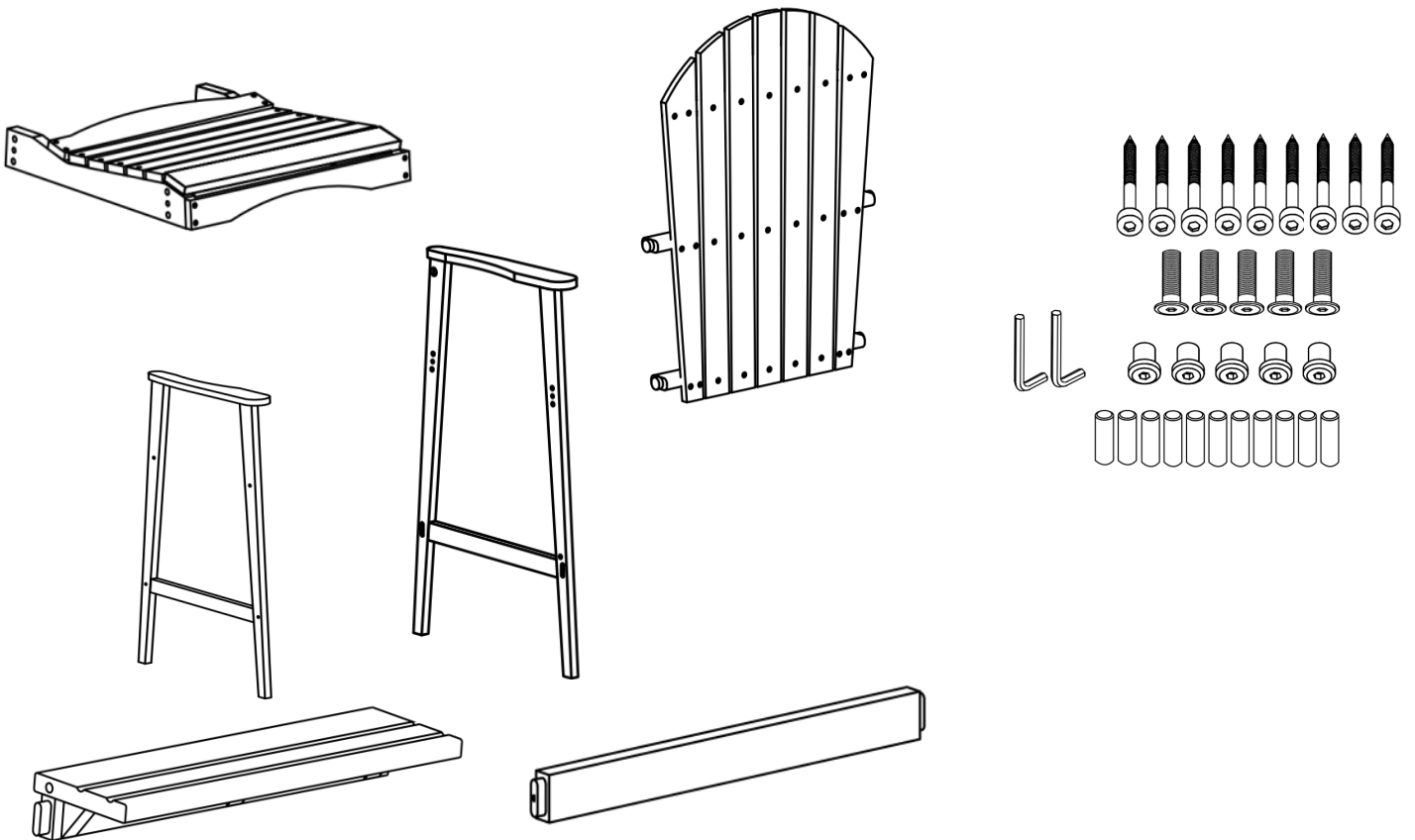
Assembly Preparation

Before Beginning Assembly:



-  • Read instructions, cover to cover-
-  • Have 2 adults on hand for assembly-
-  • Do not assemble on flooring or carpet-
-  • Assemble on a clean non-marring surface (packing foam)-
-  • Save all packaging until finished-

Assembly Steps

OVERVIEW

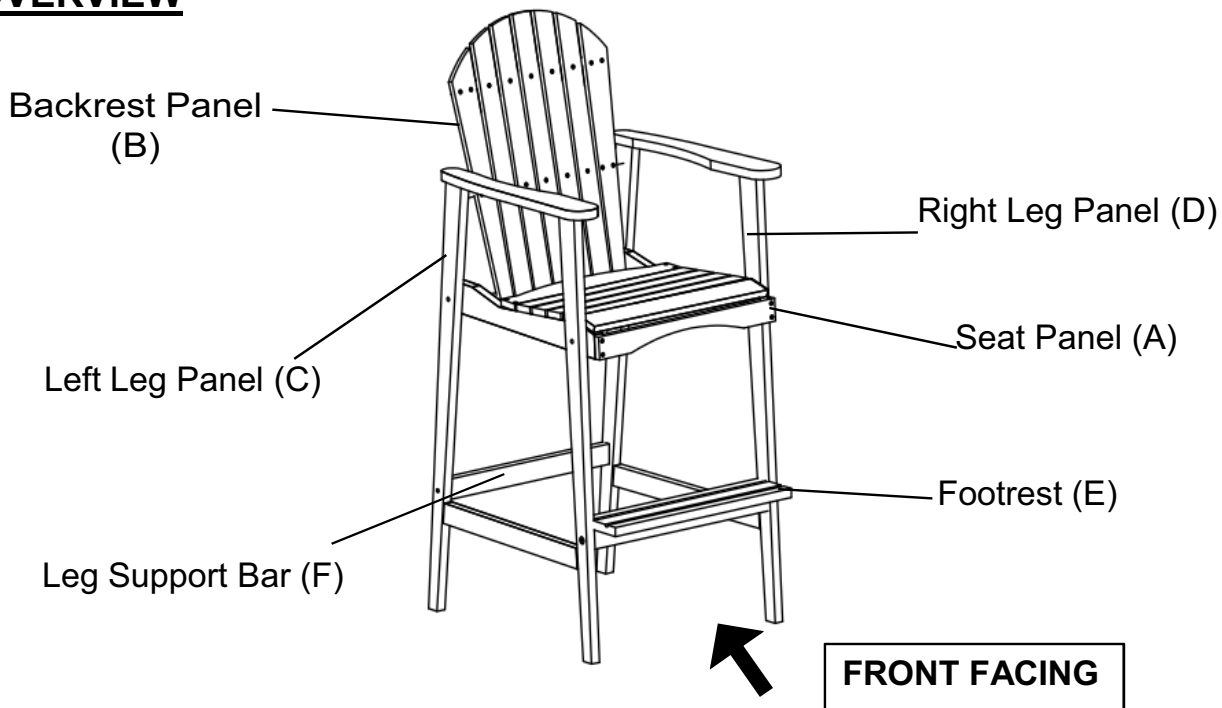

This Barstool has multiple parts and may require up to 30 minutes to assemble. To give you an overview of the Barstool parts, the above picture is to help you put the various parts into perspective. Please read through the instructions below to familiarise yourself with the parts and steps before assembly.

Step 1

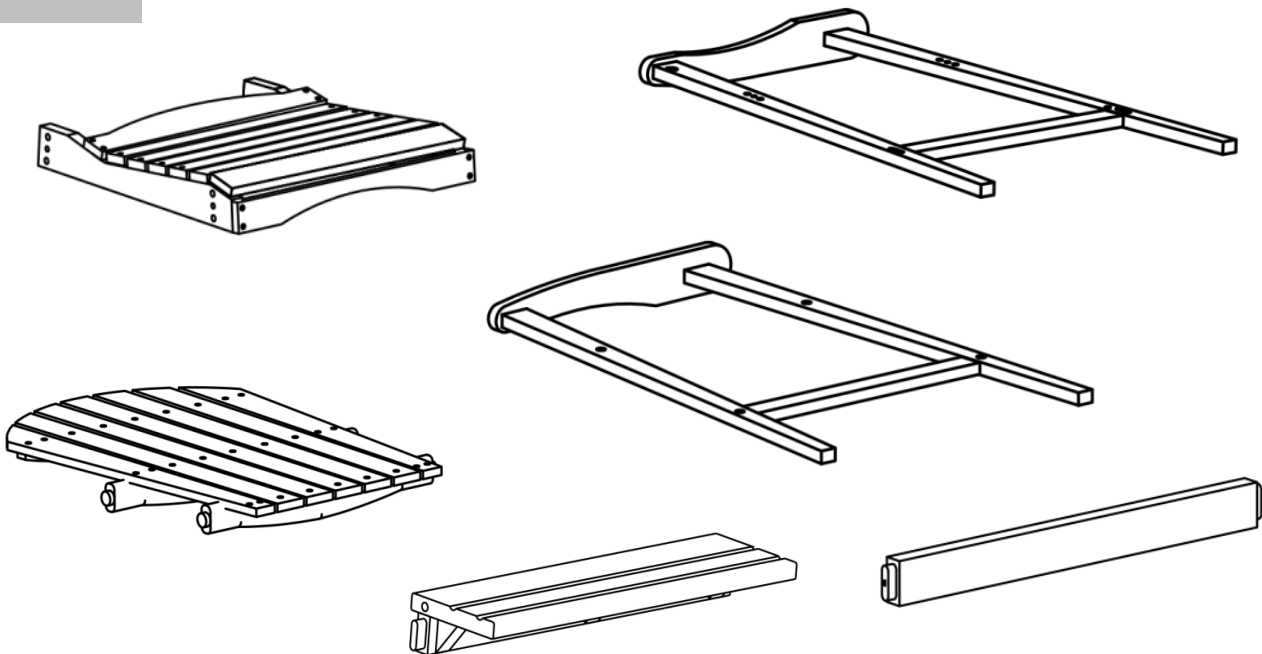

Unpack and place all parts on a clean, non-marring surface.

Step 2

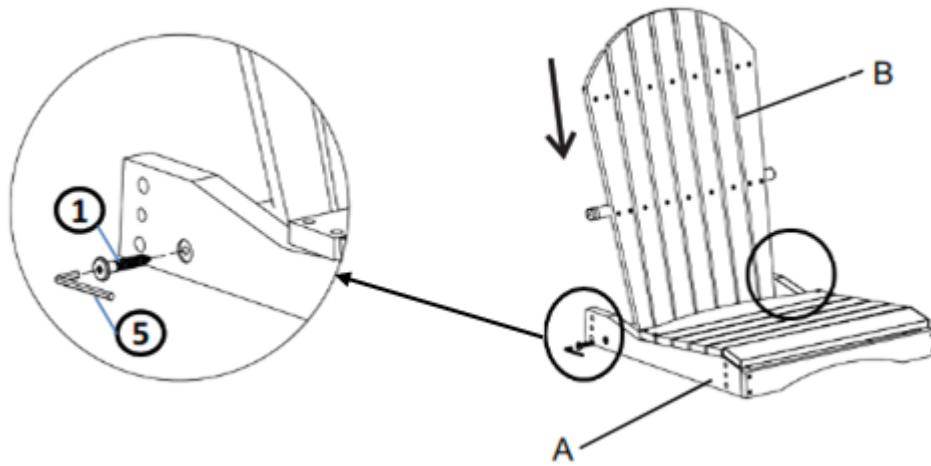

Attach Backrest Panel (B) to the Seat Panel (A) as arrow in pictured above. Secure Backrest Panel (B) to the Seat Panel (A) by using Screw (①) and Allen Key (⑤) at two sides.

Note: Place Backrest Panel (B) from inside of Seat Panel (A) then adjust to fix the housing.

Do not fully tighten the Screws.

Step 3

3.2

3.1

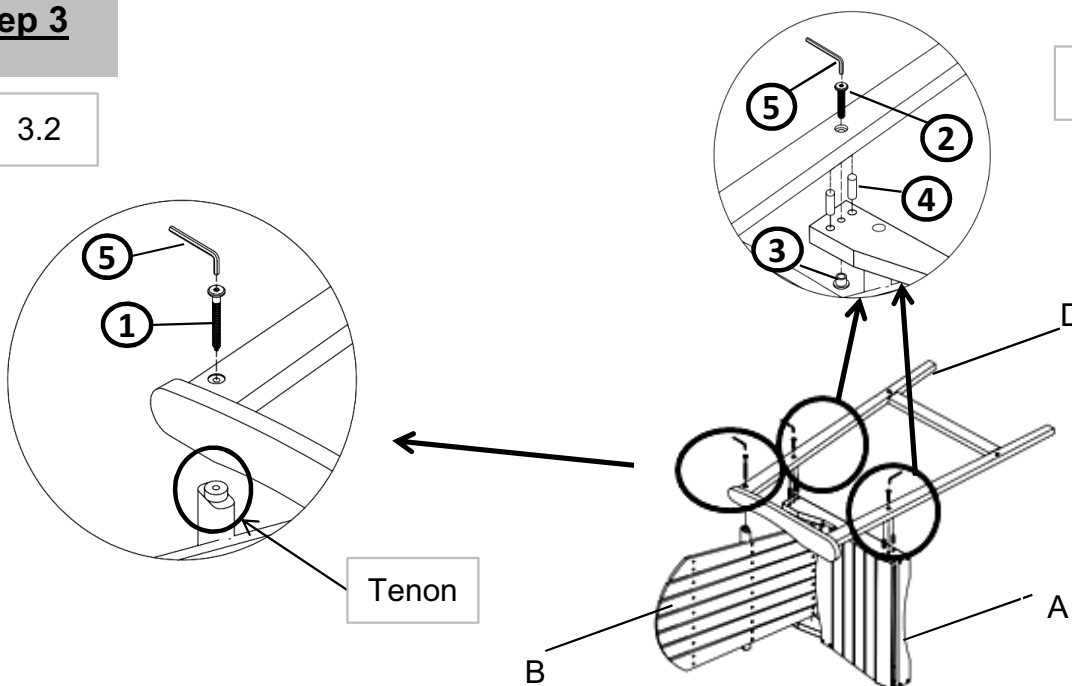

With assistance from your adult partners, turn pre-assemble part in Step 2 to lay on its side.

3.1) By hand, attach Wooden Dowel (④) to Seat Panel (A).

Then, position housing of Right Leg Panel (D) to the Wooden Dowel (④) of Seat Panel (A) and Tenon of Backrest Panel (B) as pictured above.

Secure Right Leg Panel (D) to Seat Panel (A) by using Bolt (②), Sleeve Nut (③) and Allen Key (⑤).

Note: Bolt is in the middle of 2 Wooden Dowels (④).

3.2) Secure Right Leg Panel (D) to Backrest Panel (B) by using Screw (①) and Allen Key (⑤).

Do not fully tighten the Screws.

Step 4

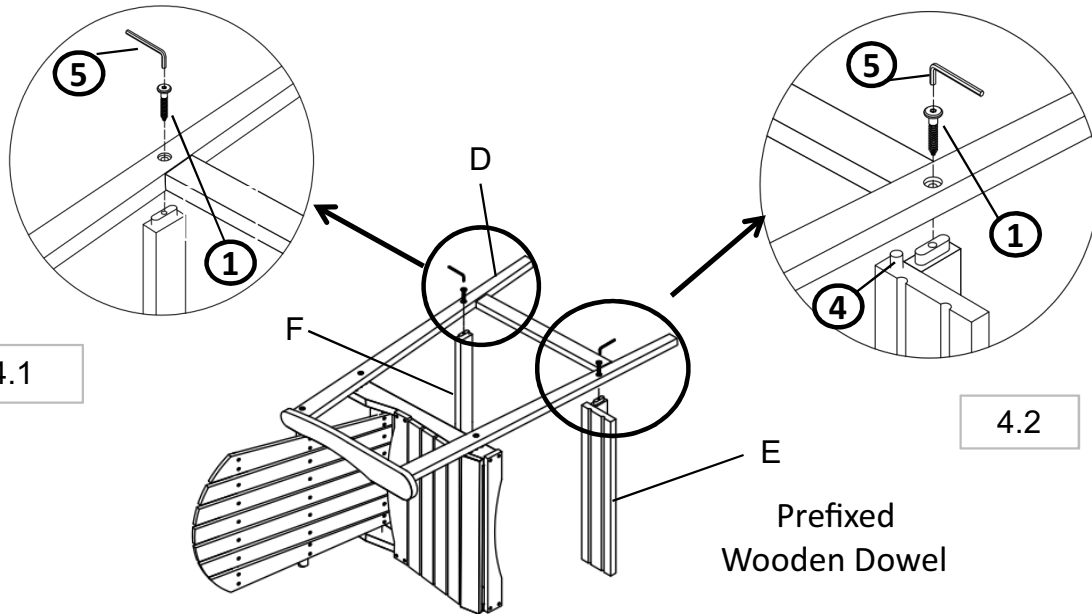

4.1) Attach Leg Support Bar (F) to the Right Leg Panel (D) by using Screw (①) and Allen Key(⑤).

4.2) Attach Wooden Dowel(④) of Footrest (E) to the Right Leg Panel (D) as pictured above and secure by using Screw (①) and Allen Key(⑤).

Do not fully tighten the Screws.

Step 5

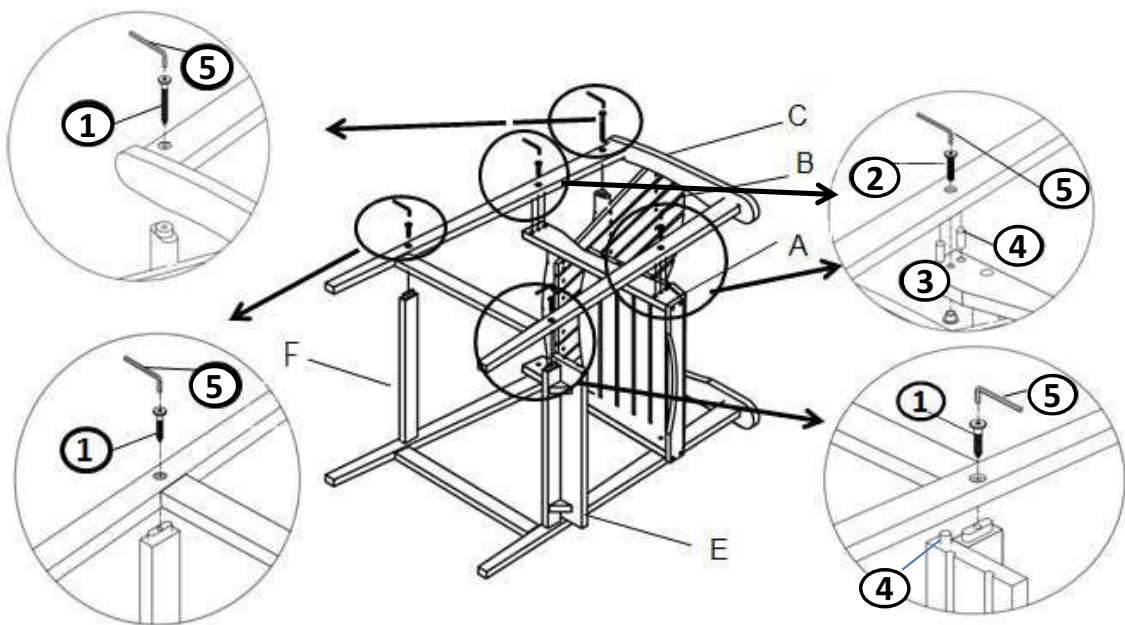

With assistance from your adult partners, turn pre-assemble part in Step 4 to another side.

Repeat the same process of step 3,4 to attach Left Leg Panel (C) to the Seat Panel (A), Backrest Panel (B), Footrest (E) and Leg Support Bar (F).

Do not fully tighten the Screws.

Step 6

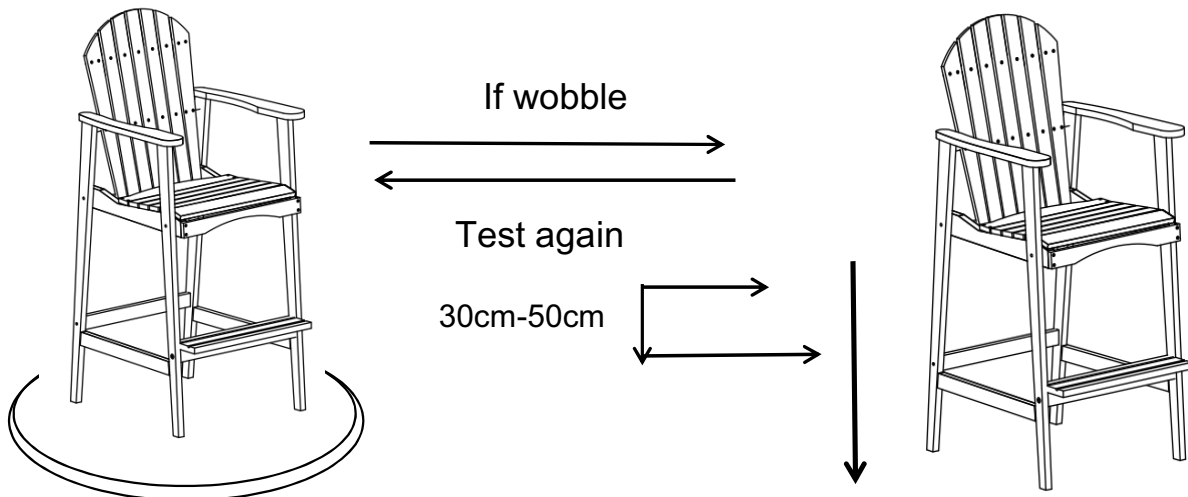

Place the Barstool right side up on a LEVEL SURFACE to see if it wobbles. If it wobbles, lift the Barstool some 30cm to 50cm height from the ground. Keep your feet and toes well away from the drop zone.

Drop the Barstool freely and vertically with all four legs, hitting the ground at the same time.

This Drop Test will help to ensure that all the Bolts, Screws and gaps reach full alignment status.

Test again for evenness on a LEVEL SURFACE.

If no wobbles are found, proceed to tighten all the Screws, and Bolts.

When tightening these screws, tighten sequentially.

Do not tighten any Bolt, or Screw fully and then move towards the next one.

This could cause the frame to warp.

If there are still wobbles, loosen the Screws and Bolts and execute the same drop tests.

If the Barstool is not stable it could lead to damage to the product.

Step 7

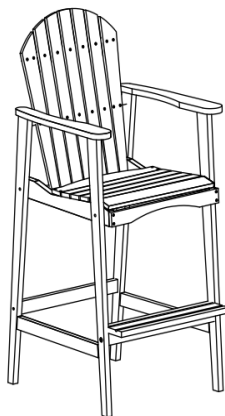



















Inspect the Barstool and make sure all parts are connected.

Your Barstool is ready for use.

This Barstool can only be used on a flat, level surface.

Care & Maintenance

-   ● Do not put hot items directly on furniture surface
 -   ● Do not clean furniture with harsh cleansers or polish.
 -   ● To obtain the longest lifespan of your outdoor products, minimizing exposure to direct sunlight is recommended.
 -   ● Children should not climb or jump on the furniture.
 -   ● Do not write on furniture without a padded barrier to protect the surface.
 -   ● To obtain the longest lifespan of your outdoor products, avoid extended and lengthy exposure to rain, snow, and direct sunshine. Whenever possible cover the product and /or place under patio or awnings.
 -   ● Not for commercial use. For residential use only .
 -   ● Stains may be removed with mild soap solution and damp cloth.
-
-   ● Dust and pick-up spills using a clean, non-colored, lint-free cloth .