

INSTRUCTION MANUAL

11 Ft x 11 Ft Pop Up Canopy With Netting

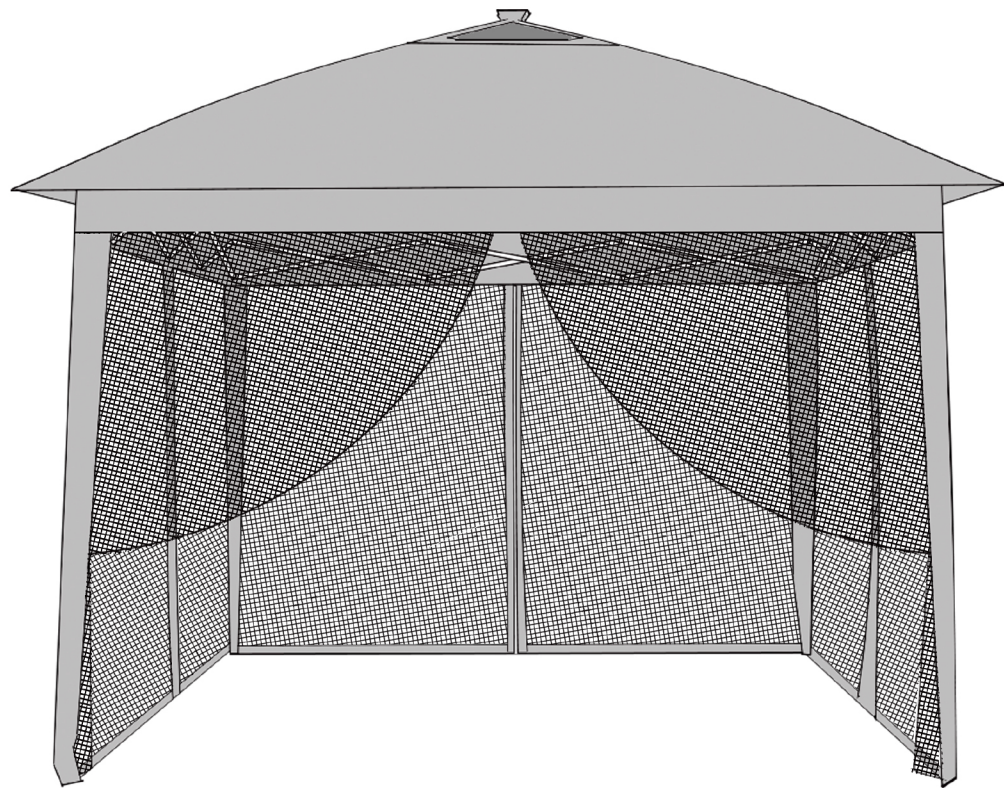

If you have any problem, please do not hesitate to contact us

Thank for choosing our tent!

Thank you very much for buying our products. Before signing for delivery Please check the tent, if it is damaged, please do not hesitate to contact us and take pictures of the damaged parts to send us by email before returning the product to our shop, We will give you the best solution.

It is your responsibility to read and save these instructions before attempting to set up your commercial canopy. We would also like to suggest that you follow these safety precautions, care and maintenance tips when using your canopy.

1. Never set up or continue to use in any rain, wind or storm conditions, especially lightning storms. Damage can occur to your canopy and put you and others in potential danger. Please do not leave your sun shelter up during these conditions.
2. We suggest that you take your time in order to avoid bending the frame or pinching your fingers or hands while opening and closing the frame.
3. Avoid setting up your canopy on steep inclines.
4. Keep your canopy away from heat and flames at all times. Do not barbecue or build fires under your canopy.
5. Never leave your canopy unattended.
6. Hand wash the canopy using only mild soap and water. Never use harsh detergents, abrasives or bleach. Do not machine wash fabric components.
7. Never fold or store your canopy when it is wet or damp. Let it dry completely to avoid mildew.
8. The frame **MUST** be staked or properly weighted down at all times.
9. Keep all flame and heat sources away from this sun shelter fabric.

Important Note:

1. If the light does not work, it is most likely that the battery is very low. Please leave it in the sun for 4 hours or charge it with USB
2. If The remote control doesn't work, maybe the battery is dead, please change the battery in time

PACKING INCLUDES

Part List

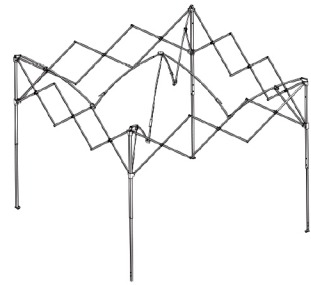

A - Canopy Frame (1pc)

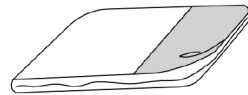

B - Big Top (1pc)

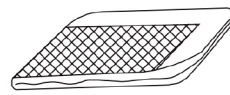

C - Mosquito Netting (1pc)

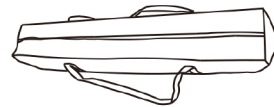

D - Carry Bag (1pc)

Hardware



AA - Stake (4pcs)



BB - Rope (4pcs)



CC - big stake (4pcs)

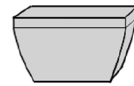

DD - Solar receiver (1pc)

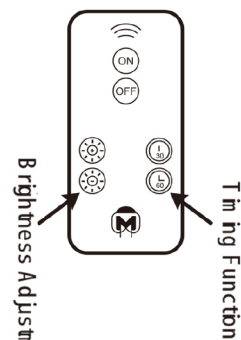
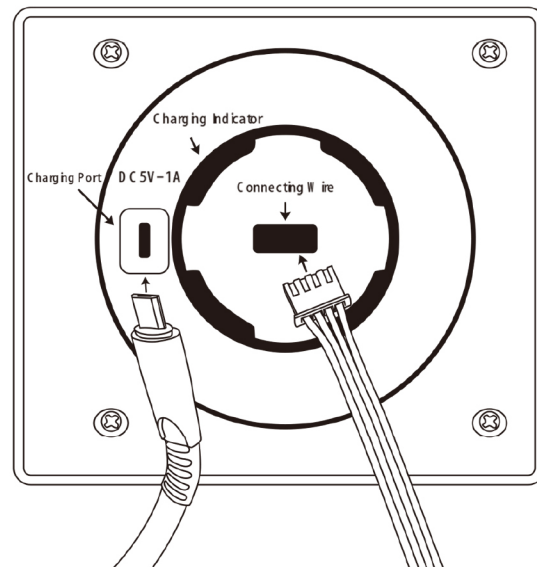

Solar Energy, Remote Control Inside
Please charge with USB before use. When The green light is on, it is fully charged

ATTACH THE BIG TOP

Step 1

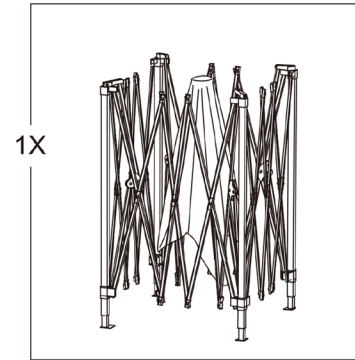

Insert the wire into the solar panel, then align it and rotate it gently.

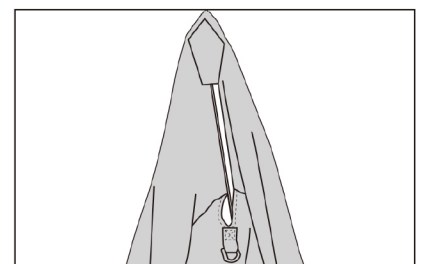
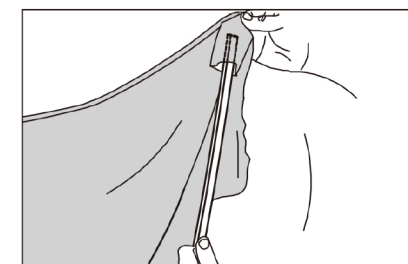
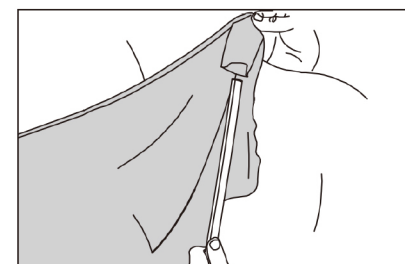
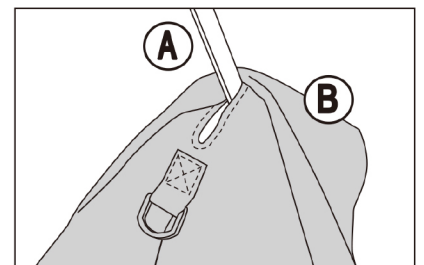
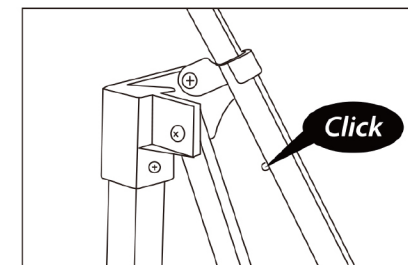
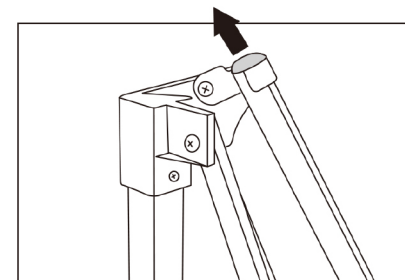
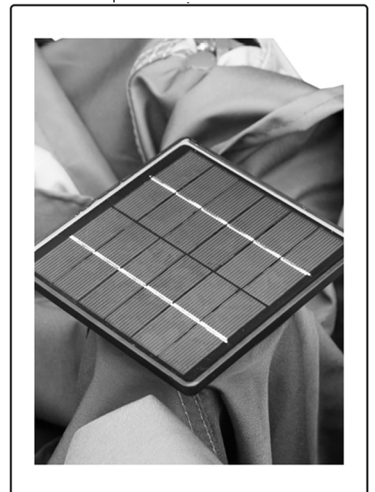
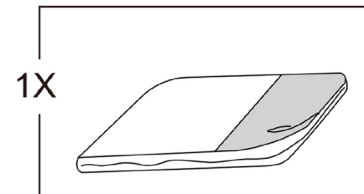
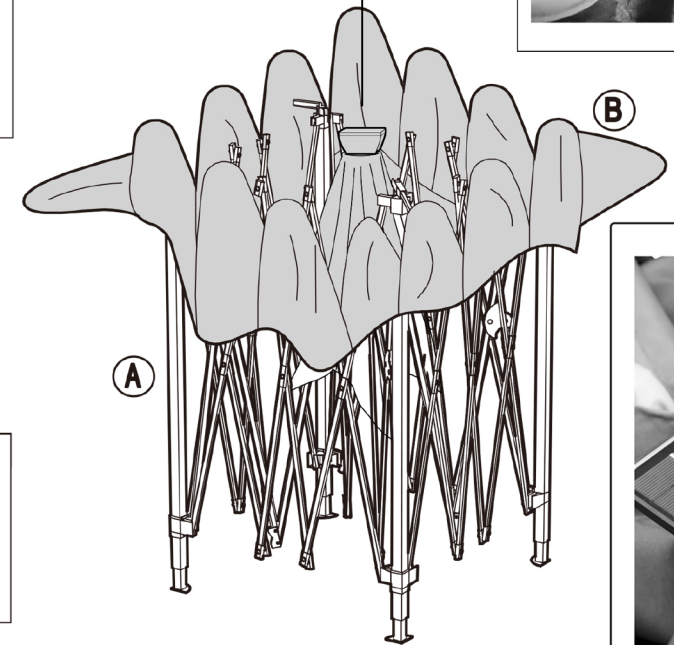

ATTACH THE SMALL TOP & UNFOLD THE CANOPY

Step 2

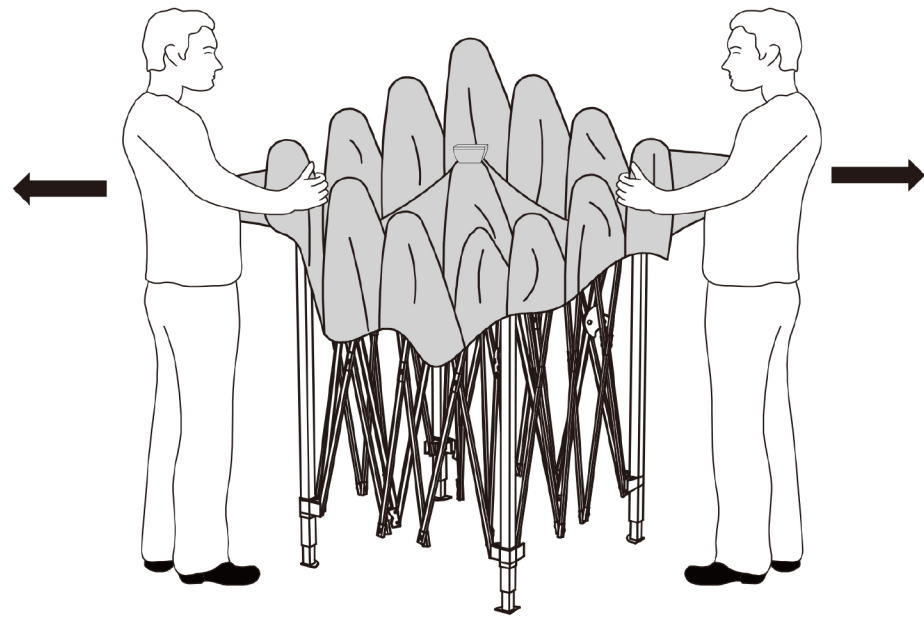

LOCK THE FRAME BEFORE ADJUSTING THE HEIGHT OF THE CANOPY

Step 3

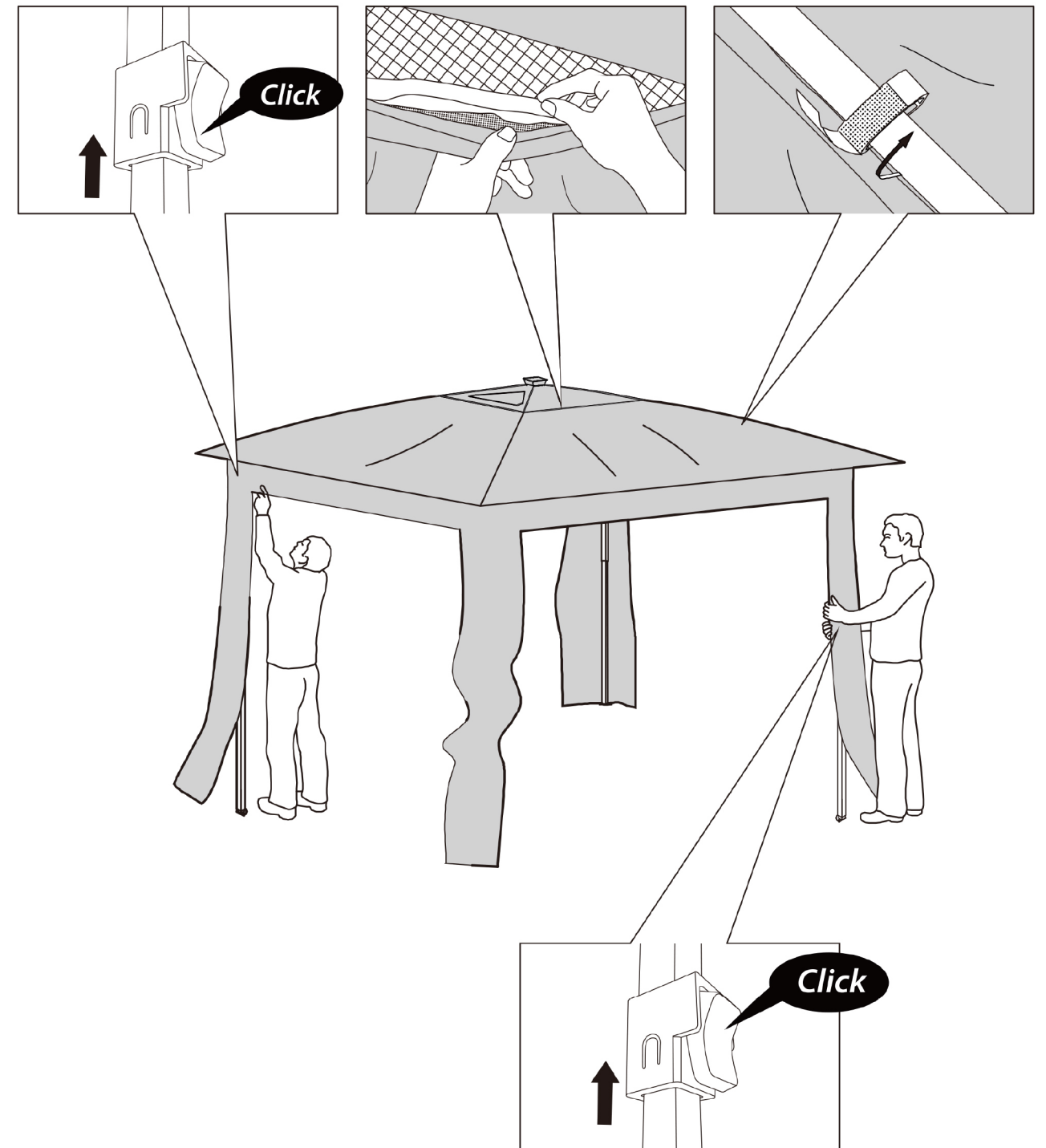

INSTALL MOSQUITO NET ACROSS THE OUTSIDE OF LEG ASSEMBLY

Step 4

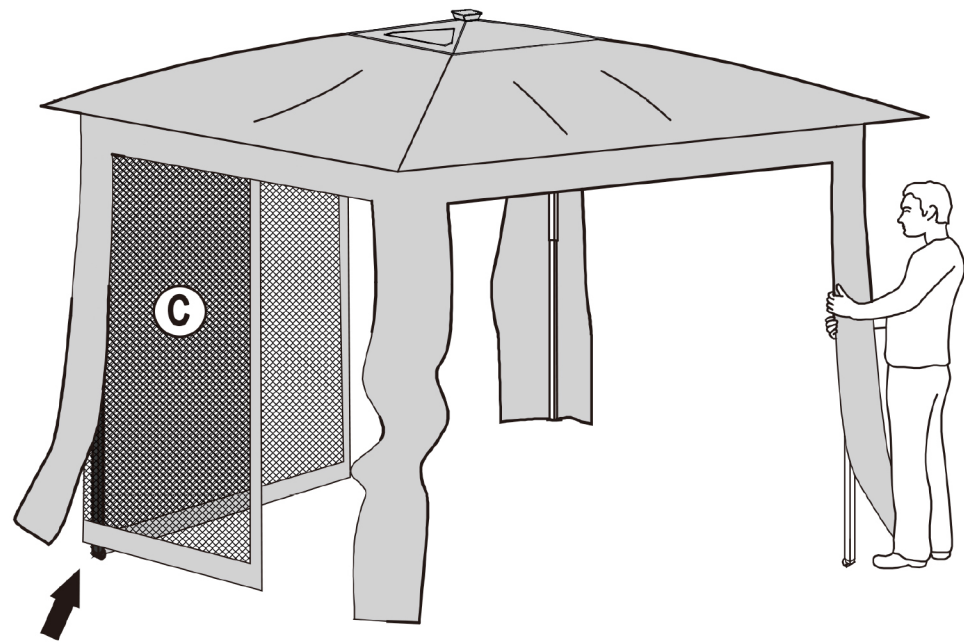
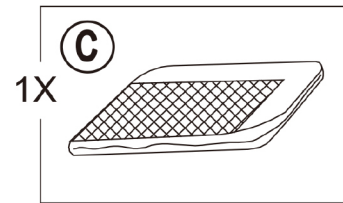

Install mosquito net across the outside of leg assembly

ATTACH THE MOSQUITO NETTING

Step 5

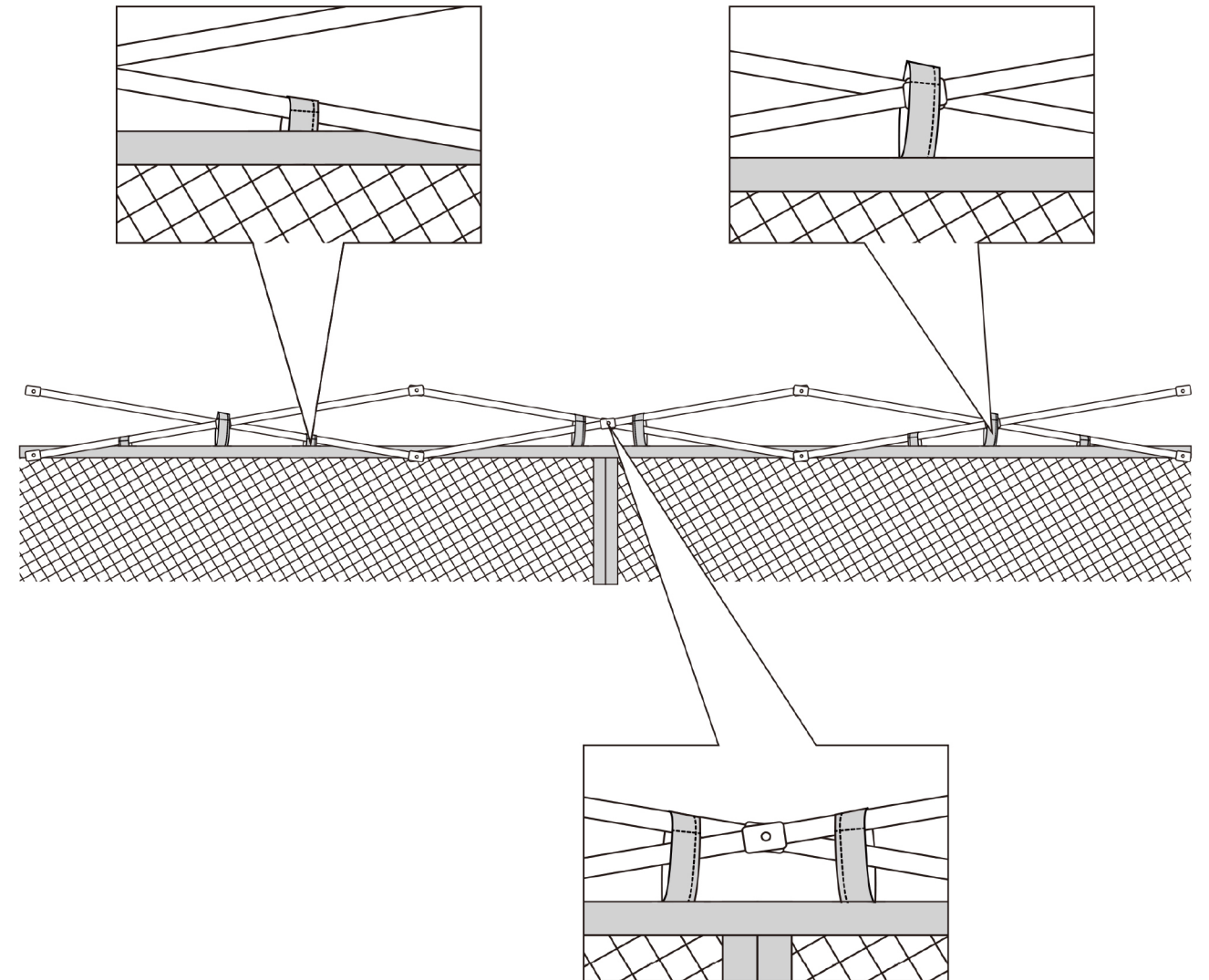

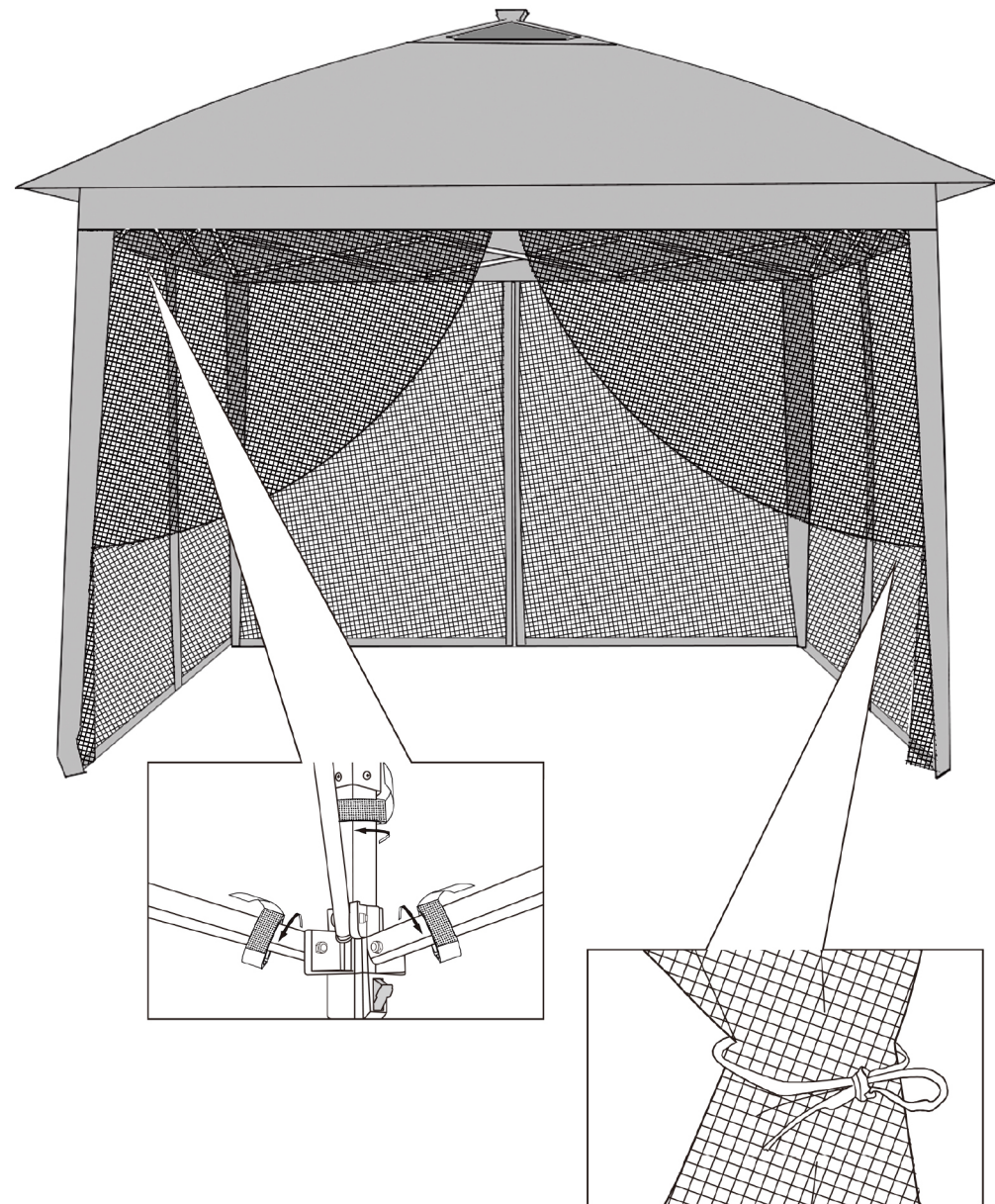

SECURE THE CANOPY IN PLACE

Step 6

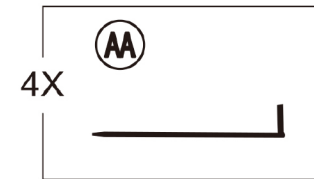

The place is paenty of sunshine

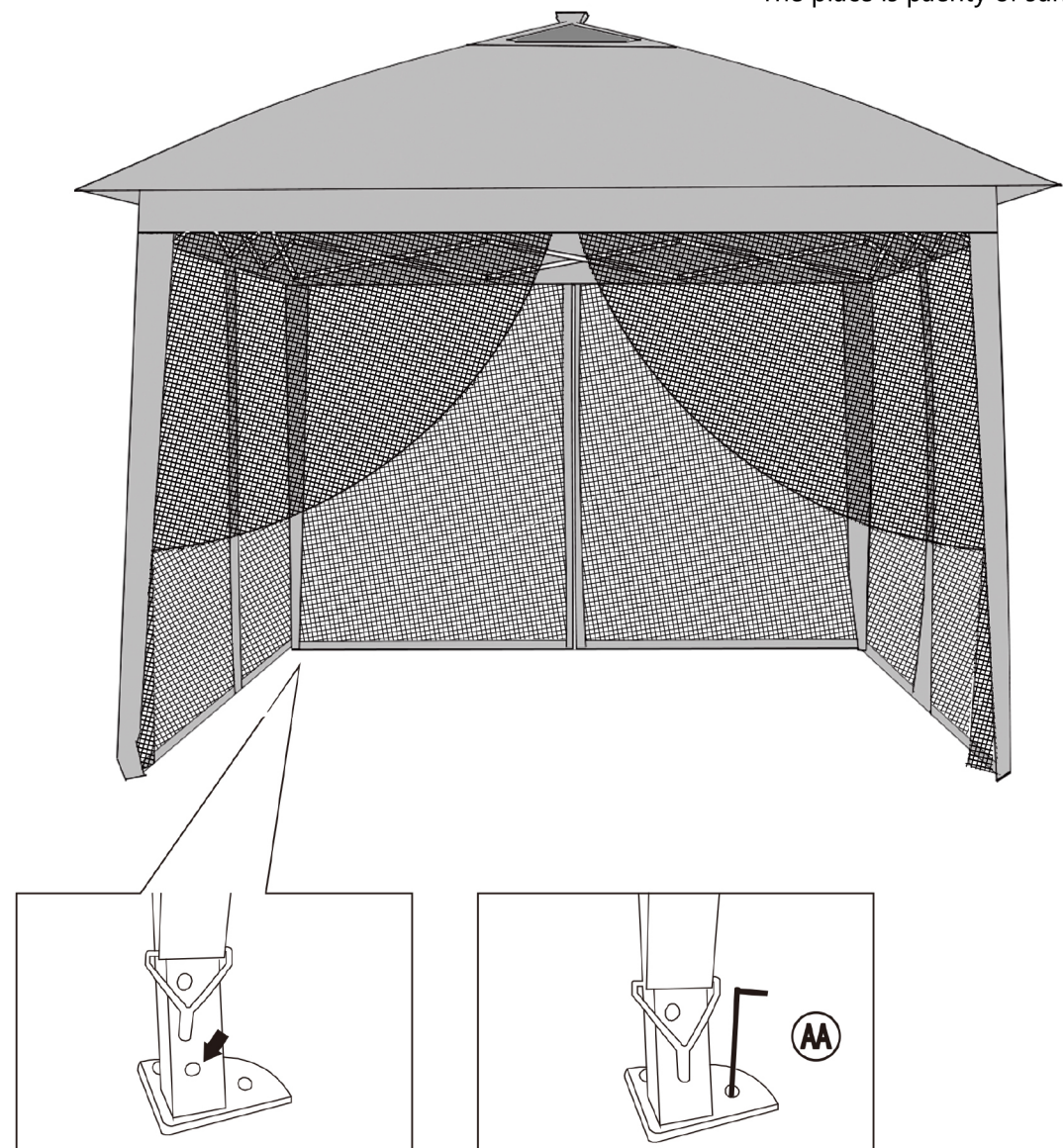

SECURE THE CANOPY IN PLACE

Step 7

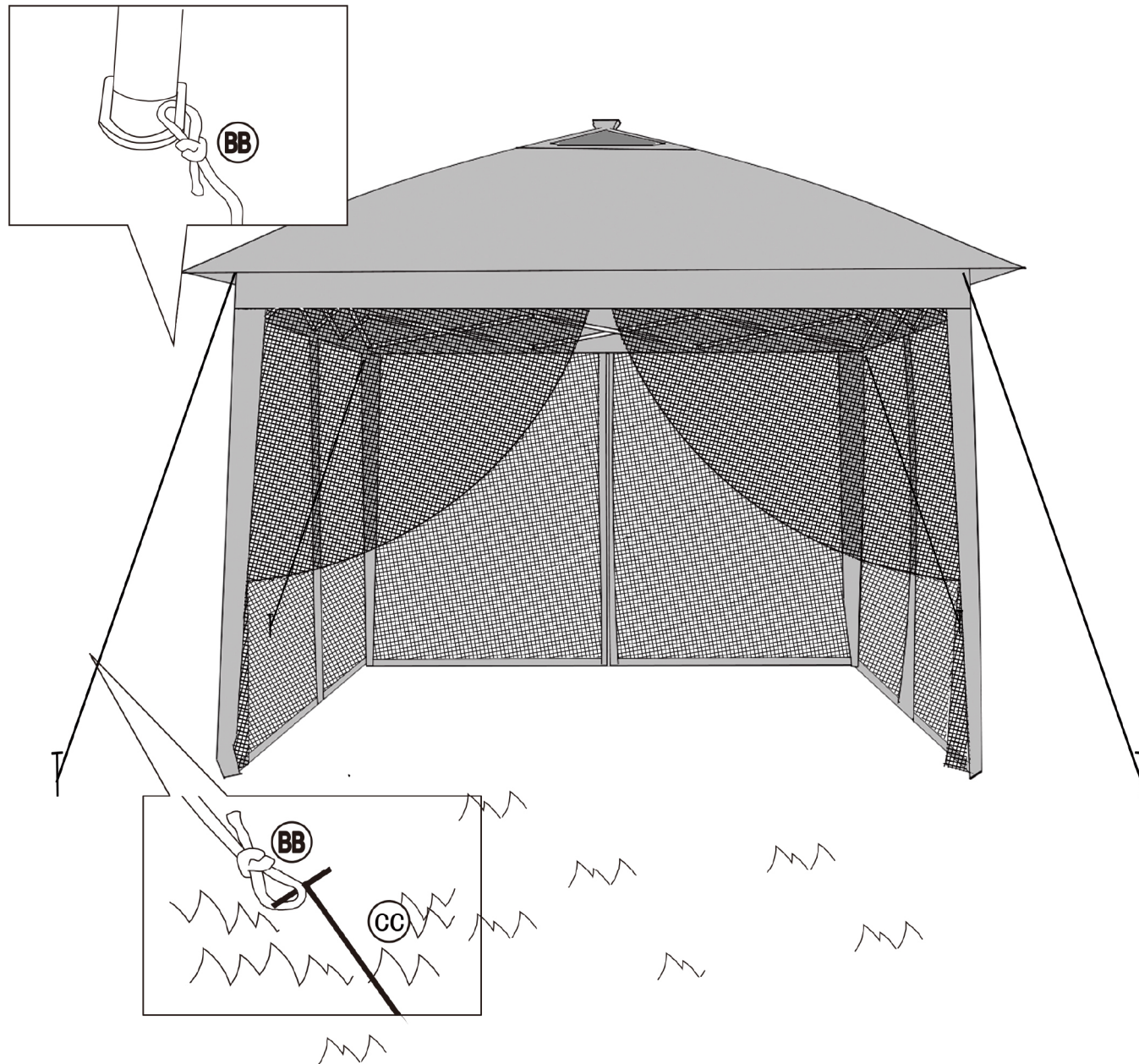
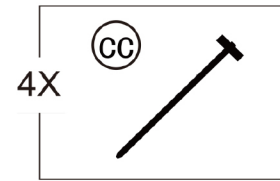
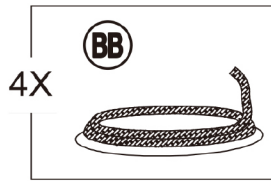
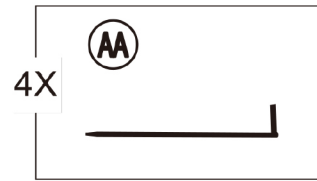

TAKE DOWN THE CANOPY

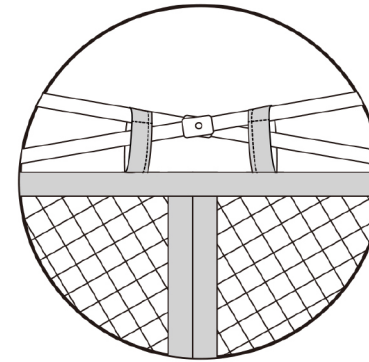

1 Remove the mosquito netting if attached.

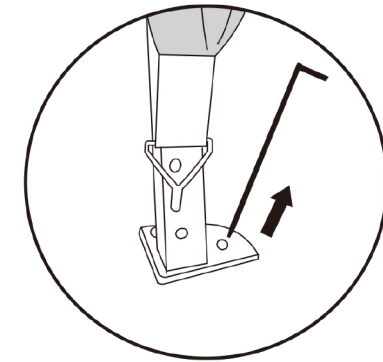

2 Pull up all stakes from the ground.

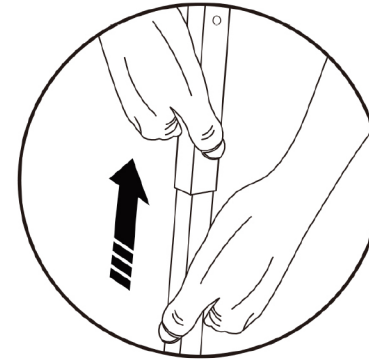

3 Press the push pin on each leg and retract the legs to their original height.

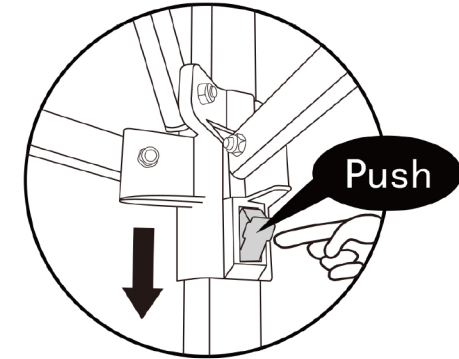

4 Push the push button on each slider to unlock the frame.

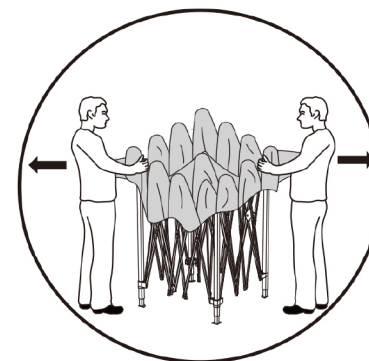

5 Push inward until the frame is fully closed.

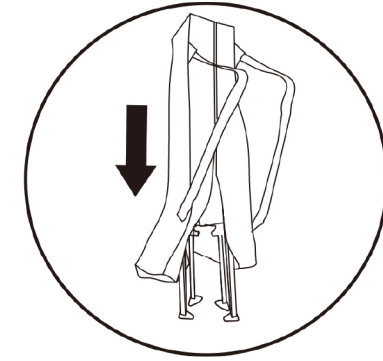

6 Slide the carry bag over the closed frame and close the zipper on carry bag.