

Assembly Instructions

Caution: You must read this before you proceed

ADIRONDACK

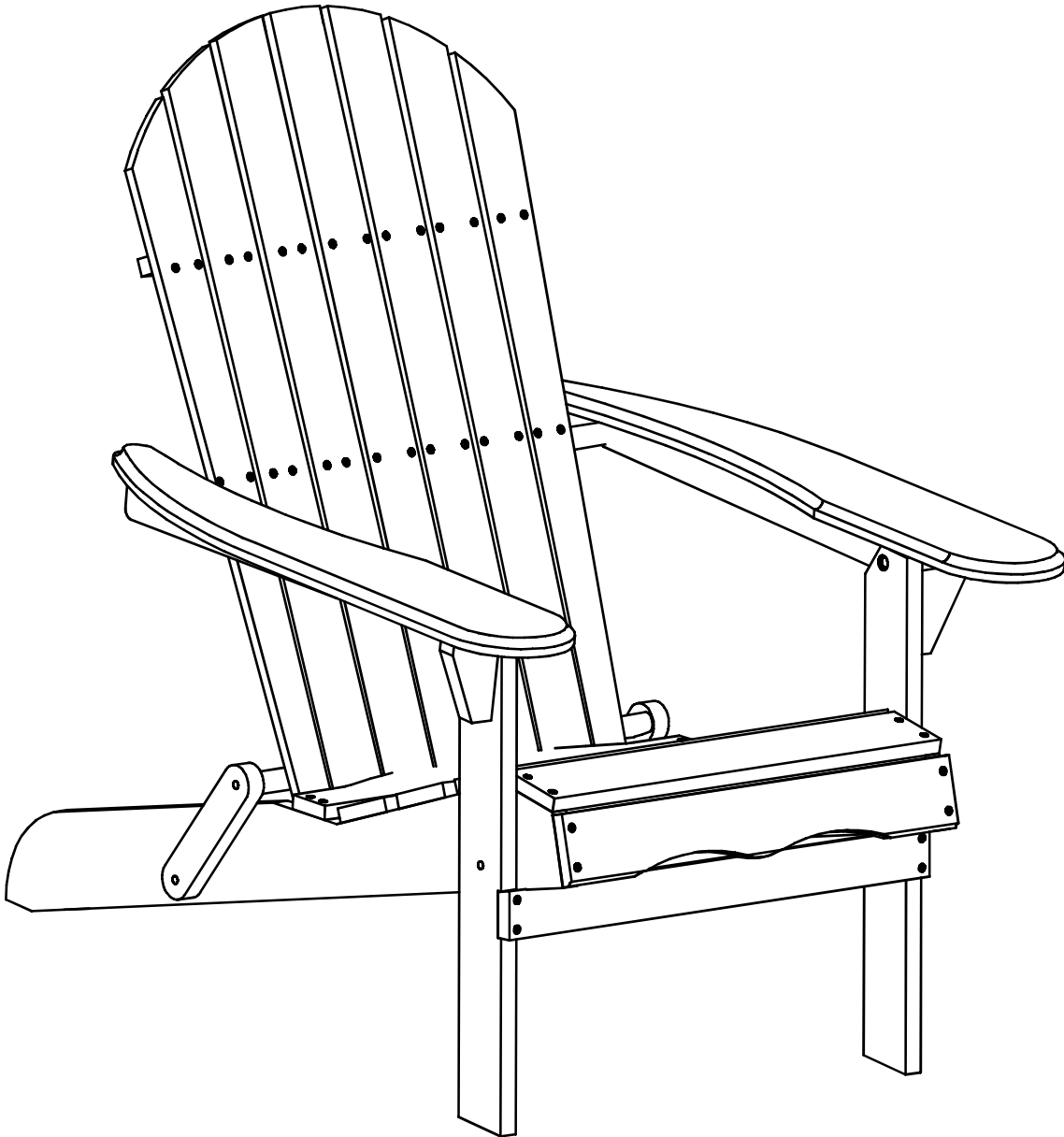

CAUTION : This Adirondack is NOT a TOY.







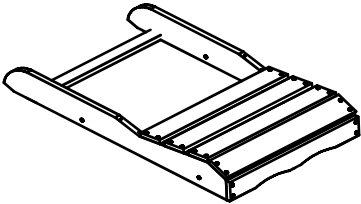
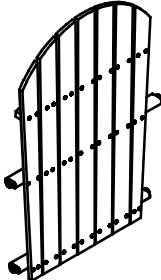
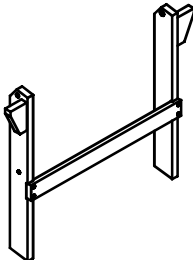
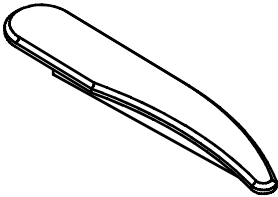
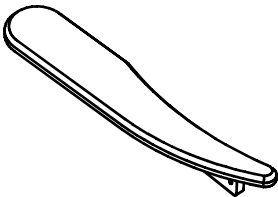
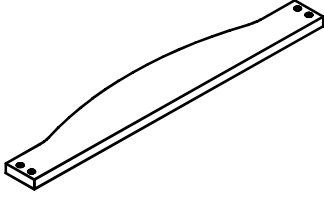
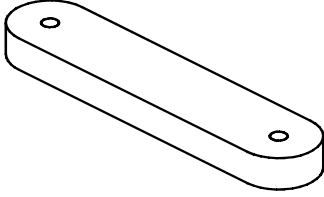

Keep your child / children at bay during the assembly process.

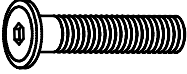
For moving the Adirondack and to prevent damage to the Adirondack, two adults are needed to execute this action.

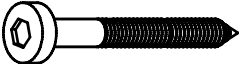
Parts List

Label	Picture	Description	QTY
A	 A perspective view of a rectangular seat panel with a ribbed surface and a slightly raised front edge.	Seat Panel	1
B	 A perspective view of a curved backrest with vertical slats and a curved top edge.	Backrest	1
C	 A perspective view of a pre-fixed front leg, showing a horizontal bar connecting two vertical legs.	Pre-fixed Front Leg	1
D	 A perspective view of a curved left armrest.	Left Armrest	1
E	 A perspective view of a curved right armrest.	Right Armrest	1
F	 A perspective view of a KD Slat, a long, thin, curved piece of material.	KD Slat	1
G	 A perspective view of a folding support bar, a long, thin, curved piece of material with two circular holes.	Folding Support Bar	2





Parts List

Label	Picture	Description	QTY
①		Bolt (M8x35)	7
②		Sleeve Nut (M8x15)	7
③		Long Screw (M7x70)	3
④		Short Screw (M7x40)	3
⑤		Screw (M4x30mm) (Use with Screwdriver)	5
⑥		Plastic Washer	7
⑦		Allen Key	2
⑧		Screwdriver	Not provided

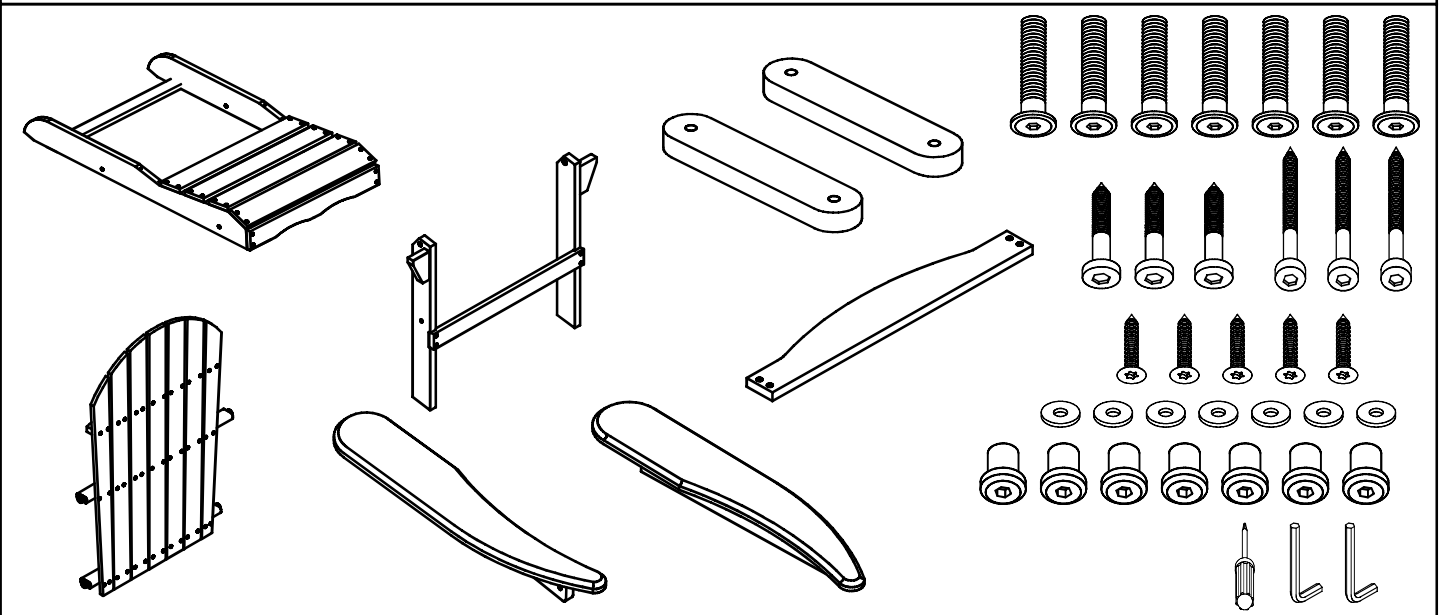
Assembly Preparation

Before Beginning Assembly:



-  • Read instructions, cover to cover-
-  • Have 2 adults on hand for assembly-
-  • Do not assemble on flooring or carpet-
-  • Assemble on a clean non-marring surface (packing foam)-
-  • Save all packaging until finished-

Assembly Steps

OVERVIEW

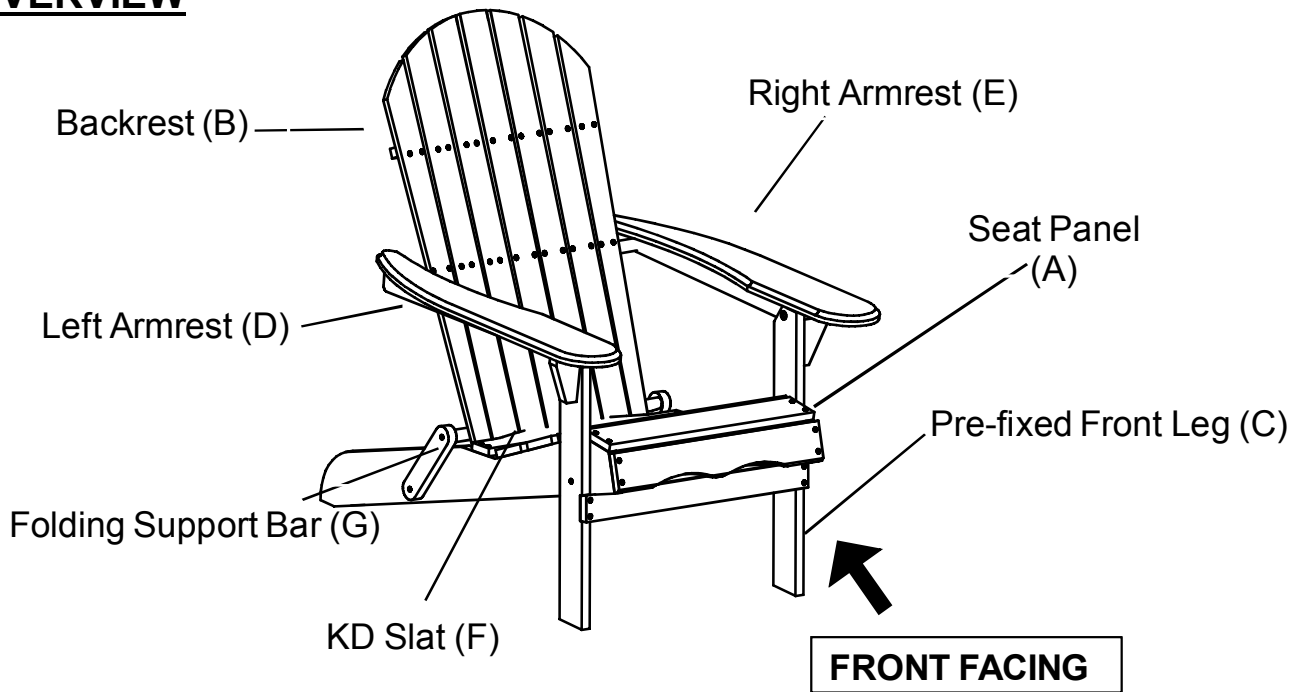

This Adirondack has multiple parts and may require up to 30 minutes to assemble. To give you an overview of the Adirondack parts, the above picture is to help you put the various parts into perspective. Please read through the instructions below to familiarise yourself with the parts and steps before assembly.

Step 1

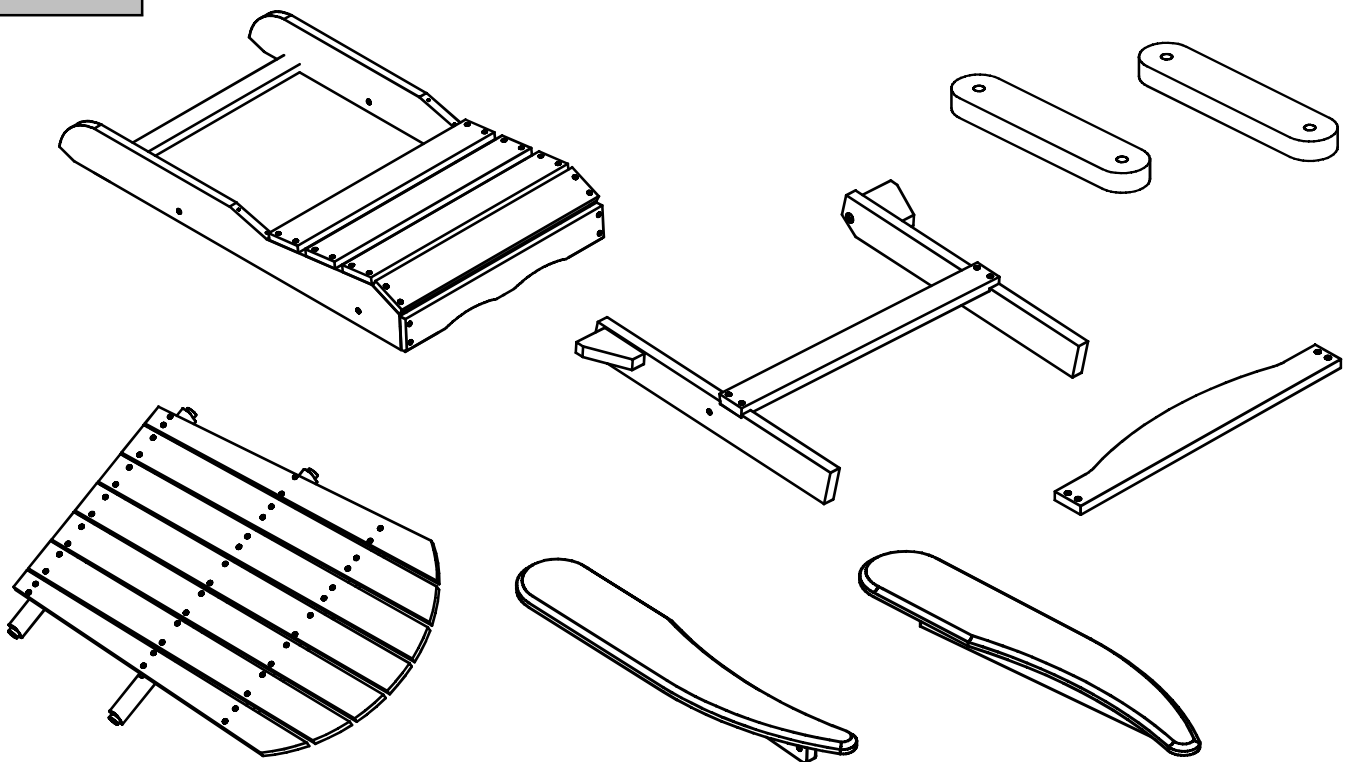

Unpack and place all parts on a clean, non-marring surface.

Step 2

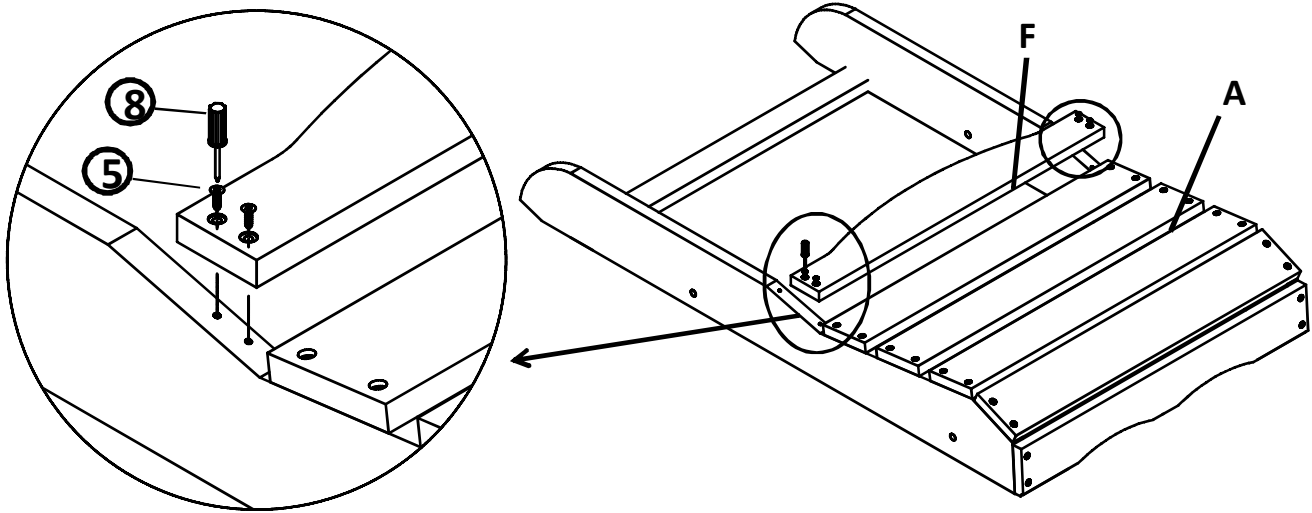

Place the Seat Panel(A) onto a clean, non-marring surface.
Position KD Slat(F) onto the Seat Panel(A) and attach using 4 Screws(5) and Screwdriver(8)

Step 3

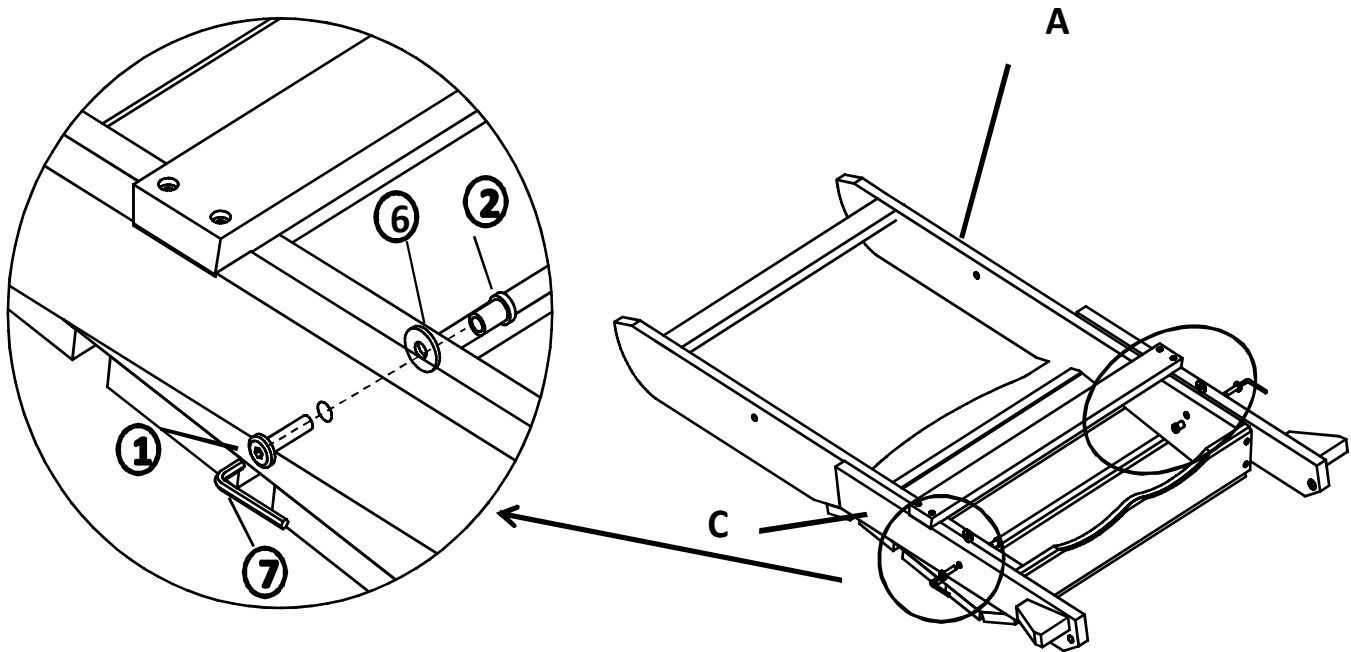

Place the Seat Panel(A) as shown in the picture.
Attach Pre-fixed Front Leg(C) to Seat Panel(A) using Bolts(1), Plastic Washers(6), and Sleeve Nuts(2) with Allen Keys(7)

Do not fully tighten Bolts

Note: The Plastic Washer should be placed between the Seat Panel and Pre-fixed Front Leg.

Step 4

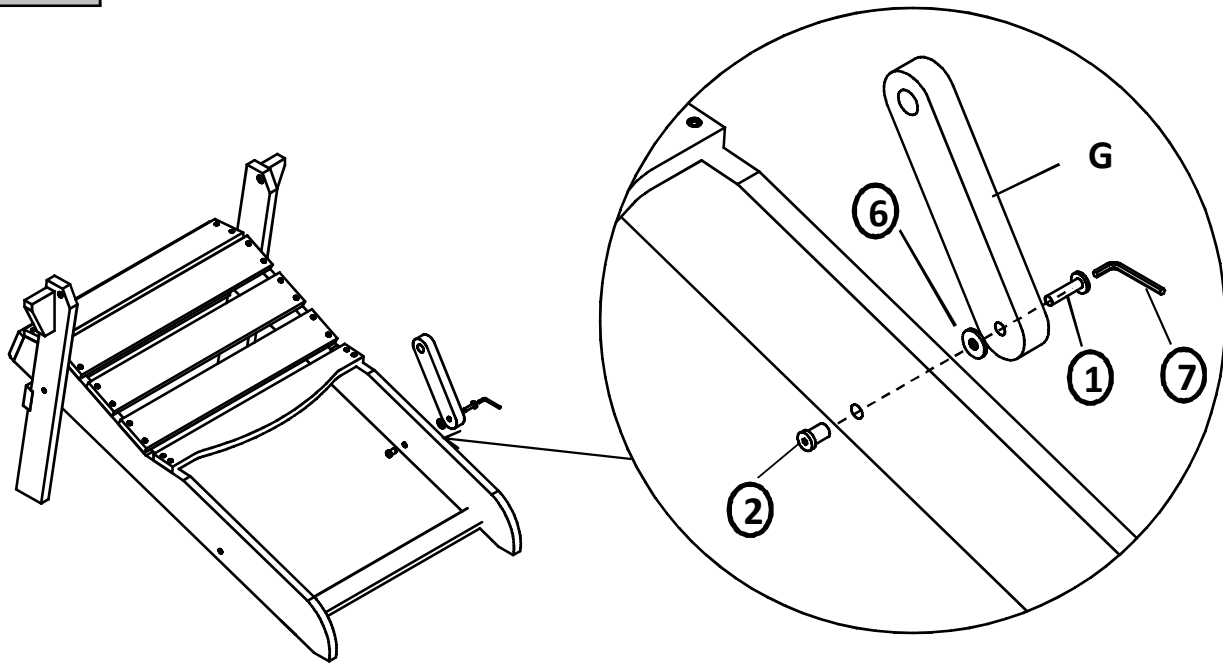

Place the Frame in Step 3 in the position as picture above
Attach Folding Support Bar(G) to Seat Panel(A) using Bolt(①), Plastic Washer(⑥), and Sleeve Nut(②) with Allen Keys(⑦).

Do not fully tighten Bolts.

Note: Plastic Washer should be placed between Seat Panel and Folding Support Bar.

Step 5

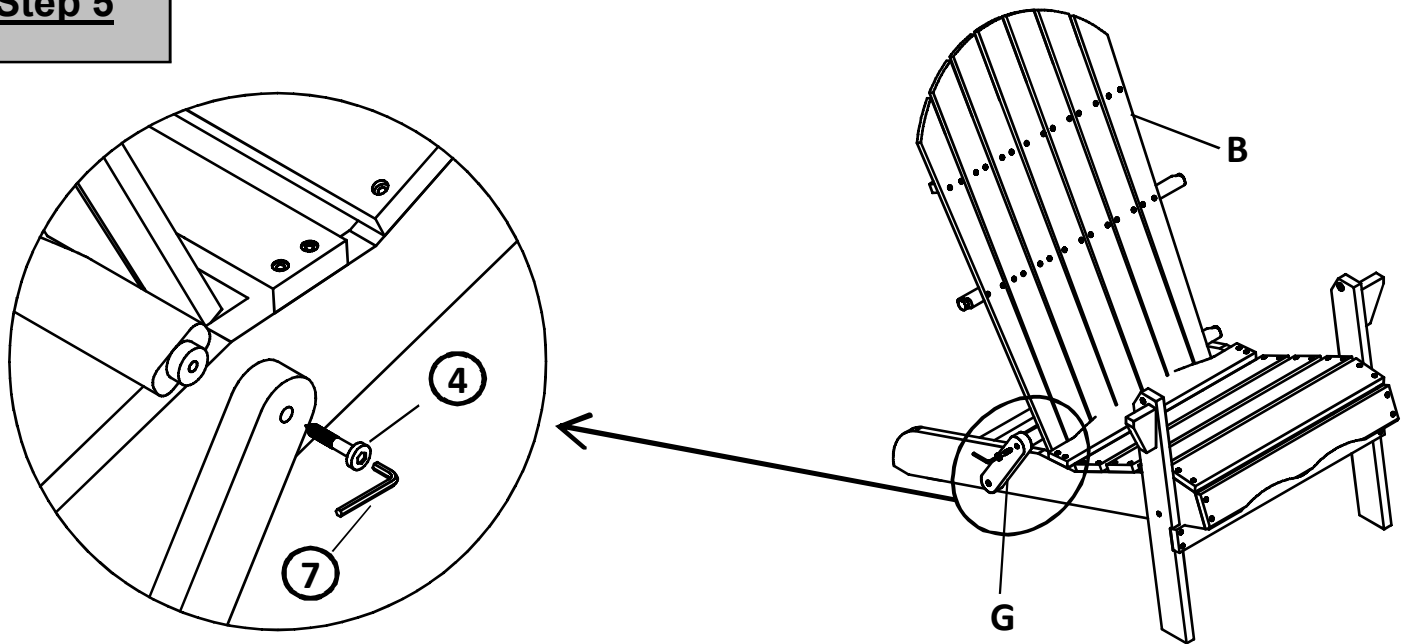

Position Backrest (B) with mortise into housing of Folding Support Bar (G)
Secure Folding Support Bar(G) to Backrest(B) using Short Screw(④) with Allen Key(⑦).

Do not fully tighten Screws

Repeat the same process with the second Folding Support Bar(G).

Step 6

Step 6.2

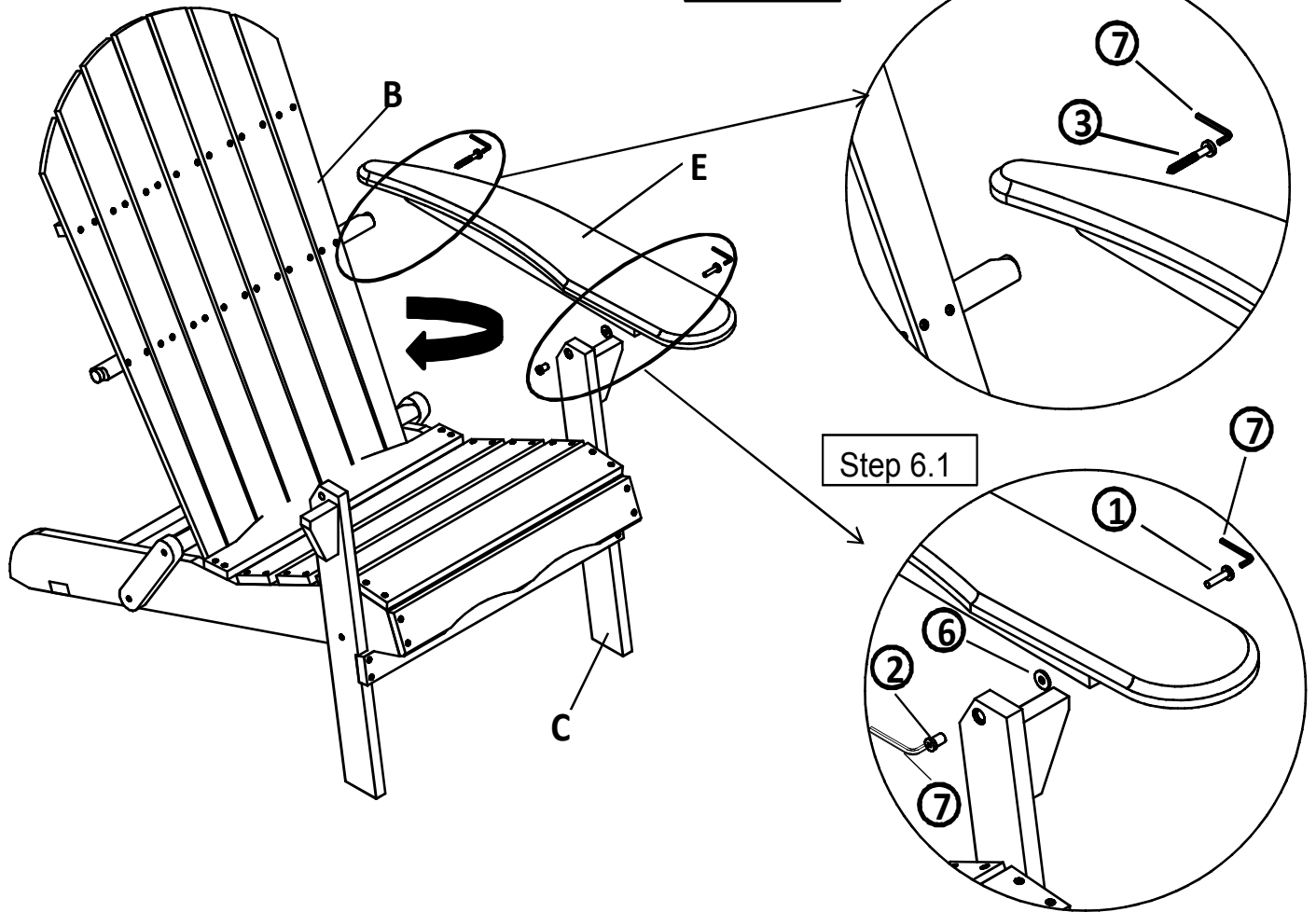

Step 6.1

Open Backrest(B) as indicated with the arrow.

6.1) Secure Left Armrest(D) to Pre-fixed Front Leg(C) by using Bolt(①), Plastic Washer(⑥), and Sleeve Nut(②) with Allen Keys(⑦).

6.2) Secure Left Armrest(D) to Backrest(B) using Long Screw(③) with Allen Key(⑦).

Do not fully tighten Bolts and Screws.

Note: Plastic Washer should be placed between Left Armrest and Pre-fixed Front Leg.

Repeat the same process with the Right Armrest(E).

In a sequential manner, tighten all Bolts and Screws at all joints until fully locked into position.

Step 7

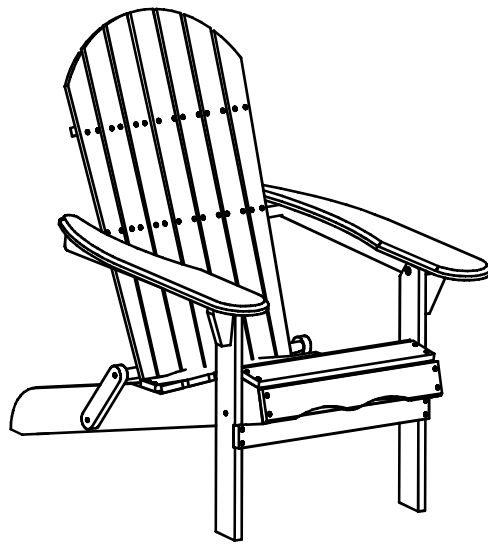

Your Adirondack is ready for use.

This Adirondack can only be used on a flat, level surface.

Step 8

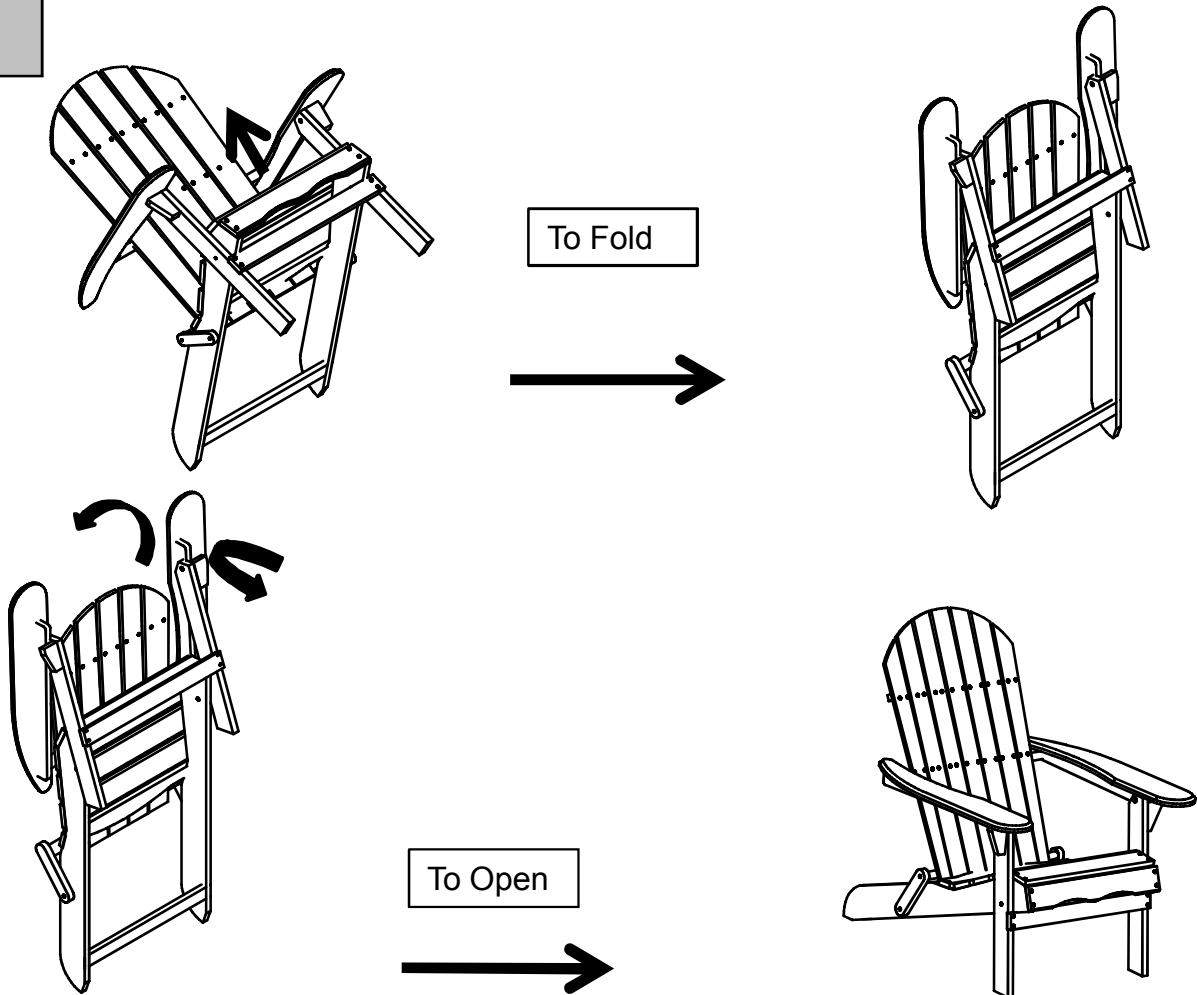



















This Adirondack can be folded shut.

To fold this Adirondack, raise up Backrest and fold Seat with Leg Frame as indicated by the arrows, by hand, until the Adirondack folds shut

To open this Adirondack, open Backrest and Seat as indicated by the arrows, by hand until the Adirondack folds out and locks into position.

Note: This Adirondack is slightly heavy, do exercise caution to avoid injury.

Care & Maintenance

-   ● Do not put hot items directly on furniture surface
 -   ● Do not clean furniture with harsh cleansers or polish.
 -   ● To obtain the longest lifespan of your outdoor products, minimizing exposure to direct sunlight is recommended.
 -   ● Children should not climb or jump on the furniture.
 -   ● Do not write on furniture without a padded barrier to protect the surface.
 -   ● To obtain the longest lifespan of your outdoor products, avoid extended and lengthy exposure to rain, snow, and direct sunshine. Whenever possible cover the product and /or place under patio or awnings.
 -   ● Not for commercial use. For residential use only .
 -   ● Stains may be removed with mild soap solution and damp cloth.
-
-   ● Dust and pick-up spills using a clean, non-colored, lint-free cloth .

What is Proposition 65?

Proposition 65 is a California law that requires warning labels on products that may contain one of more than 800-plus chemicals or ingredients that the California Office of Environmental Health Hazard Assessment (OEHHA) has deemed to cause cancer or other reproductive toxicity. Chemicals and elements on this list include wood dust, brass, and other everyday substances, which can be found in very common household items, such as: lamps, tableware, jewelry, crystal glasses, electric cords, beauty products, automobiles, and furniture.

Why Did I Find a Proposition 65 Warning on My Home Goods Product?

We include Proposition 65 warnings on all of our products because there is always a chance that one of the 800-plus common chemicals and ingredients listed under this law could potentially be on our furniture or packing materials. We risk large fines under this law, if we don't include this warning.

Should I worry?

We realize you may be worried finding this warning on our products, but we want to reassure you that the hazardous exposure limits for any of these chemicals have never been found on furniture products that we've shipped to our customers. Additionally, this warning label is very common and can be found on almost every piece of furniture sold in the state of California.

Just How Common Are Proposition 65 Warnings?

Proposition 65 warnings have become so common in California that it is hard to take a trip to a local bank, grocery store, or restaurant without finding at least one warning. In fact, even the Disney Land Resort has a Proposition 65 warning:

