

WINE CABINET

ASSEMBLY INSTRUCTION



ASSEMBLY INSTRUCTION

Assembly Instruction

ASSEMBLY TIPS:

1. Remove hardware from box and sort by size.
2. Please check to see that all hardware and parts are present prior to start of assembly.
3. Please follow attached instructions in the same sequence as numbered to assure fast & easy assembly.

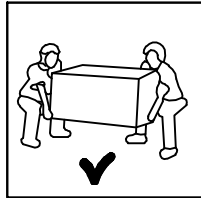
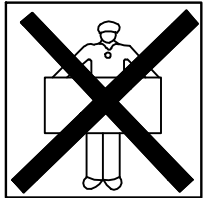

⚠ Warning!

1. Don't attempt to repair or modify parts that are broken or defective. Please contact the store immediately.
2. This product is for home use only and not intended for commercial establishment.





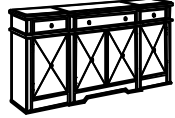

ASSEMBLY TIME PER UNIT: 15 MINUTES

PARTS IDENTIFICATION

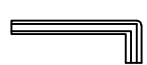
A	wine cabinet		1PC
B	LEG		6PCS

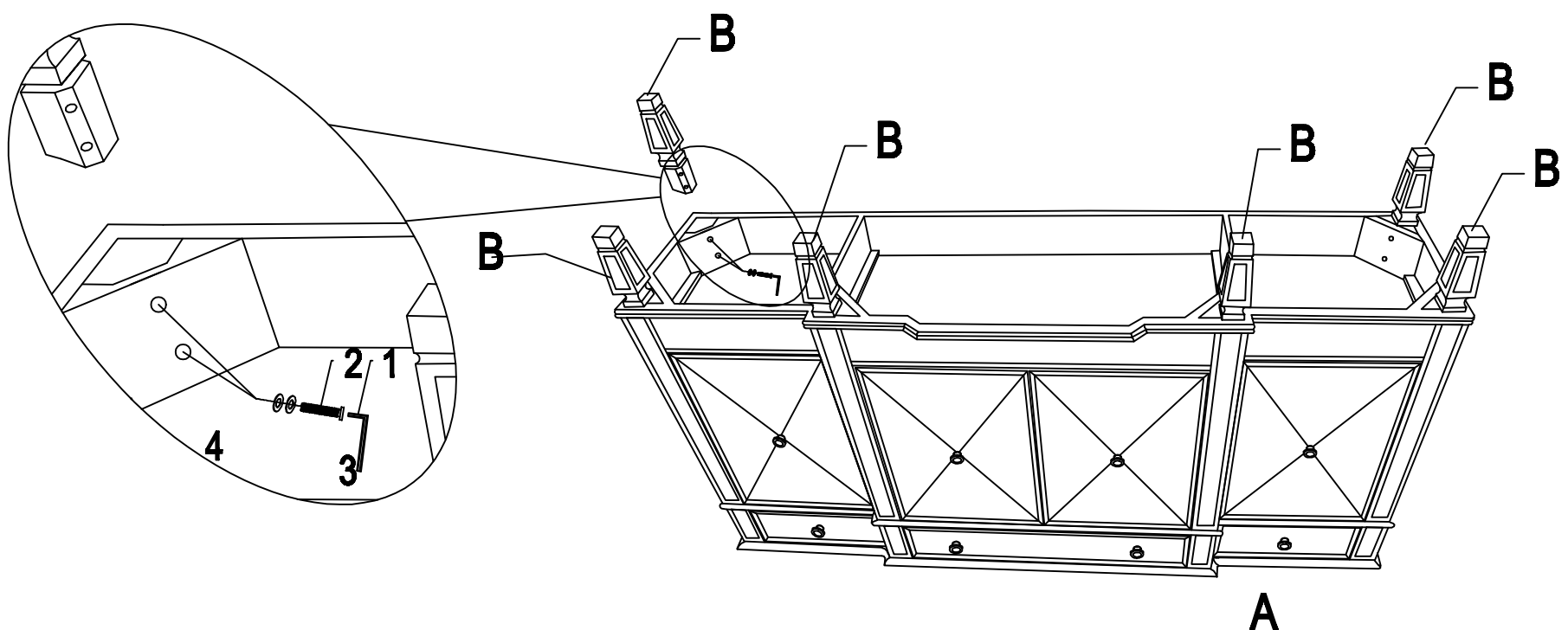

Z HARDWARE IDENTIFICATION

NO	DESCRIPTION	FIGURE	SIZE	QTY
1	ALLEN KEY		5mm	1PC
2	BOLT		Ø8*40mm	12PCS
3	SPRING WASHER		Ø8mm	12PCS
4	FLAT WASHER		Ø8mm	12PCS

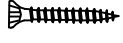

ASSEMBLY INSTRUCTION

Please install the Anti tipping hardware as shown in the drawing - this can help to prevent any tipping issues.

Z HARDWARE PACKAGE				
NO.	DESCRIPTION	FIGURE	SIZE	QTY
1	PLUG			2PCS
2	LARGE SCREW		Ø8x2"	1PC
3	TIGHTWIRE			1PC
4	SHORT SCREW		Ø8x3/4"	1PC

ATTENTION: Anti tipping safeguard

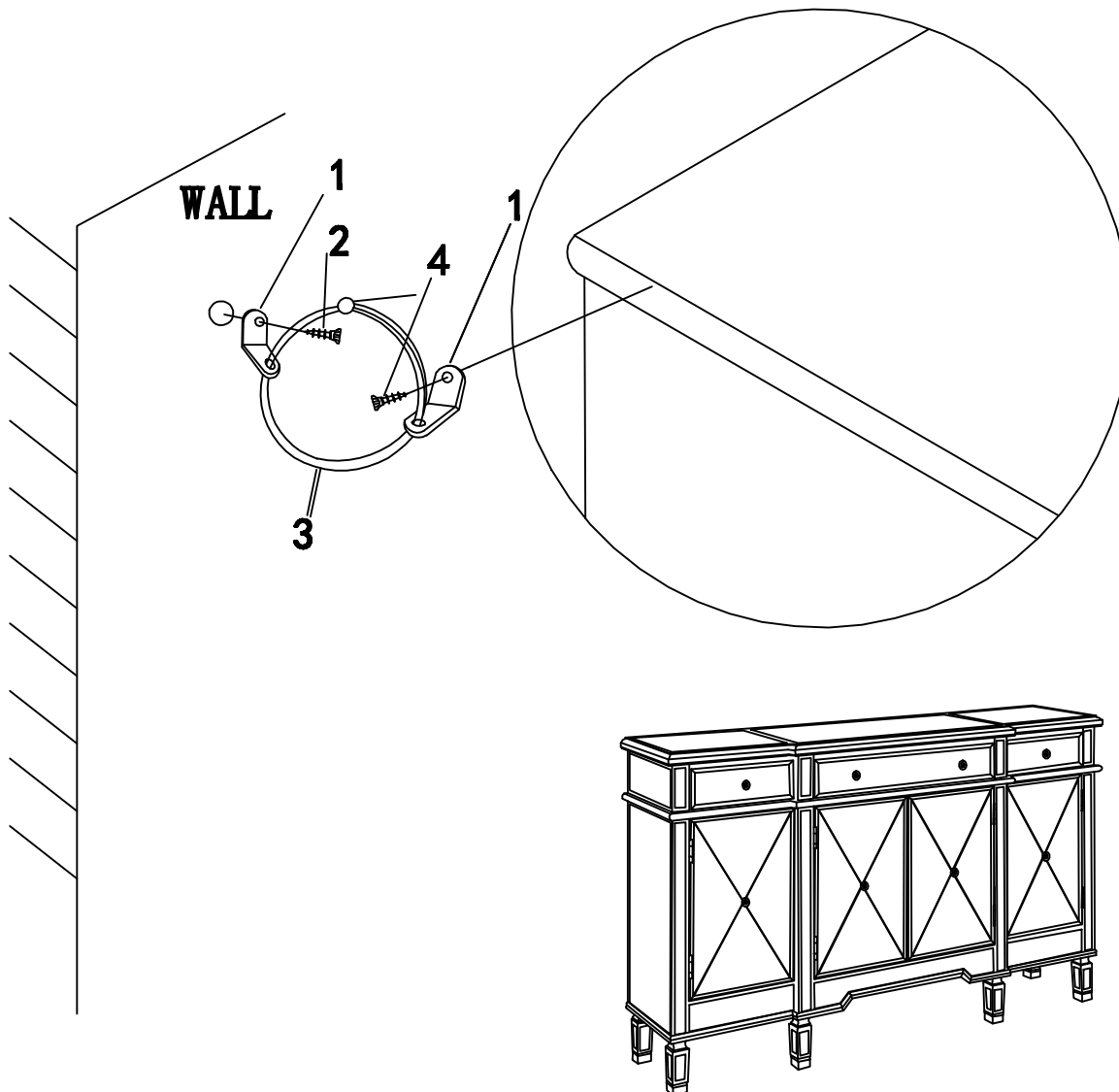

FURNITURE TIPPING RESTRAINT

WARNING

Injury may result from tipping furniture
 This restraint is not a substitute for proper adult supervision
 This restraint may provide protection against tipping furniture.
 Do not allow children to climb on furniture.
 Failure to detach this restraint before moving furniture may
 result in injury and damage