

OFFICE CHAIR ASSEMBLY INSTRUCTION

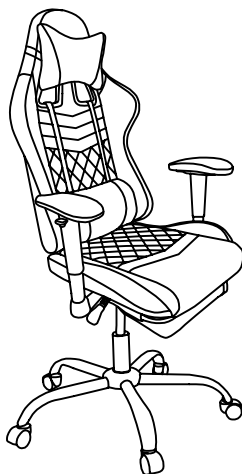

THANK YOU FOR PURCHASING OFFICE CHAIR

PARTS LIST

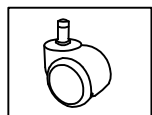

A 5×Wheels

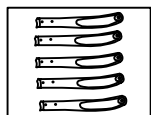

B15×Split base
tube

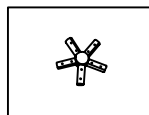

B2 1×Central
base tube



B31×base cover

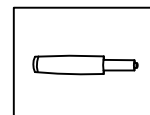

C1 1×gas lift

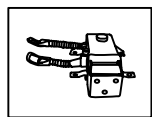

D1×mechanism



E 1×seat

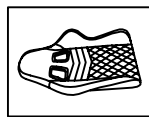

F 1×back

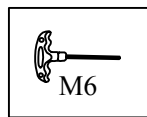

H 1×allen key

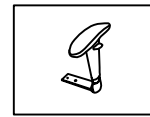

I 1 Left armrests

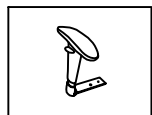

I2 Right armrests

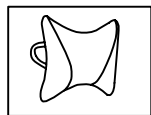

J1 1×headres

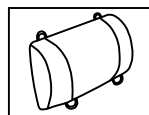

J2 1×Adjustable
Lumber Suppor

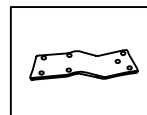

N1 1×Steel plate

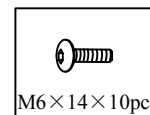

M6×14×10pcs
Z2 10×screws

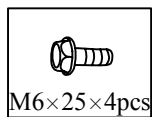

M6×25×4pcs
Z13 4×screws

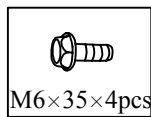

M6×35×4pcs
Z26 4×screws

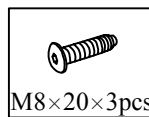

M8×20×3pcs
Y26 3×screws

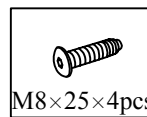

M8×25×4pcs
Y8 4×screws

WARNING

- Do not stand in this chair or use the chair as a step ladder use it as chair only.
- This chair is designed for one person to use at a time.
- This chair is designed for one person weighing up to 250lbs(113kgs).
- Do not use this chair unless all bolts, screws and knobs are firmly secured.
- Check all bolts,screws and knobs every 90days. Tighten if any are loose.
- Failure to follow these instructions may result in serious injury or death of yourself and people around you.
- Some of the part are heavy and/or has shape edge, please install it carefully to avoid hurt you and people around you.

1

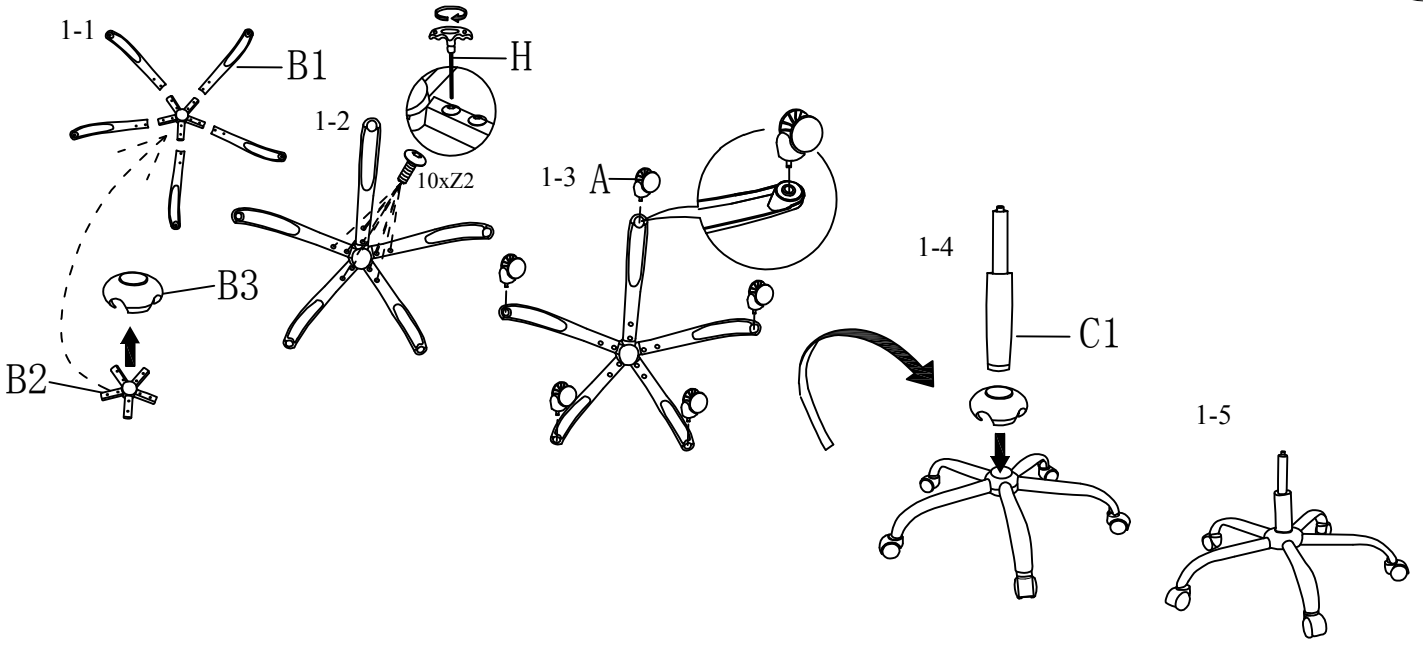

2

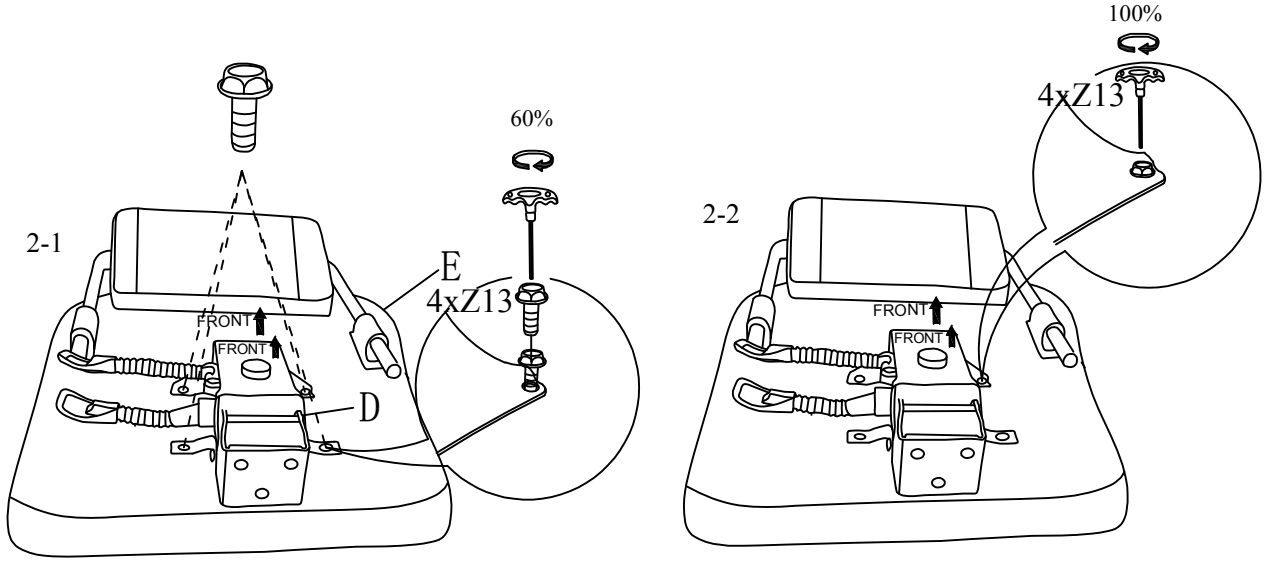

Please do not tight the screw until all screw lined up with hole and try to tight it loosely initially in all screws then tight a little bit more in all screws do not overnight one screws that will make other screw hard to tight but tight all screw firmly in the end

3

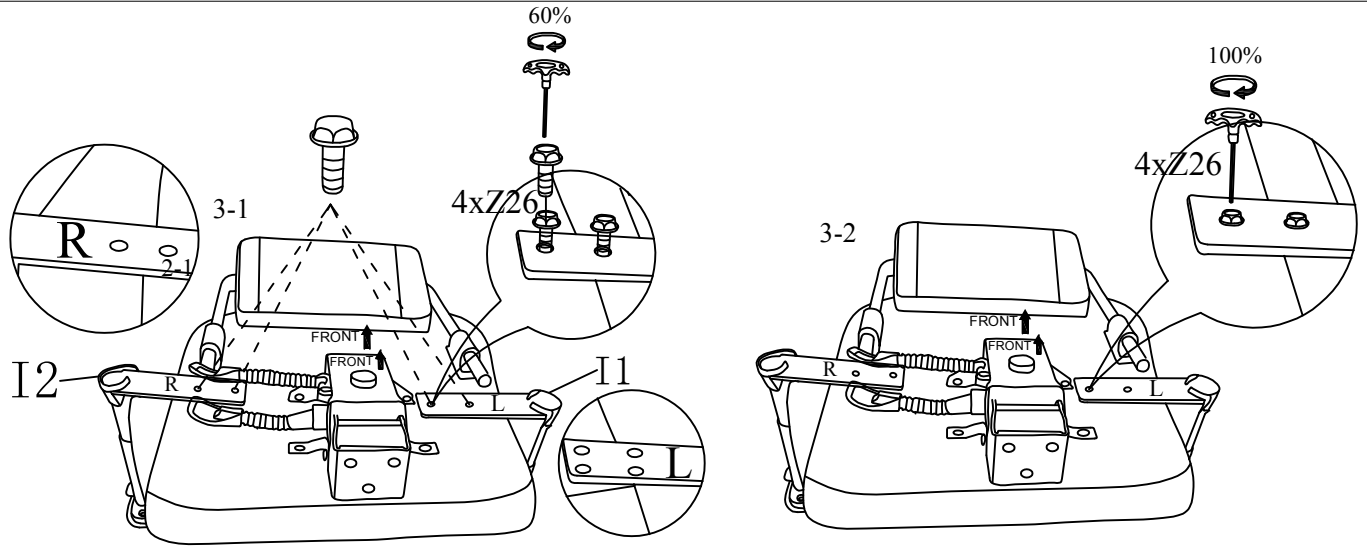

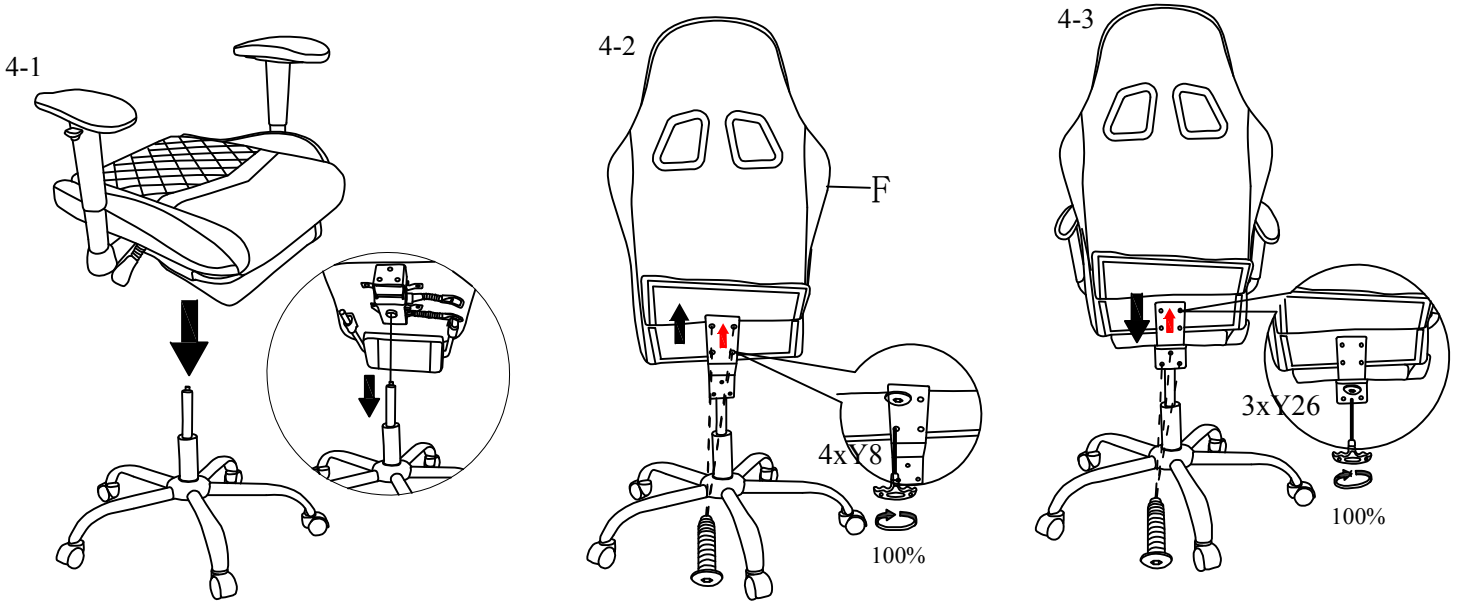

NOTICE Do not tighten the bolts before the product is fully assembled.

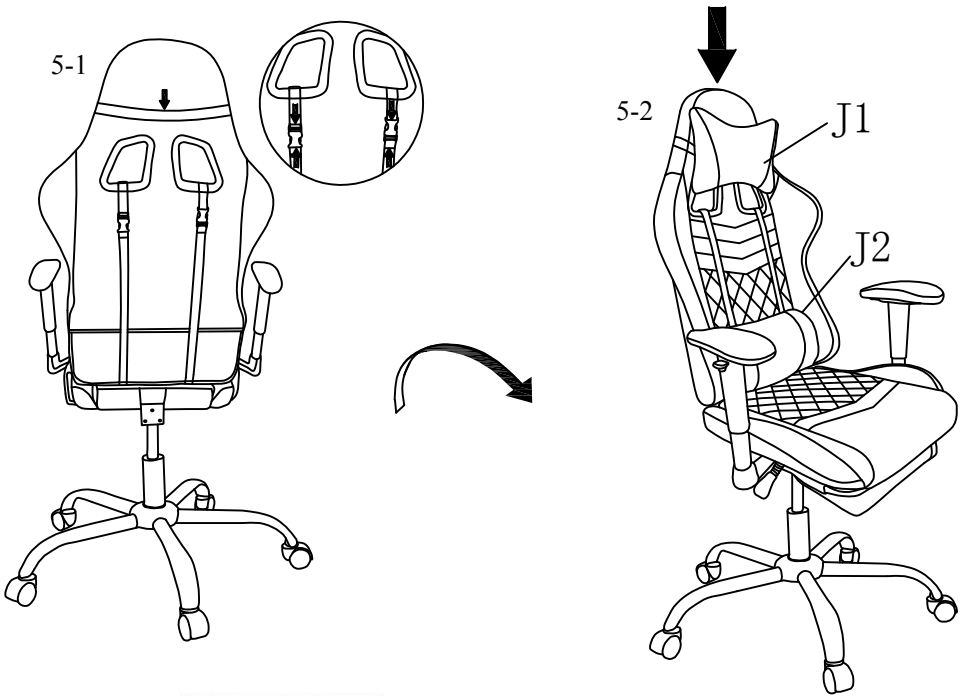

NOTICE Tighten all the bolts after full assembly.



7

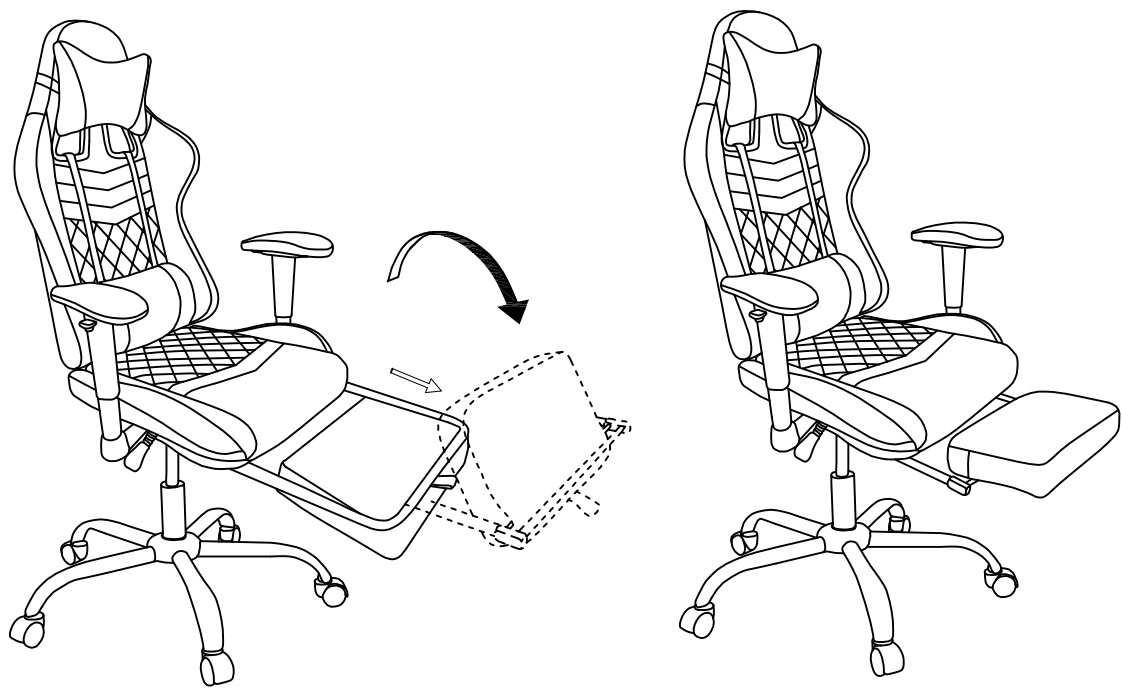

8

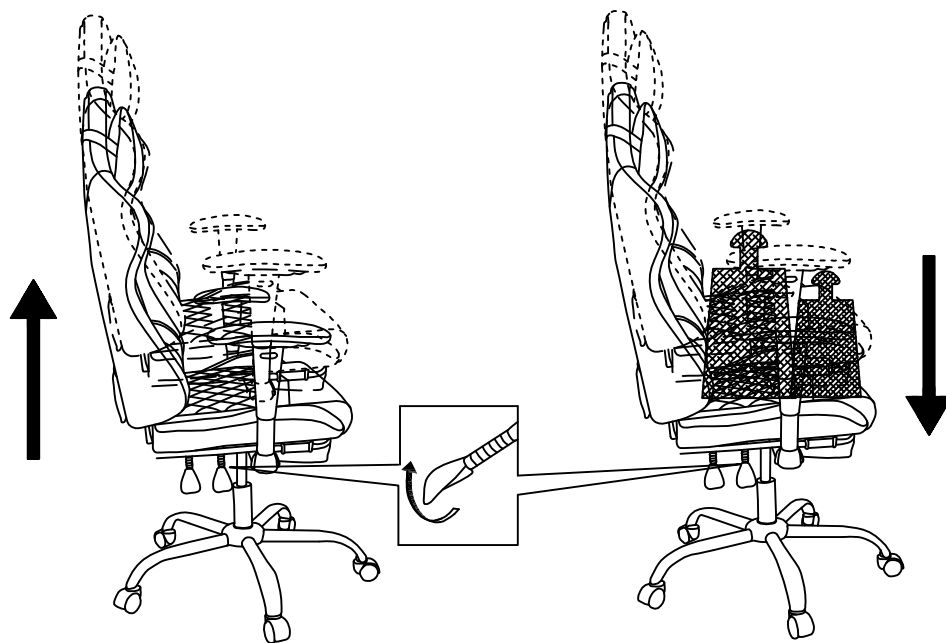

There's a circle under the chair if you turn it, it will lessen the force required to the lean back in the chair

9

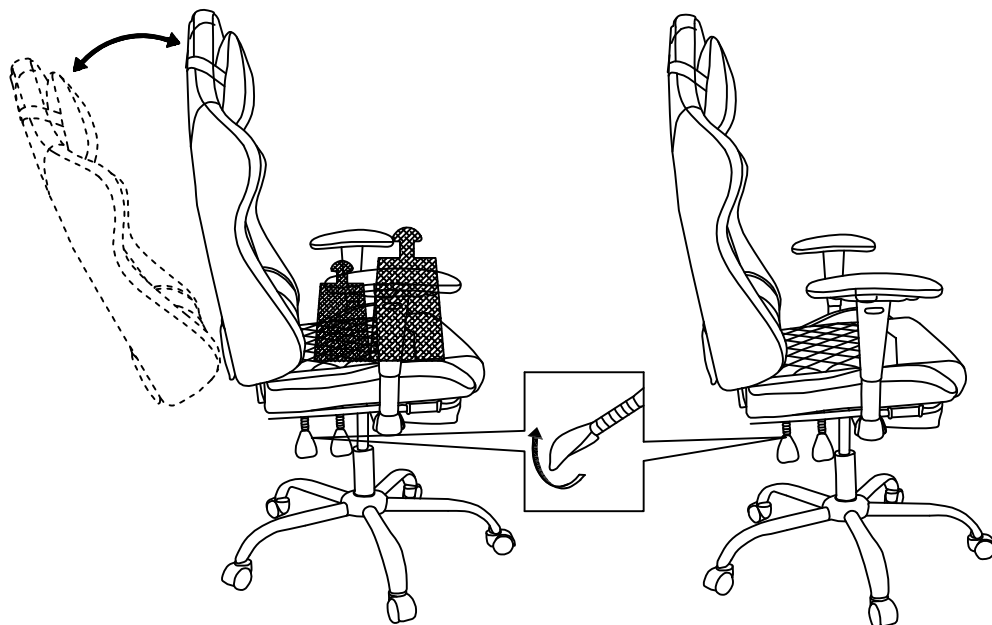

This chair will not lay flat but can recline. in order to recline. please null the handle on the side out