

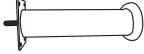

ASSEMBLY INSTRUCTION

Please follow below Assembly Procedures step by step.

HARDWARE LIST			
NO.	DESCRIPTION		QTY (pcs)
A	 leg		8
B	 screw		32
C	 Armrest		4

STEP1

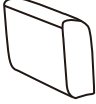
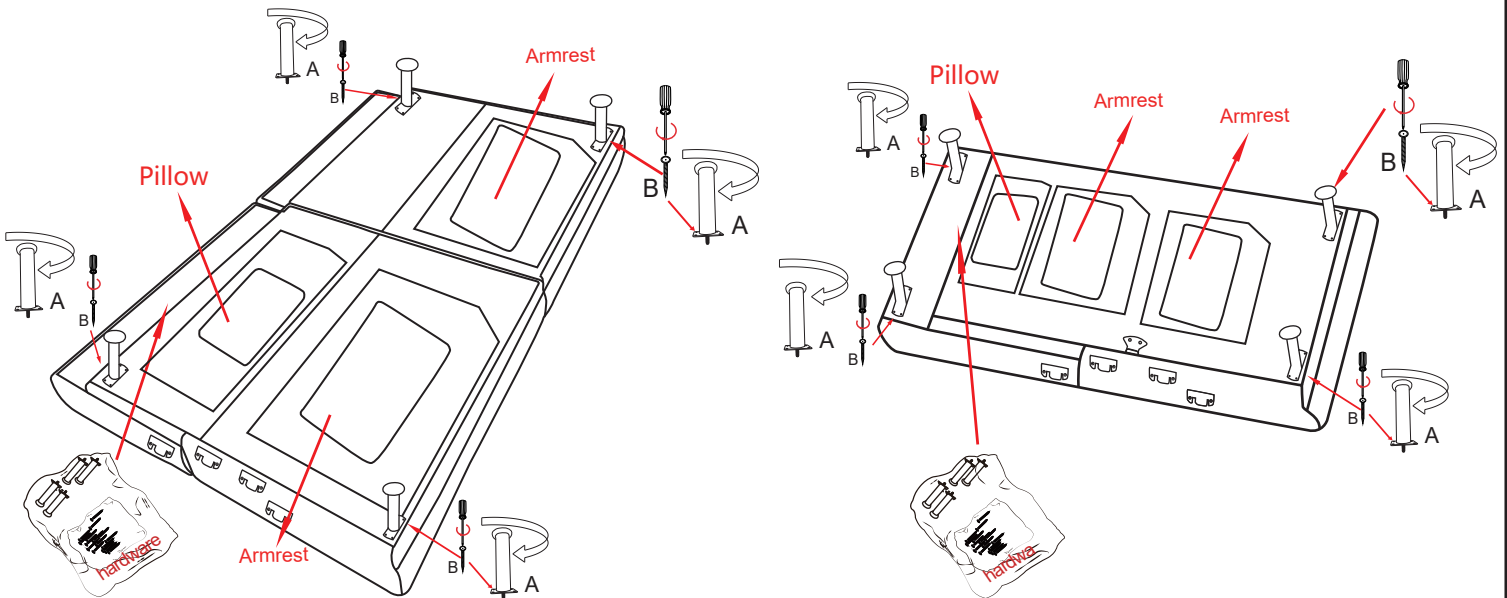

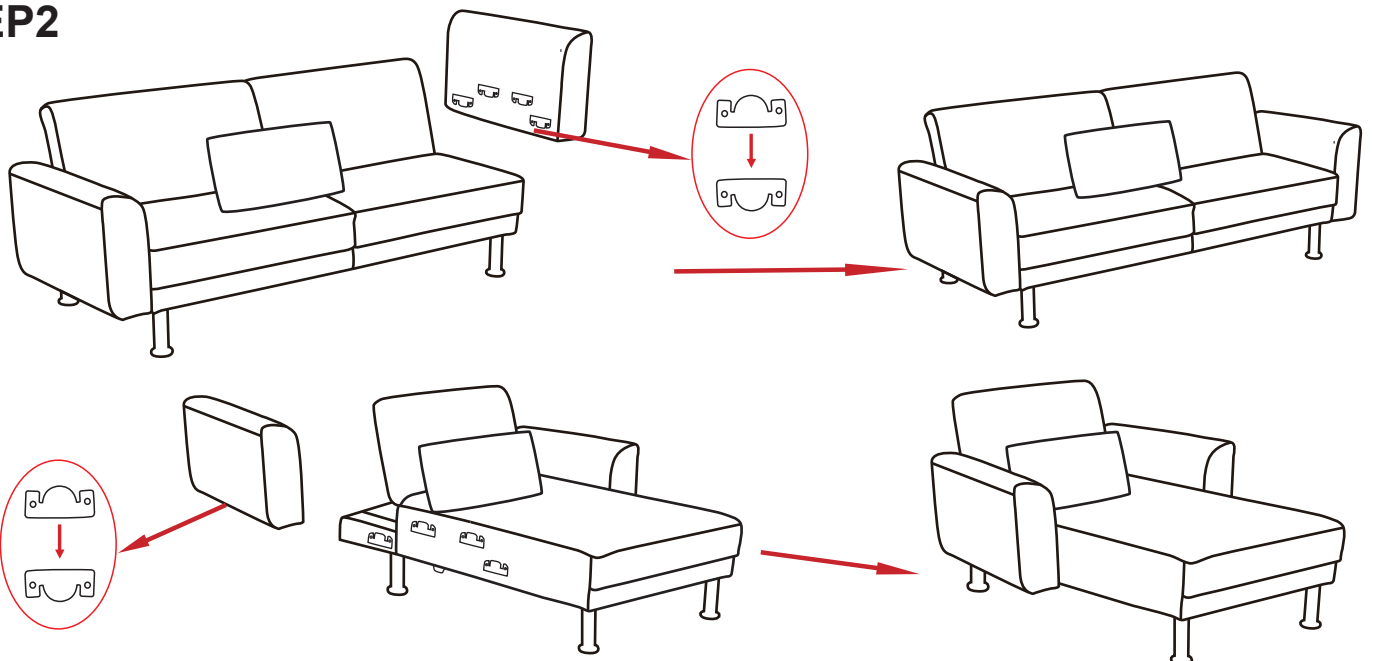

STEP2

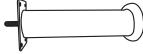

ASSEMBLY INSTRUCTION

Please follow below Assembly Procedures step by step.

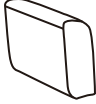
HARDWARE LIST			
NO.	DESCRIPTION		QTY (pcs)
A	 leg		8
B	 screw		32
C	 Armrest		4

STEP1

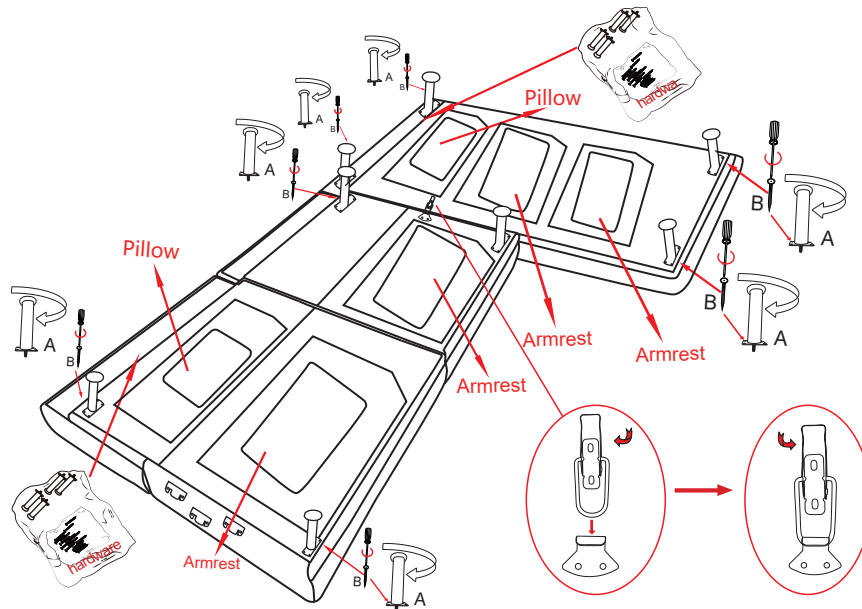

STEP2

