





Assembly Instructions

Caution: You must read this before you proceed





Dining Chair

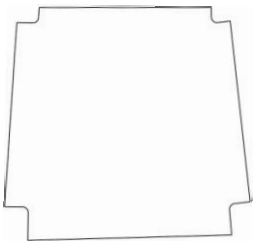

Part List

Label	Picture	Description	QTY
A		Seat with Back	1
B		Front Leg	2
C		Left Back Leg	1
D		Right Back Leg	1
E		Seat Base Cover	1

Hardware

Label	Picture	Description	QTY
①		Bolt (M8*60MM)	9
②		Spring Washer	9
③		Washer	9
④		Allen Key	1

Assembly Preparation

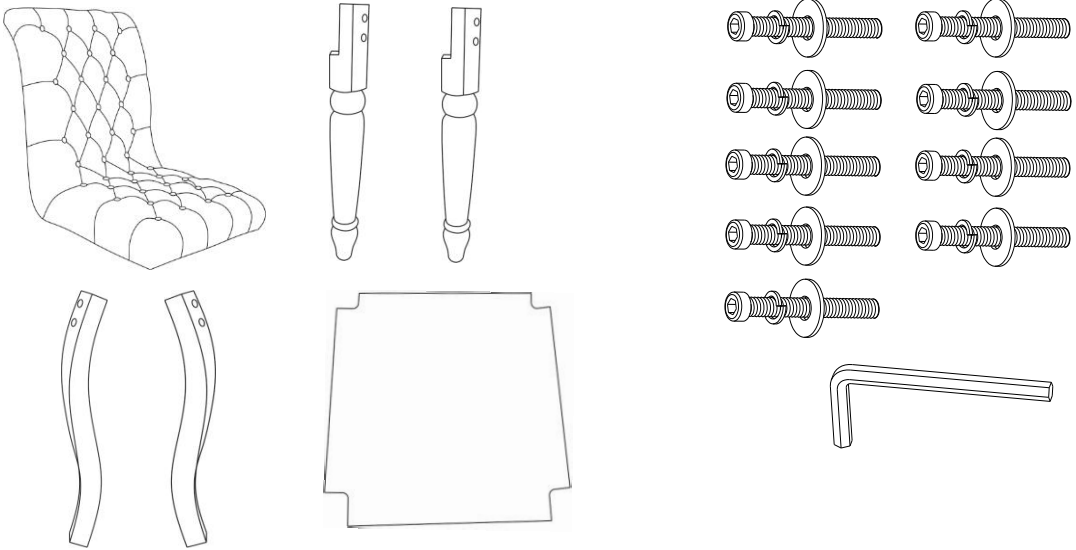
<p>Before Beginning Assembly:</p>			
-----------------------------------	--	--	--



- Read instructions, cover to cover-



- Have 2 adults on hand for assembly-



- Do not assemble on flooring or carpet-



- Assemble on a clean non-marring surface (packing foam)-



- Save all packaging until finished-

Assembly Steps

Overview

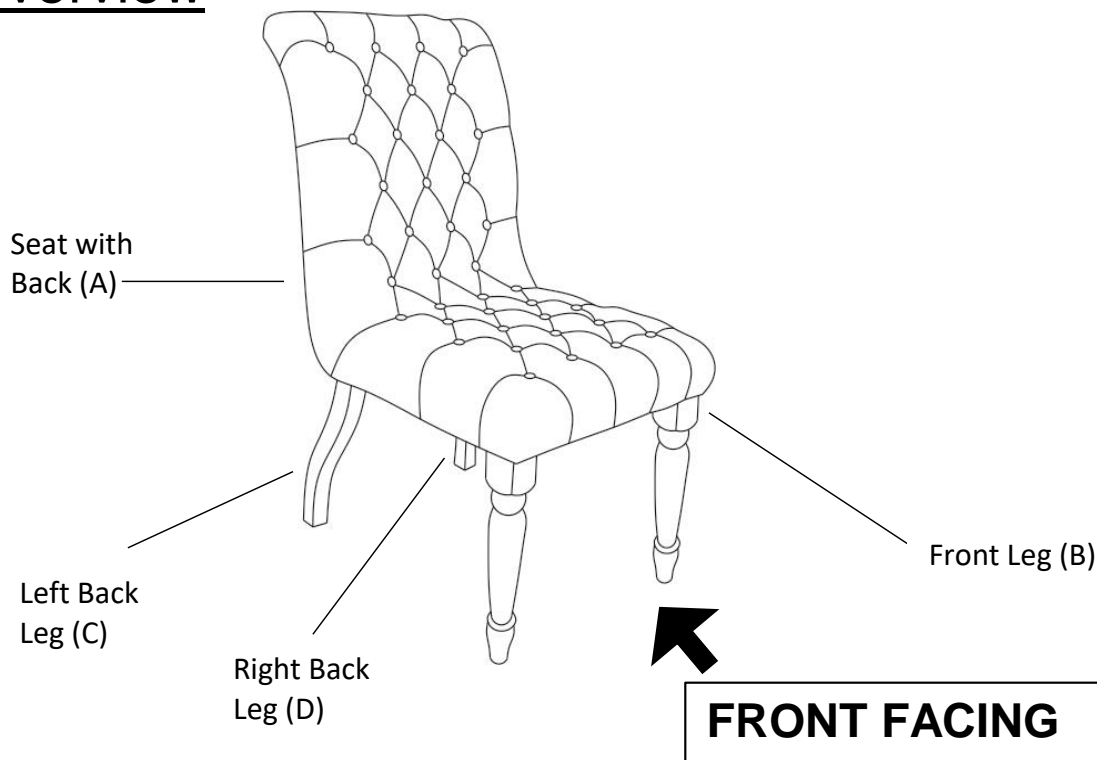

This Chair has multiple parts and may require up to 30 minutes to assemble. To give you an overview of the Chair parts, the above picture is to help you put the various parts into perspective. Please read through the instructions below to familiarise yourself with the parts and steps before assembly.

Step 1

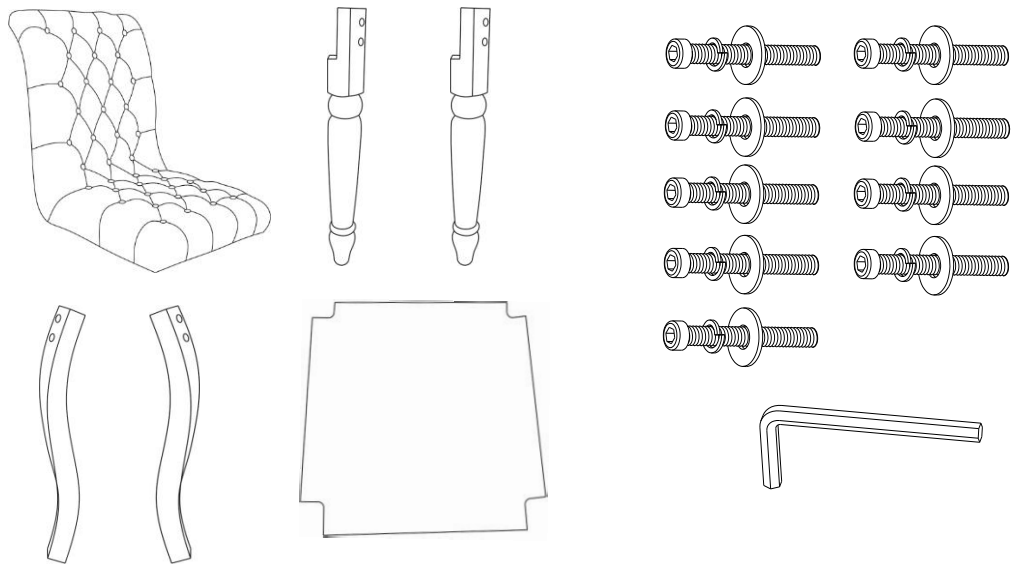

Unpack and place all parts on a clean, non-marring surface.

Step 2

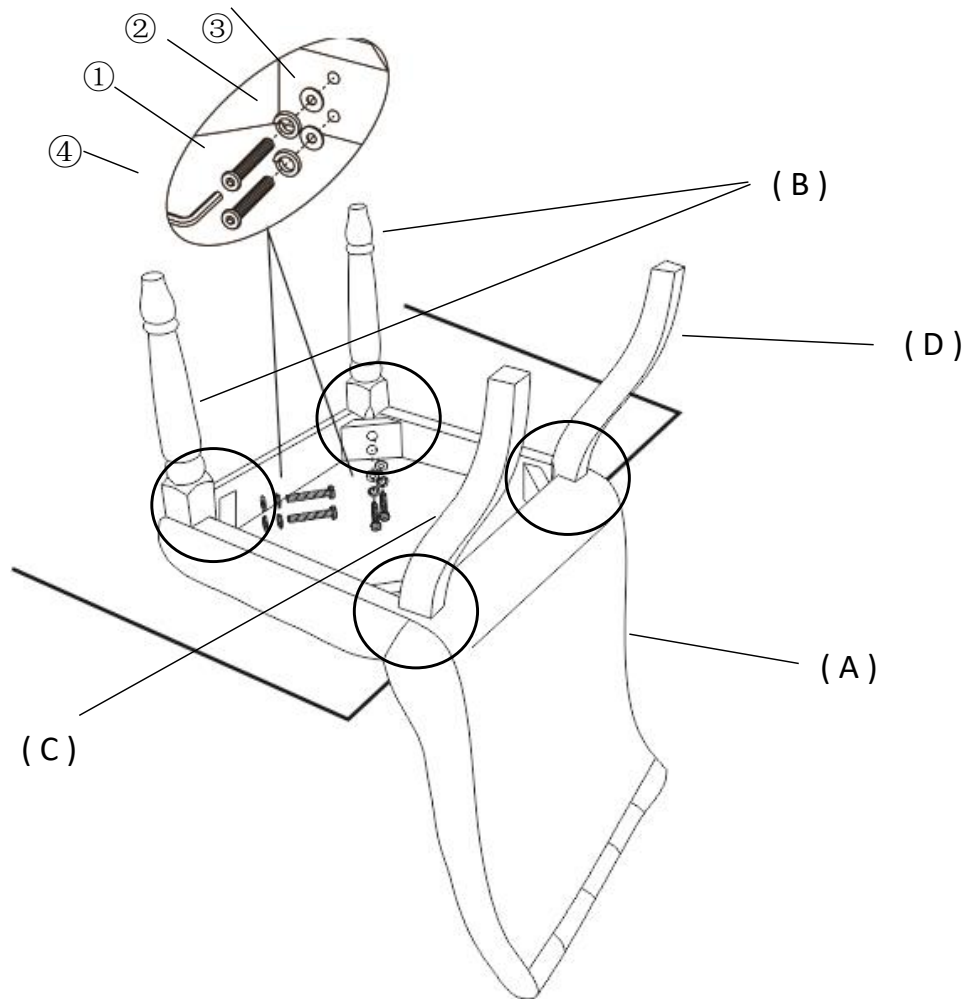

Place the Seat with Back(A) on the side of a table with the Seat facing down, as seen in the picture.

Insert Front Legs(B), Left Back Leg(C) and Right Back Leg(D) into the mounting positions of Seat with Back(A) and attach using Bolts(①), Spring Washers(②) and Washers(③) with Allen Key(④).

Do not fully tighten the Bolts.

Step 3

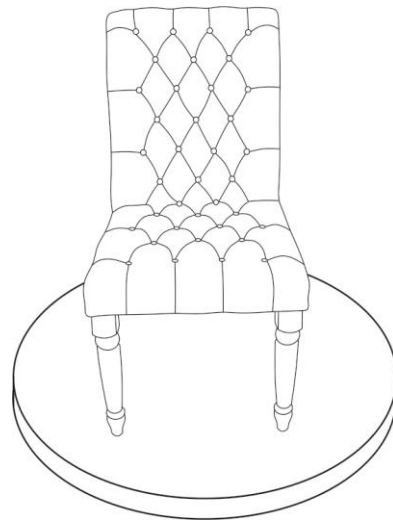

1 If wobbles

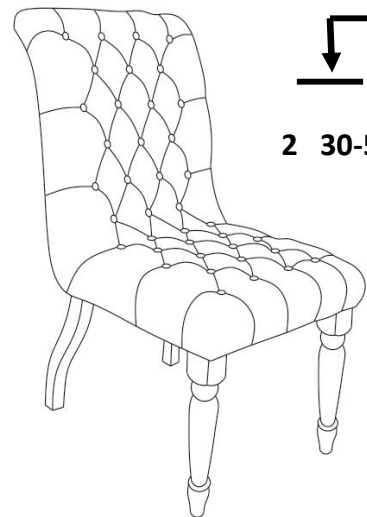

2 30-50cm



3 Test again

Place the Chair on a level Surface to check if it wobbles. If it wobbles, lift the Chair some 30cm to 50cm high from the ground.

Keep your feet and toes well away from the drop zone.

Drop chair freely and vertically, with the four legs hitting the ground at the same time.

This **Drop Test** will help to ensure that all the Bolts and gaps to all reach full alignment status.

Test again for evenness on a Level Surface.

If no wobbles are found, proceed to tighten all the Bolts.

When tightening the Bolts, tighten sequentially.

Do not fully tighten any screw fully and then towards the next one.

This may cause the frame to warp.

If there are still wobbles, loosen the Bolts and execute this same drop test.

Step 4

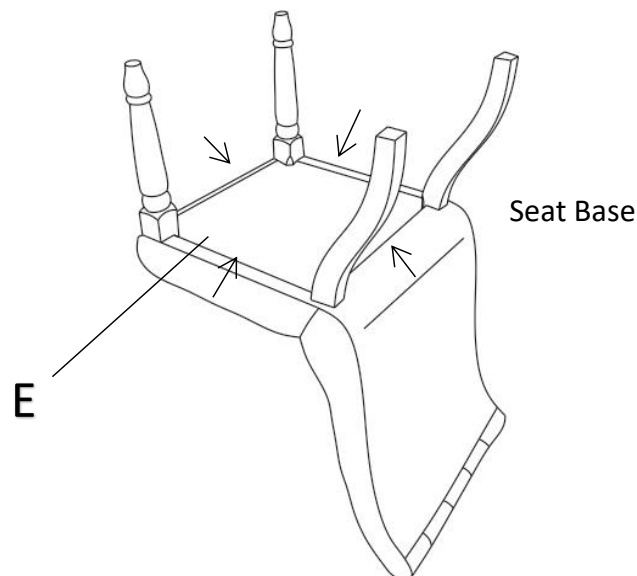

Carefully place the non-woven Seat Base Cover(E) on the Bottom of the Seat, align Seat(A) to Seat Base Cover(E) and smooth the edges with your hands.









Step 5

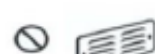

Your Dining Chair is ready for use.

This Dining Chair can only be used on a flat, level surface.

Care & Maintenance

-  Do not put hot items directly on furniture surface
 -  Do not clean furniture with harsh cleansers or polish.
 -  Do not place furniture under direct sunlight.
 -  Do not place furniture near heating or cooling vents.
 -  Do not write on furniture without a padded barrier to protect the surface.
 -  Do not place furniture outside . For indoor use only .
 -  Not for commercial use. For residential use only .
 -  Stains may be removed with mild soap solution and damp cloth.
 -  Children should not climb or jump on the furniture.
-
-  Dust and pick-up spills using a clean, non-colored, lint-free cloth .