

402 Kit Installation Guide



#142 Flat Track Series Hardware

Visit our website at www.doorhdwe.com for detailed installation instructions.

Step 7

Measure and locate hanger holes.

Important! For the door to align with the track stops, the hanger holes at center must be 4-1/2" from edge of door.

Mark the top and bottom hole positions as shown in the diagram.

Step 8

Using the Anti-Jump Block as a guide, run the screw in and out before installing the hangers.

Step 9

Attach the hanger to the door by inserting the carriage bolts from the back side. Secure with acorn nut and washer, and mount door on track.

Step 10

With the door in the open position, place the Fin Guide at the jamb opening. If positioned correctly, the Fin Guide will be concealed under the door in the open or closed position.

Step 11

Place the Anti-Jump Block underneath the hanger in alignment with the holes and screw into place. Repeat the steps for the other hanger. Test Anti-Jump by lifting the door.

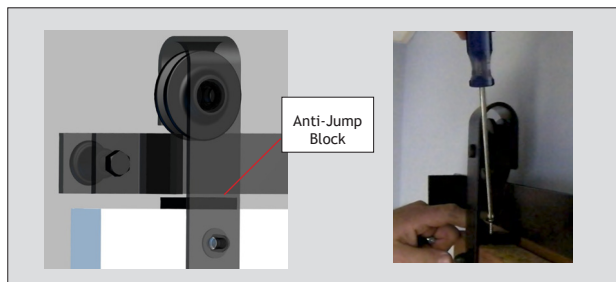
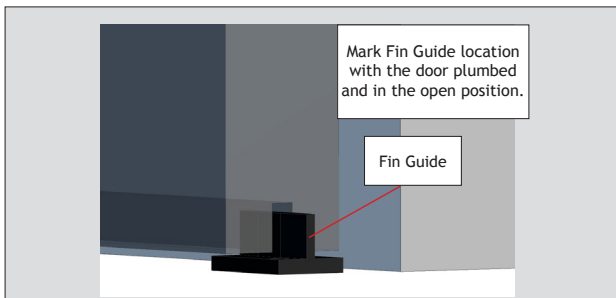
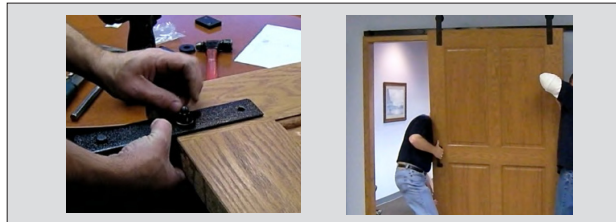
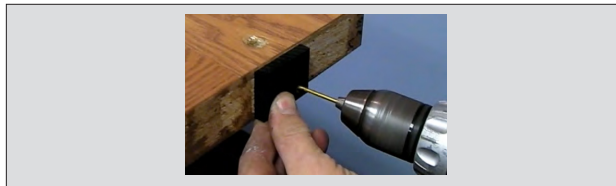
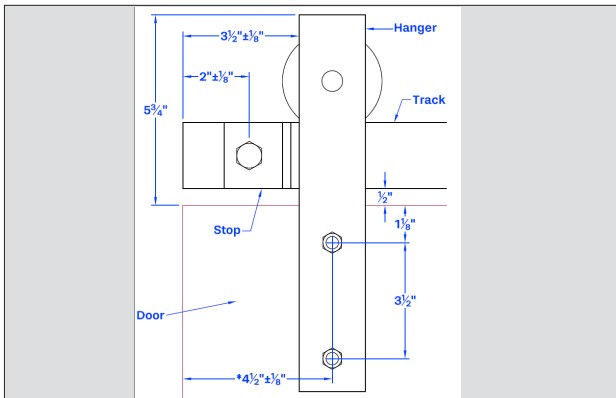

Thank you for purchasing Flat Track by Leatherneck Hardware. We hope you enjoy your sliding door hardware. If you have any questions during the installation process feel free to contact us at 888.442.4572 or refer to our Installation Guide and Video available on-line (www.doorhdwe.com).



LEATHERNECK HARDWARE®
P.O. Box 1142, Danville IL 61834
888.442.4572



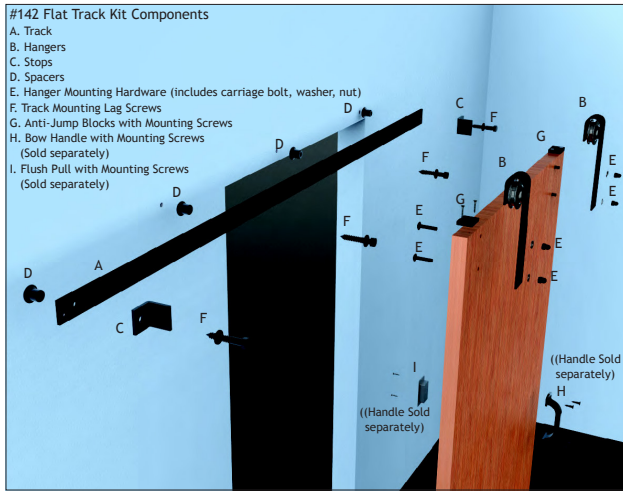

Step 1

Identify all the components of the hardware kit. Review the diagram to better visualize the install.

Note:

Your track header material will determine the appropriate fastener to use for mounting the track. The 3-1/2" lag screw fits doors up to 1-3/4" thick.

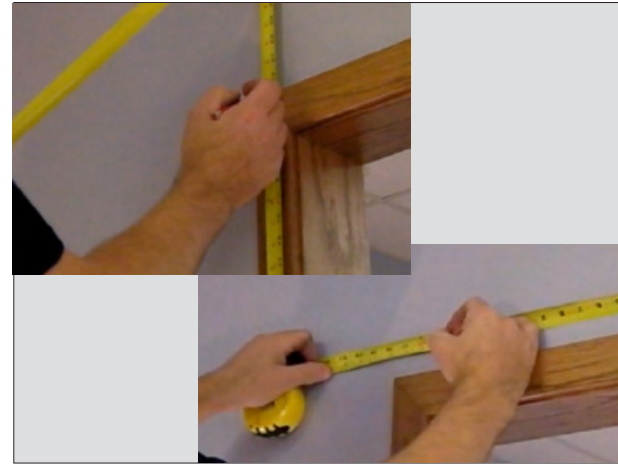

Step 4

Using the track centerline number, measure from the floor up to mark the height.

Measure horizontally from the door jamb to locate position of the 1st hole.

Level across from the 1st hole to locate the end hole. Using a 3/8" drill bit, drill the two end holes.



Step 2

The Fin Guide requires a channel at the bottom of the door to keep the door from swinging in and out. (Note: the optional Cradle Guide and Stay Roller do not require the channel).

With the door secured, used a router or saw to cut a channel that is 3/8" wide by 1/2" deep. Several passes may be necessary.

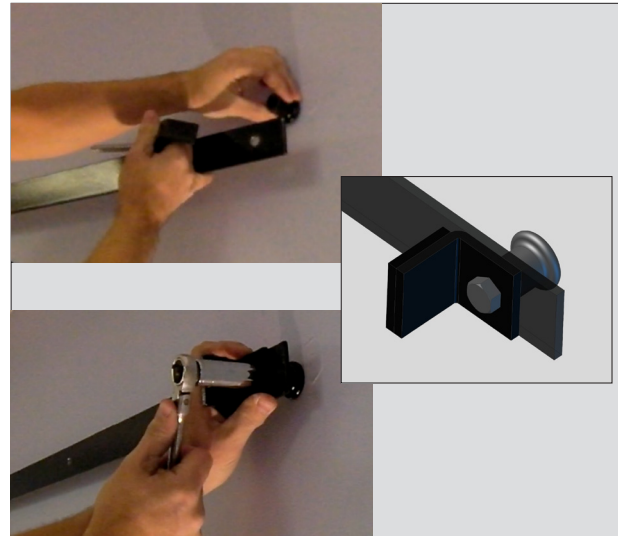

Step 5

Place the spacer between the track and the wall, and insert the lag bolt through the Door Stop (with cushion facing inward). Loosely fasten the 1st hole.

Level the track and check the previous mark at the other end. Repeat the steps for the 2nd hole installation.

Securely fasten the 1st and 2nd hole.

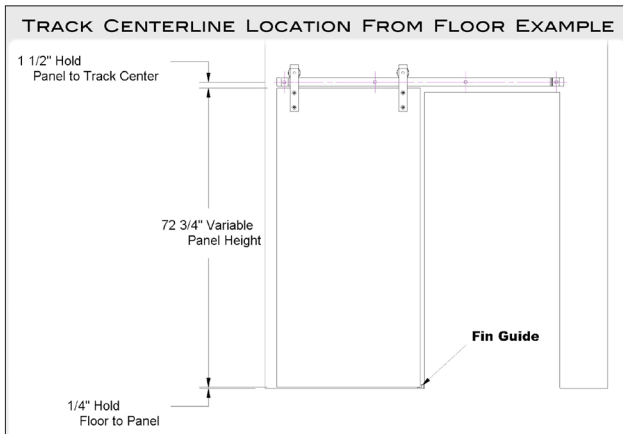

Step 3

Locate the vertical centerline of the track using this formula:

$$1-1/2'' \text{ Door to Track Ctr.} + XX'' \text{ Door Height} + 1/4'' \text{ Floor Spacing} = \text{Track Centerline From Floor}$$

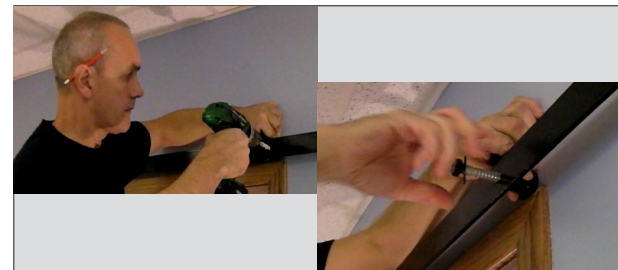

Step 6

Drill the remaining holes (using the spacer as a guide) and securely fasten with the lag bolt.



LEATHERNECK HARDWARE®
P.O. Box 1142, Danville IL 61834
888.442.4572
www.doorhdwe.com

