

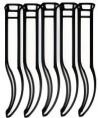











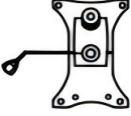

Installation & Assembly

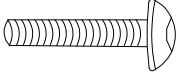
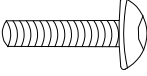
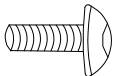

ASSEMBLY INSTRUCTION

A*5 wheel 	B*5 unpack 	C*1 pneumatic cylinder 	L1*1 left handrail 	R1*1 right handrail 
E*1 tray 	F*1 the ball of the foot 	G*1 backrest 	H*1 cushion 	
I*4 screw  M6*30	J*6 screw  M6*25	K*4 screw  M6*20	L*10 screw  M6*16	
N*6 lid 	O*1 wrench 	P*4 gasket 	Q*1 headrest 	

◆ Step 1

- ◆ Install the foot-removing screws (M6*16) properly

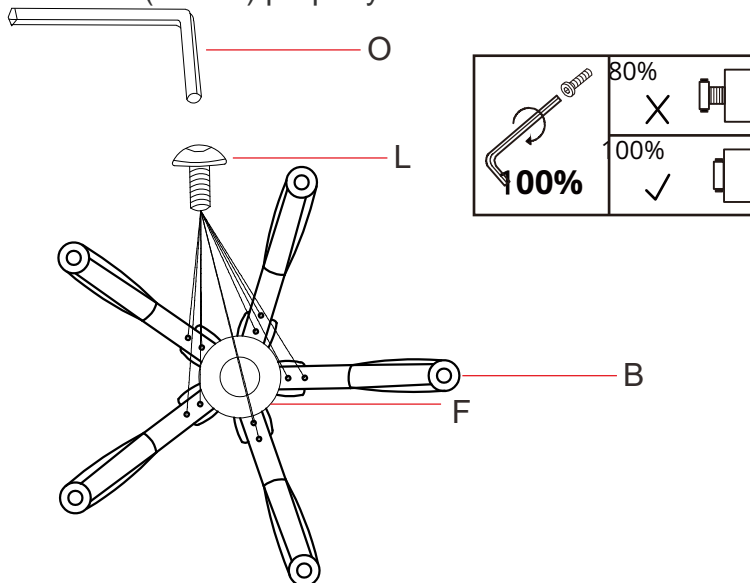

◆ Step 2

- ◆ Insert the wheel into the foot hole, and put the air rod into the center hole

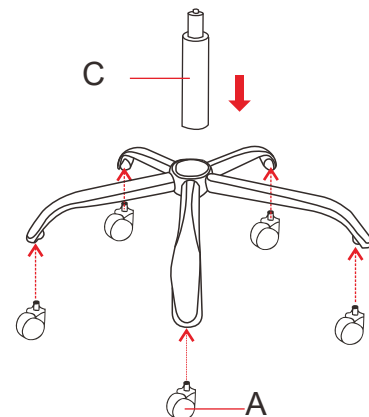

◆ Step 3

- ◆ Install the backrest with 6*25 screws on the handrail

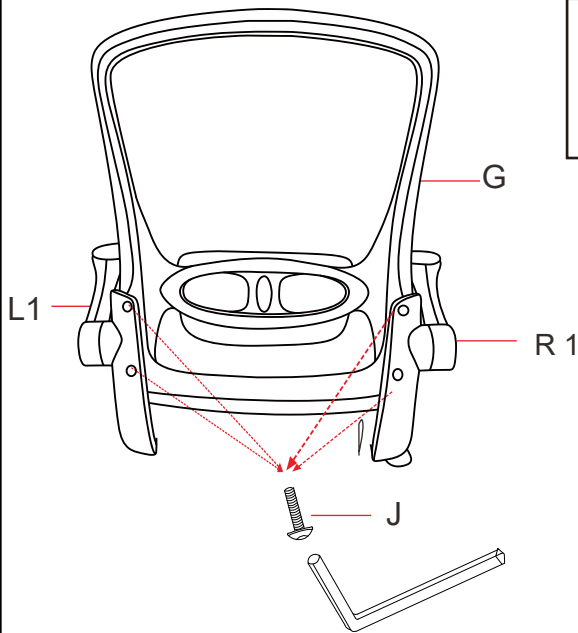

◆ Step 4

- ◆ Install the tray with screws (M6*20), Then install the screws at the bottom of the handrail with (6*30), and the handrail screws need to add washers.

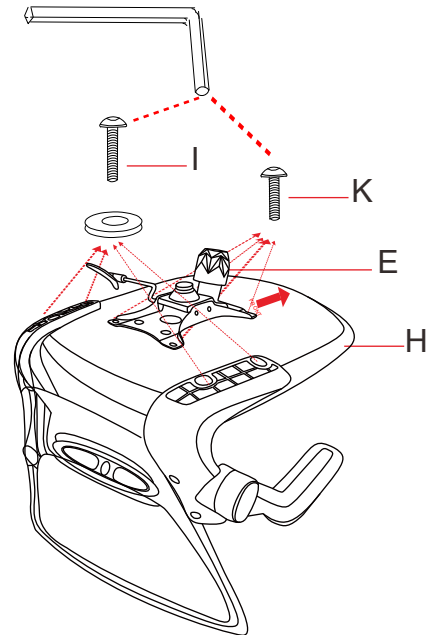
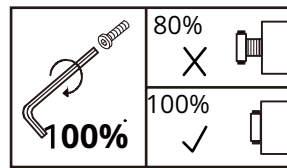

◆ Step 5

- ◆ Place the assembled cushion on the assembled gas rod, note: the gas rod needs to be aligned with the tray hole

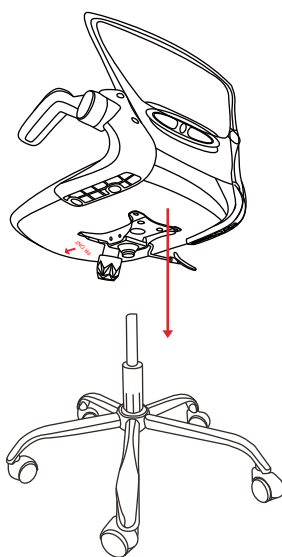

◆ Step 6

- ◆ Install the headrest with M6*25 screws on the backrest, and then press the trim cap onto the backrest and the headrest screw area

