

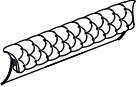



ASSEMBLY INSTRUCTION

NO	PARTLIST	QTY
1	 BACK REST 1PC	1PC
2	 SIDE PANEL (L) 1PC	1PC
3	 SIDE PANEL (R) 1PC	1PC
4	 BOX SEAT 1PC	1PC
5	 LEG 4PCS	4PCS

STEP 1

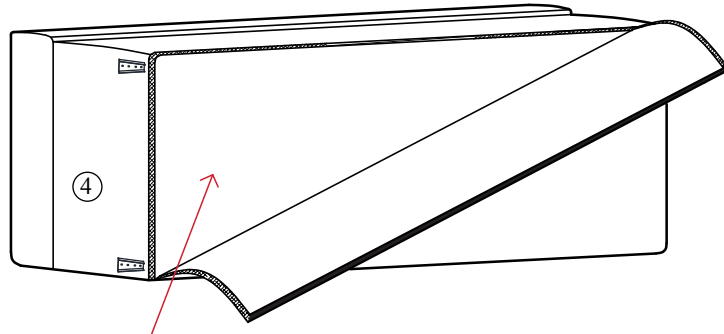

Get all others parts from compartment of seat body.

STEP 3

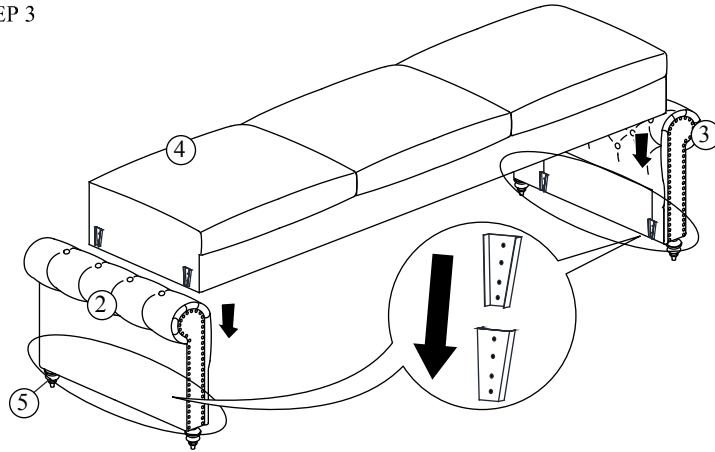

STEP 2

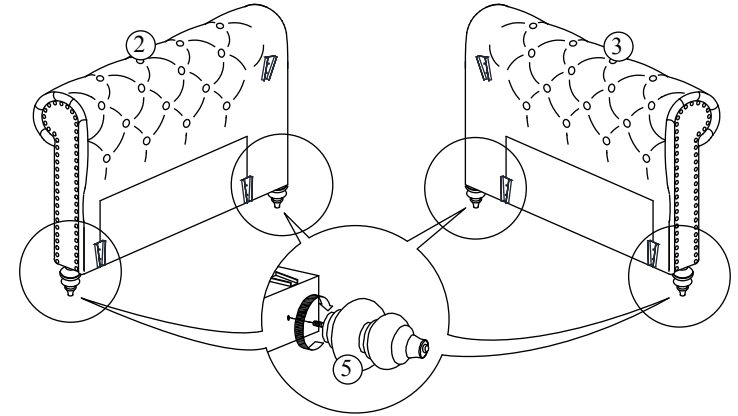

STEP 4

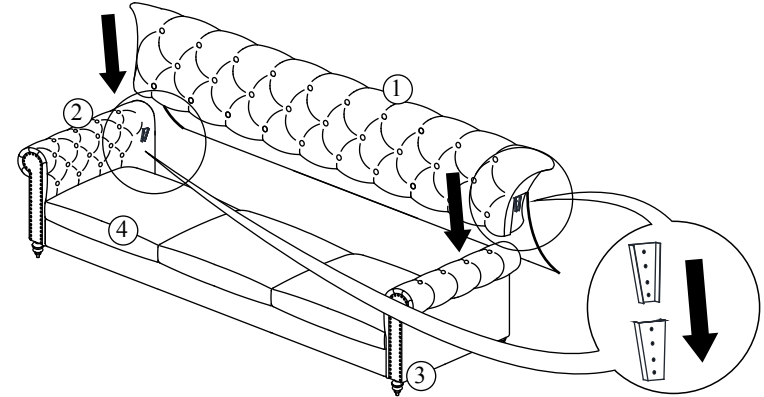

STEP 5

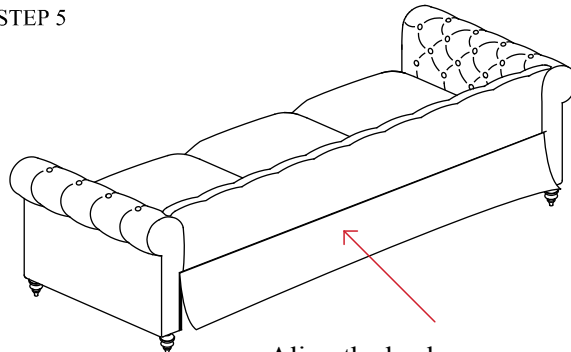

Align the back cover evenly and attached to touch fastener on frame. Repeat the step if necessary for better fit.

STEP 6

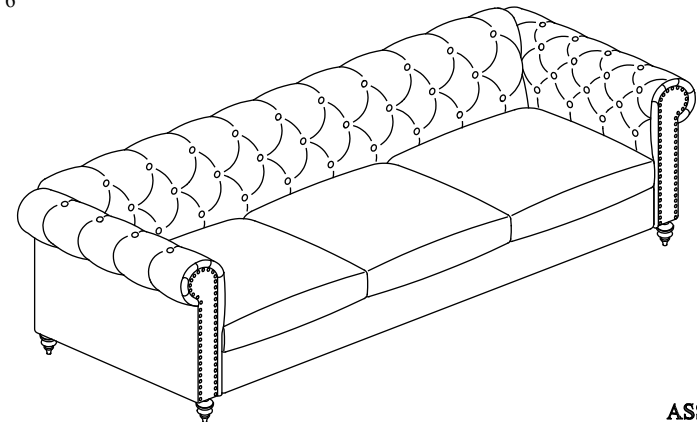

ASSEMBLY COMPLETED