

ASSEMBLY INSTRUCTIONSS S16555

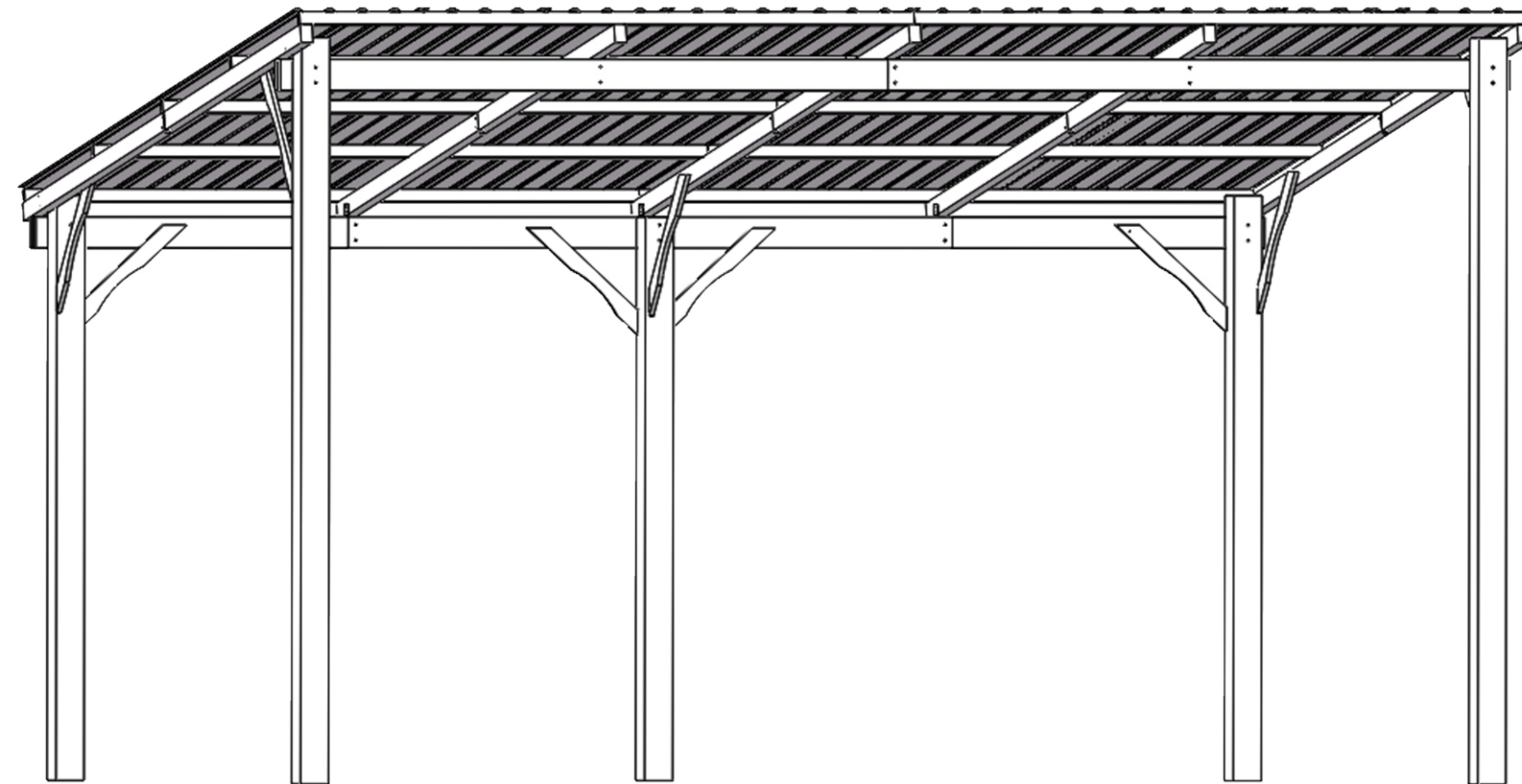

IMPORTANT !

READ INSTRUCTIONS THOROUGHLY PRIOR TO BEGINNING ASSEMBLY.

● SURFACE PREPARATION

To ensure proper assembly you must build your carport on a level surface.

● CHECK ALL PARTS

Inventory all parts listed on Part Identification page inside this manual.
Contact our Customer Service Team if any parts are missing or damaged.

● ADDITIONAL TOOL

You will need additional tools to complete your wood carport.
See inside this manual for recommended and optional materials and quantities.

IMPORTANT SAFETY INFORMATION



IT IS VERY IMPORTANT TO READ AND FOLLOW THE SAFETY PRECAUTIONS BEFORE ASSEMBLY AND DURING THE USE OF THE PRODUCT.

1. The outdoor carport is designed primarily to extend the outdoor use of your home.

DO NOT USE STRUCTURE AS FOLLOW:

- As safety barrier to prevent unsupervised access to pools, hot tubs, spas or ponds.
- As load bearing support for other structures, buildings or heavy objects.

If you wish to suspend products to the structure, ensure that the total weight of articles does not exceed 2500 pounds.

2. Wood is not flame retardant and has the potential of burning. Do not place any type of heat source on/under the structure or within 5 ft of the unit including, but not limited to, a barbecue, chiminea or fire pits. Consult the user's manual of these items for safe distances from combustible materials.

3. This structure is a four-season product.

4. Always install the product on a solid level surface or platform. There is no fixed device offered between bases with ground, and you can fix it by your own ways.

5. Keep all children and pets away from assembly area.

6. Do not assemble the product in days of wind or rain.

7. Wear gloves to avoid injury from possible sharp edges of individual elements before assembly.

8. During installation, follow all safety warnings provided with your tools and use safety glasses.

9. 2-4 people is recommended to install safely.

10. To avoid damages to the product its parts and surroundings, use the proper tools. The use of a ladder(s) is recommended.













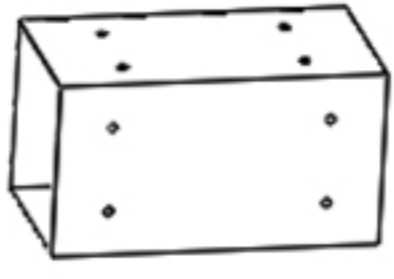

GENERAL INFORMATION

Applied water-based stain. As your carport acclimates to its new environment, natural characteristics of the wood can show in the form of checks (cracks) and weathering in the lumber. This is normal and it will not affect the structural integrity of your structure and is not covered under warranty.



Annual application of water-based water-repellent sealant or stain is important and will help reduce weathering and checks.

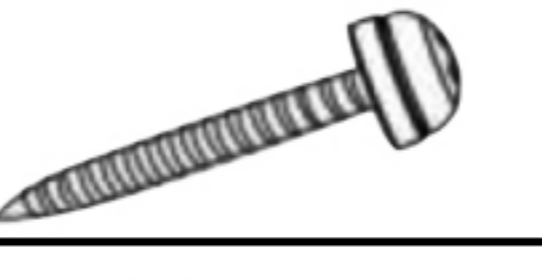
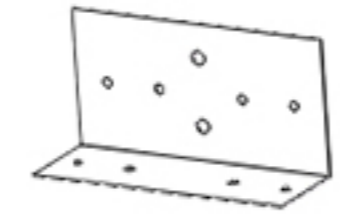

Parts List

BOX A





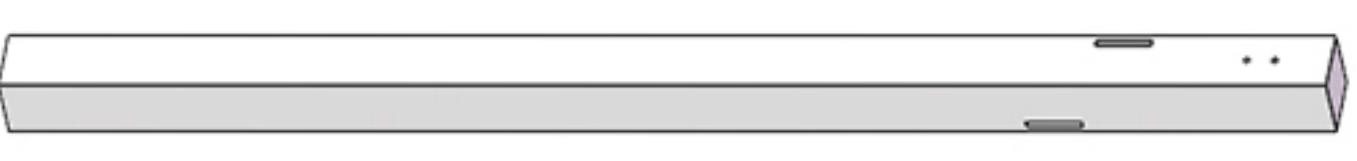

STAMP ID	QTY REQ	DESCRIPTION	IMAGE
D1	4		
D2	6		
F	2		
B	4		
L	2		
1	17	M4*70	
2	10	M10*170	
3	10	M6*50	
4	10	M6*70	
5	20		
6	20		
7	6		
8	120	M4*40	
9	72	M4*35	
10	185	M4*35	
12	5		

BOX B

STAMP ID	QTY REQ	DESCRIPTION	IMAGE
F1	1		
F2	1		

J	1		
G	1		
H	1		

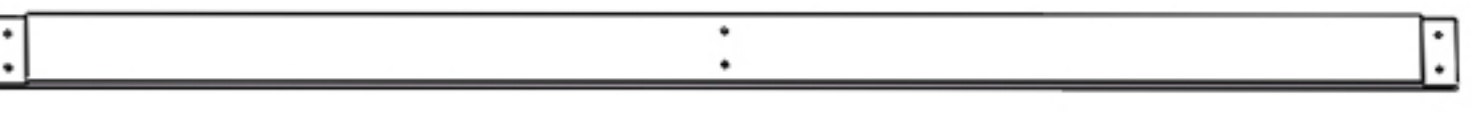
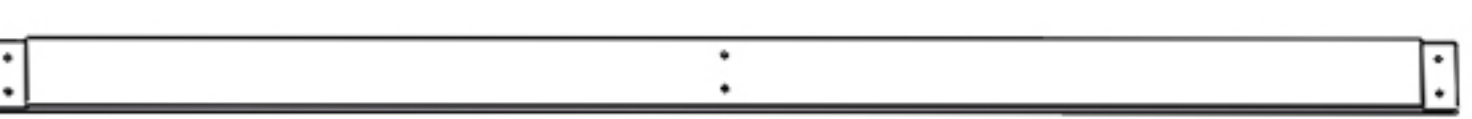
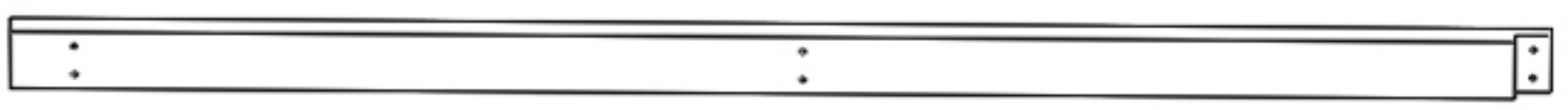
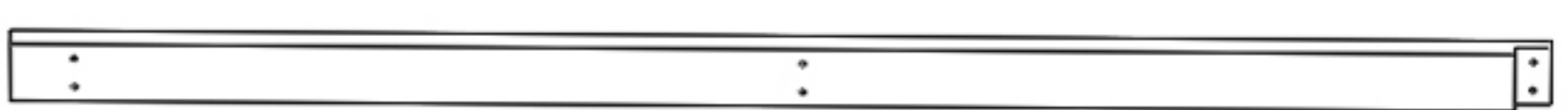
BOX C







STAMP ID	QTY REQ	DESCRIPTION	IMAGE
K4	3		
K3	2		
K1	2		
K2	2		
C1	1		
C2	1		
E	10		
A1	2		
A2	2		

BOX D

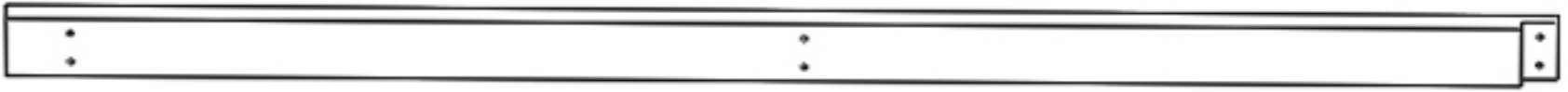
STAMP ID	QTY REQ	DESCRIPTION	IMAGE
M	18		

ASSEMBLY INSTRUCTION

STEP 1: LONG BEAM ASSEMBLY

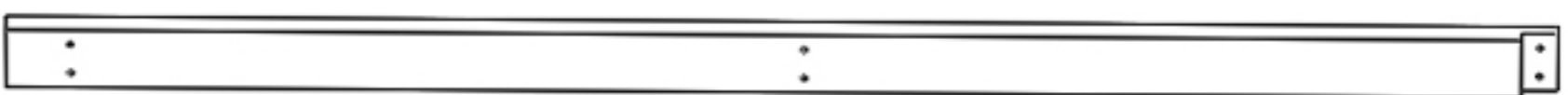
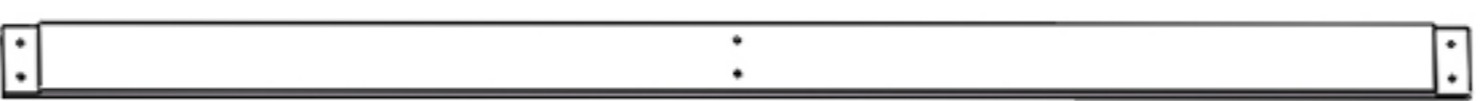
STAMP ID	QTY REQ	BOX	IMAGE
A1	2	C	
B	4	A	
C1	1	C	
4	10	A	 M6*70
5	10	A	
6	10	A	
A2	2	C	
C2	1	C	



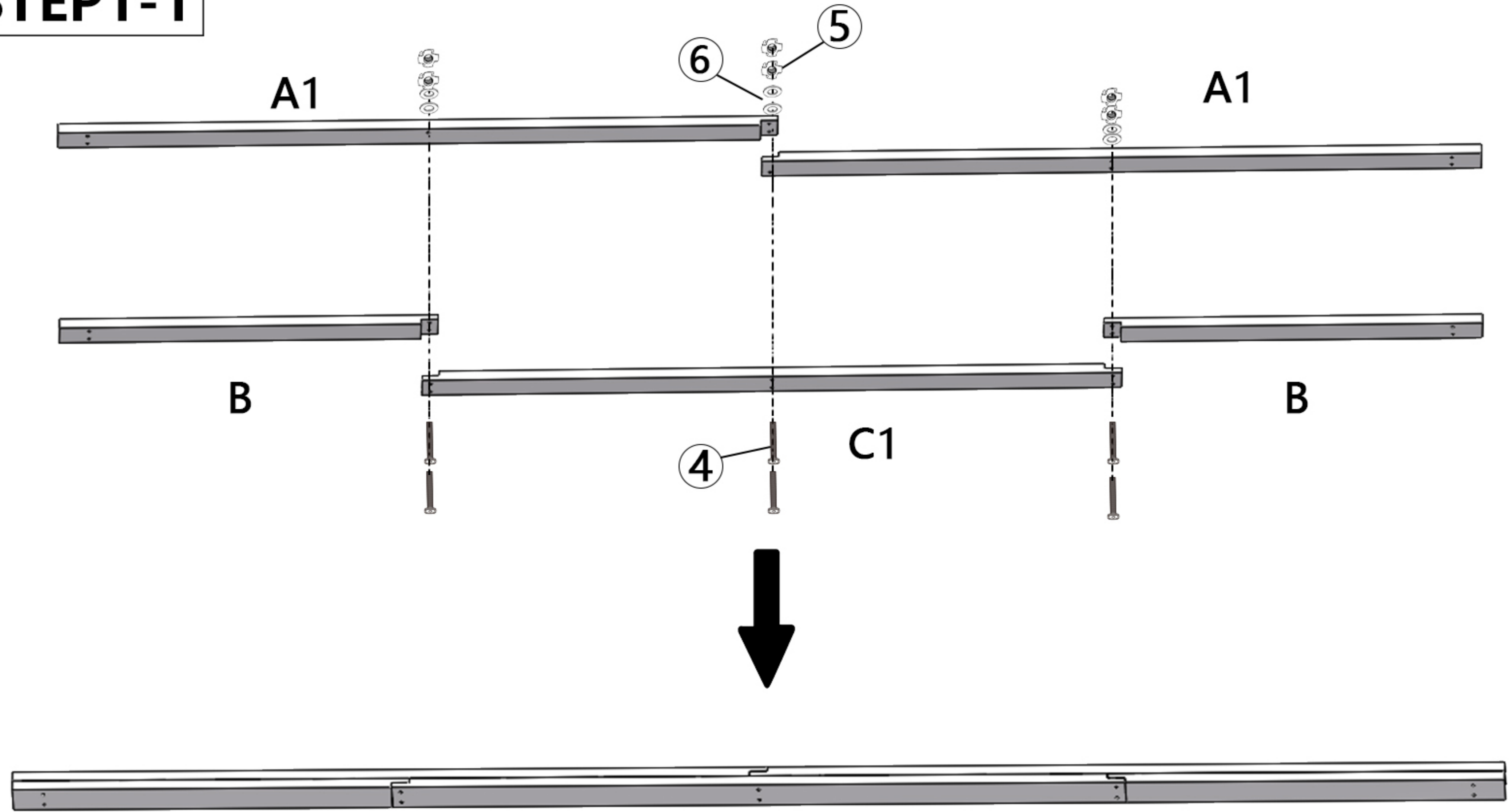

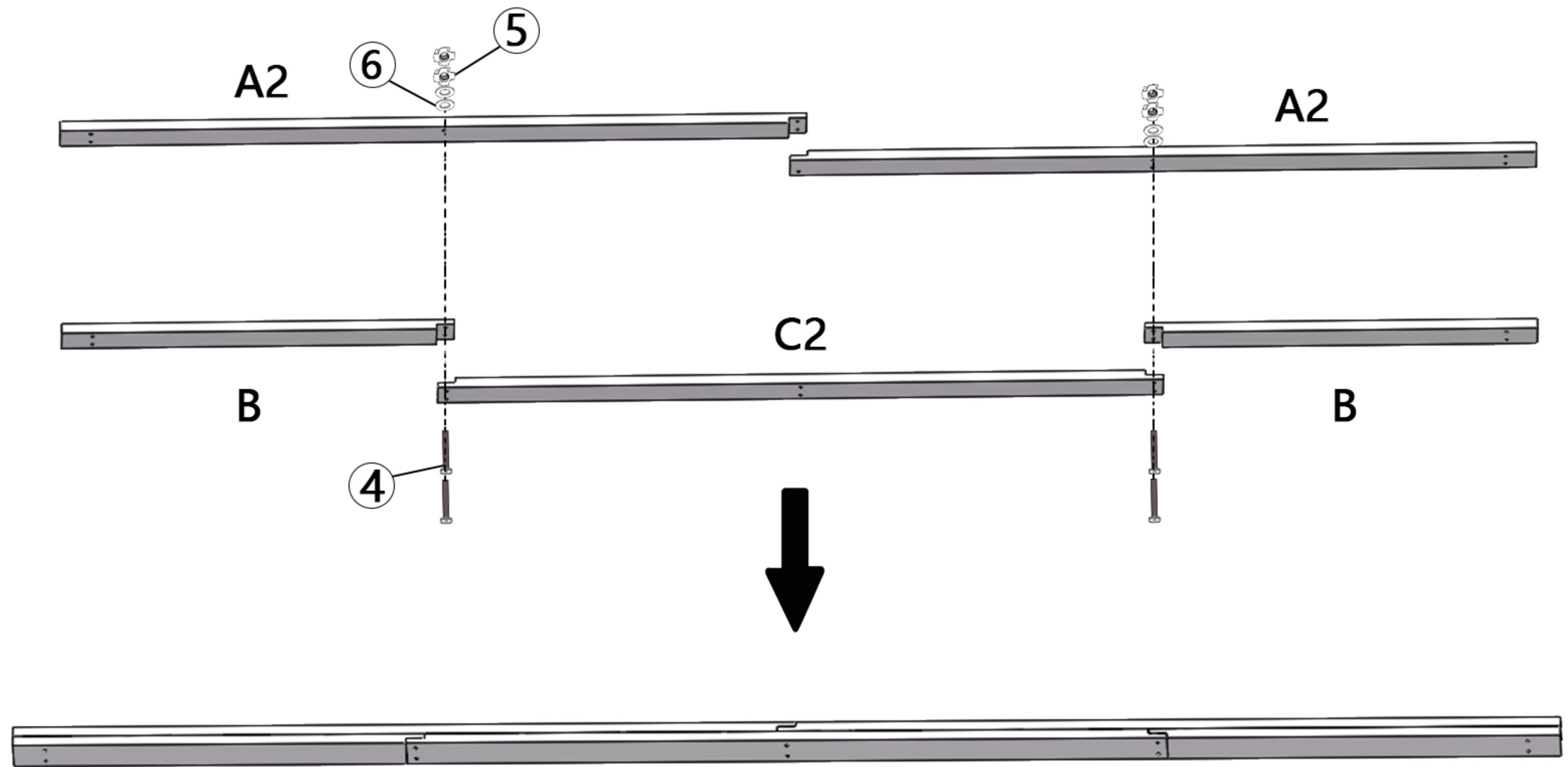

STEP1-1



STEP1-2

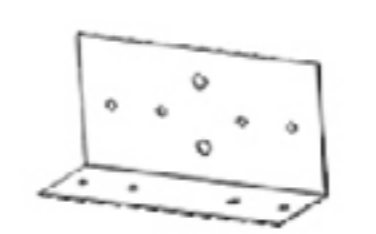





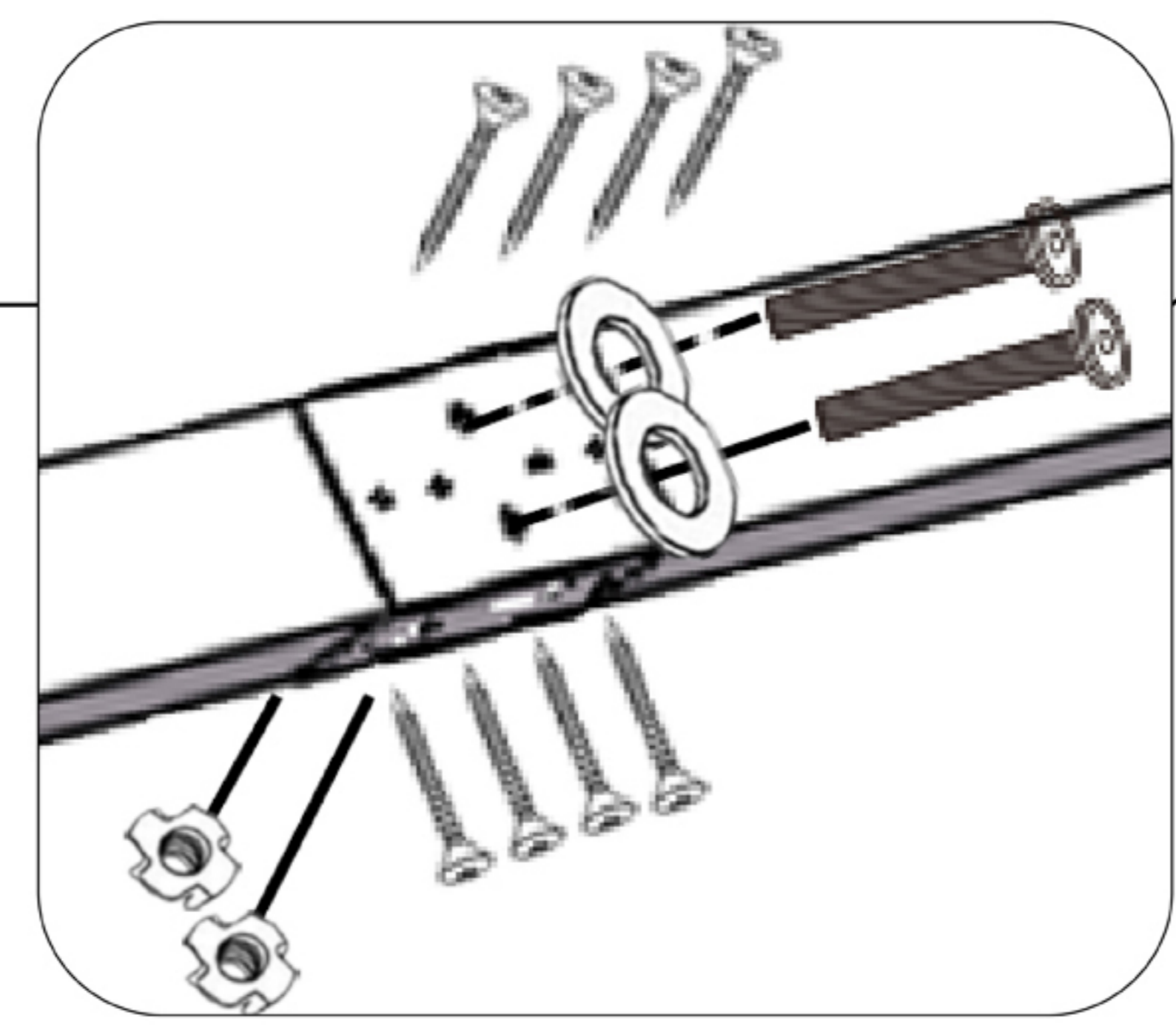
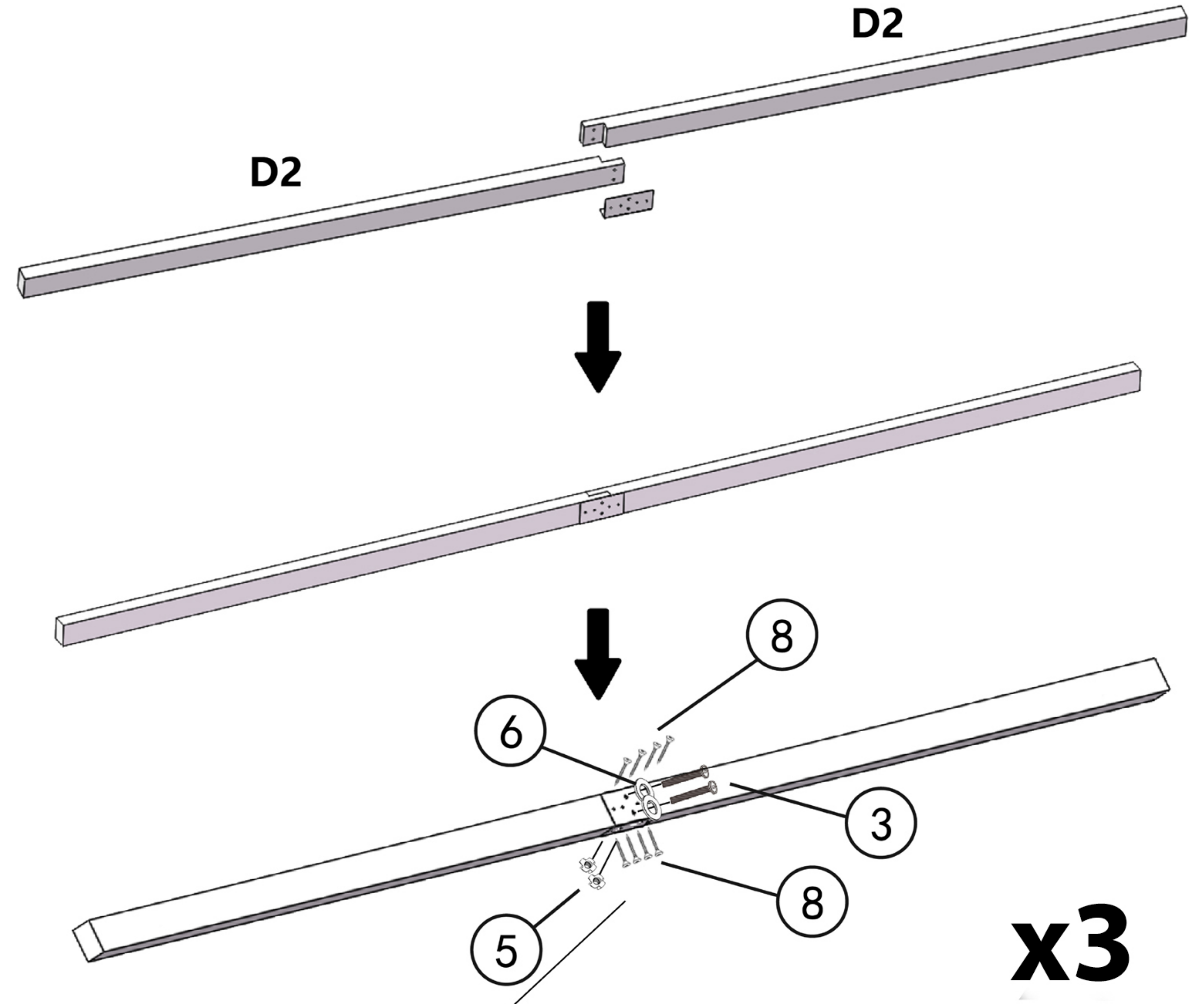
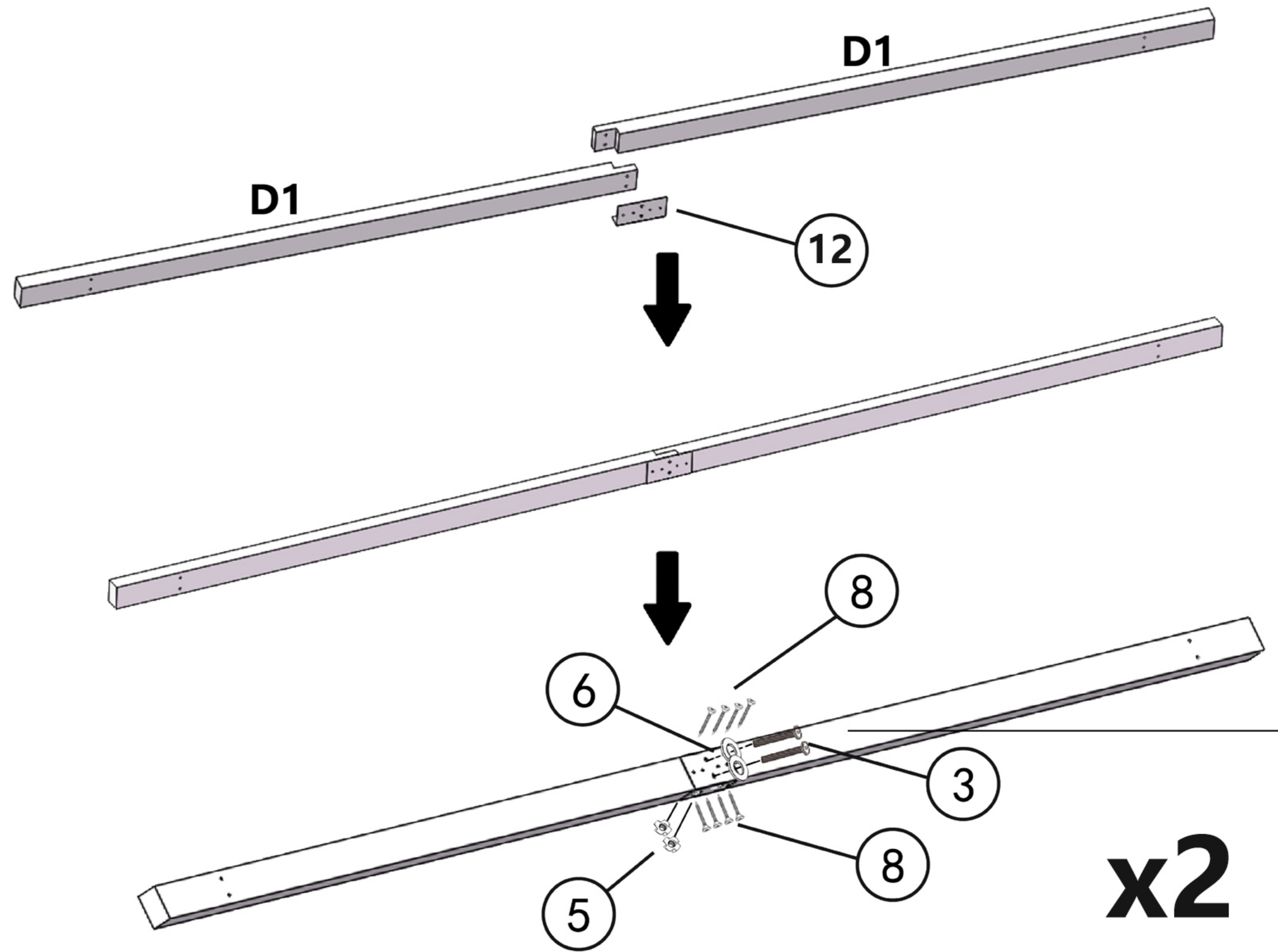

STEP:2

STAMP ID	QTY REQ	BOX	IMAGE
D1	4	A	
D2	6	A	
8	40	A	 M4*40
12	5	A	
3	10	A	 M6*50
5	10	A	
6	10	A	

STEP2-1

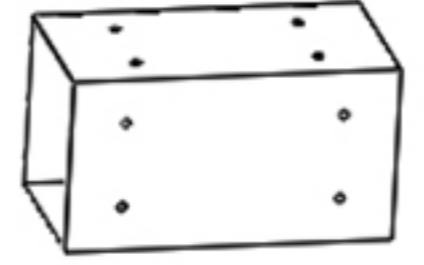

STEP:3

STAMP ID	QTY REQ	BOX	IMAGE
2	10	A	
F1	1	B	
F2	1	B	
A1	1	C	
A2	1	C	
F	2	A	
8	32	A	
L	2	A	

STEP3-1

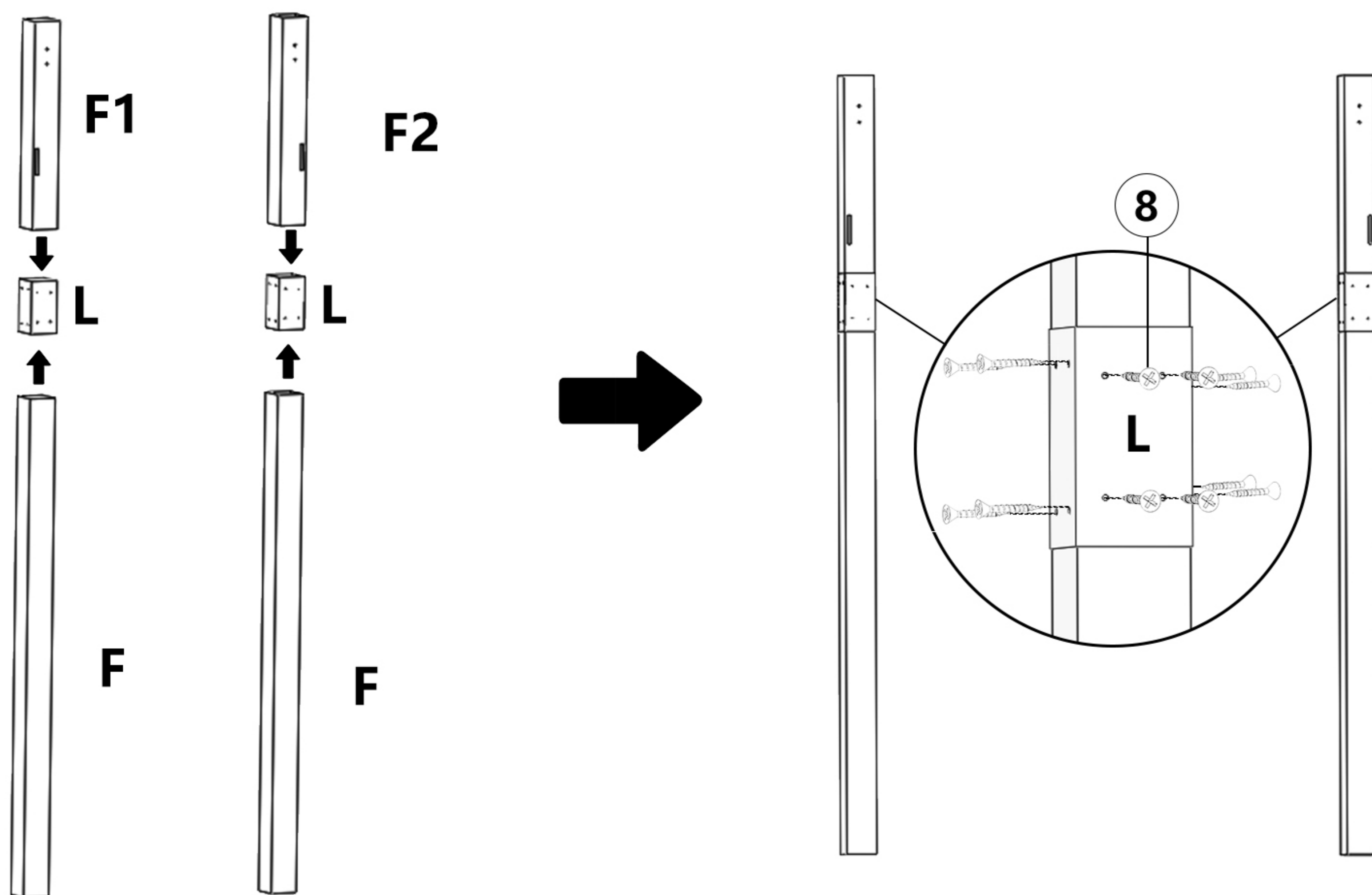



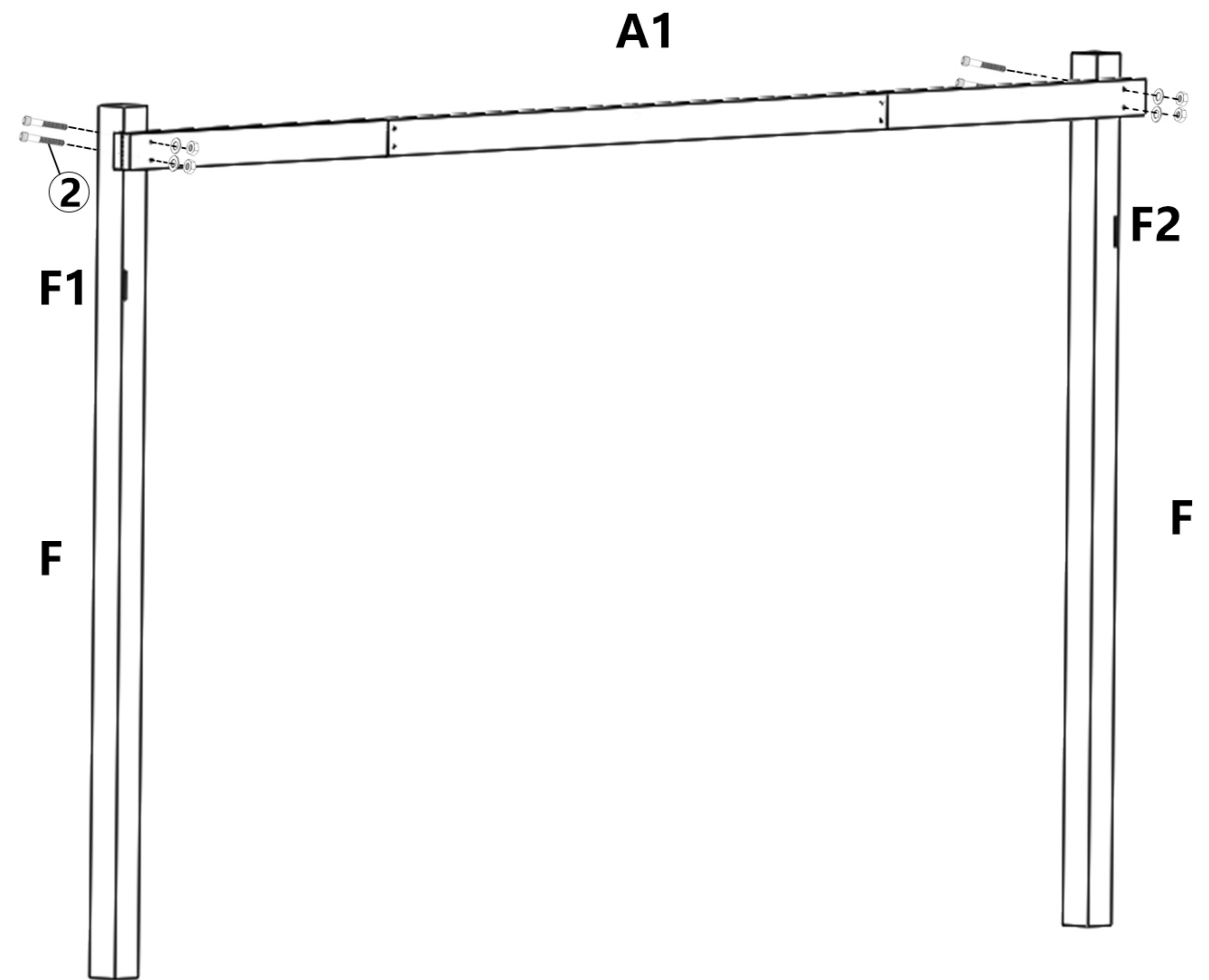

STEP3-2

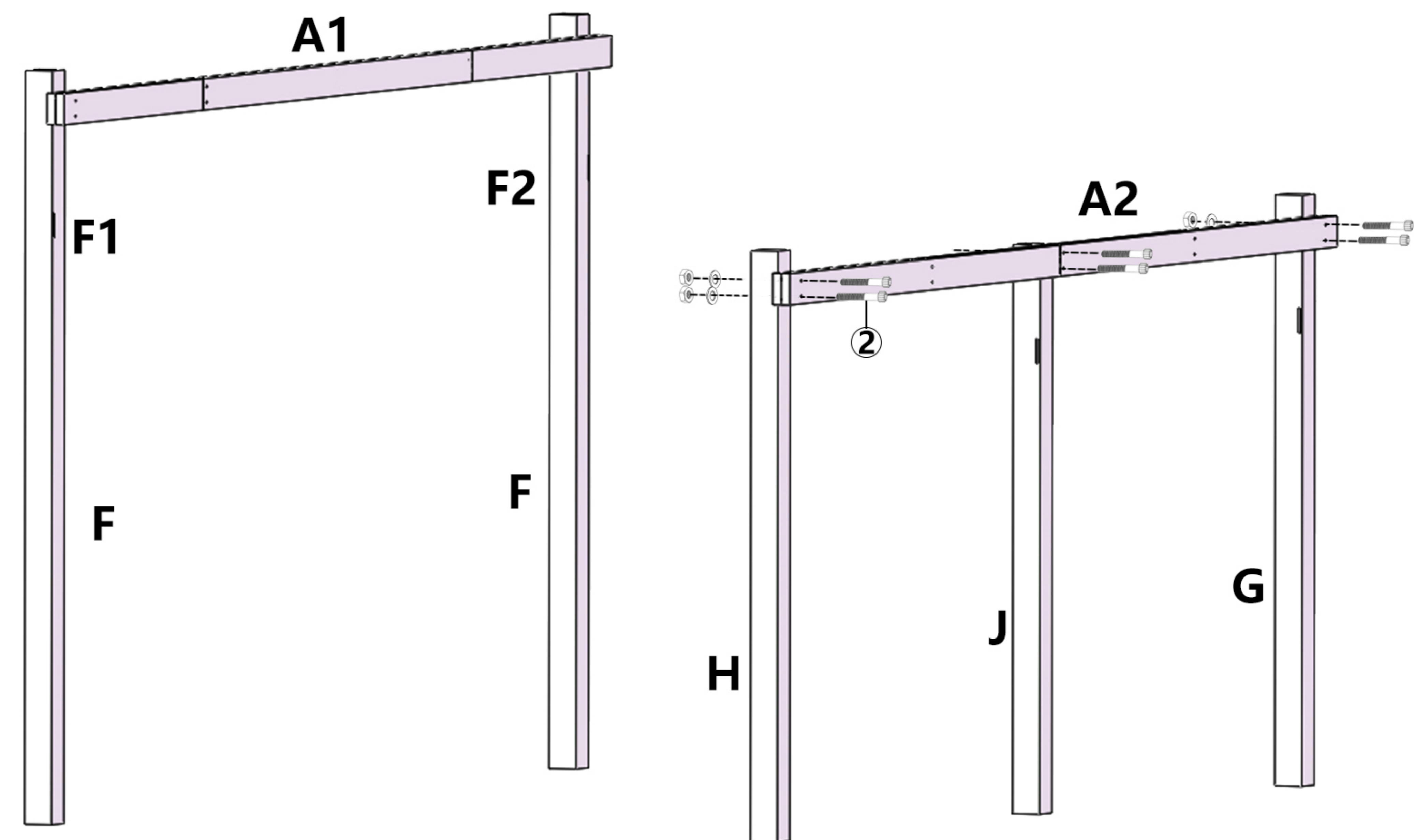

STEP3-3

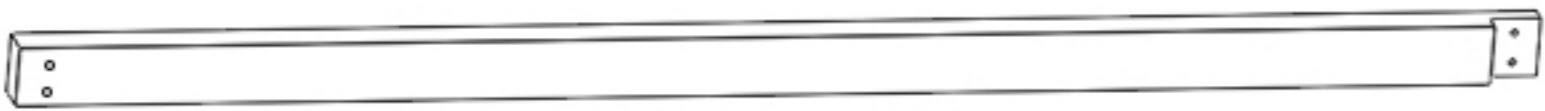

STEP:4

STAMP ID	QTY REQ	BOX	IMAGE
D1	2	A	
1	8	A	 M4*70
D2	3	A	
7	6	A	
9	36	A	 M4*35



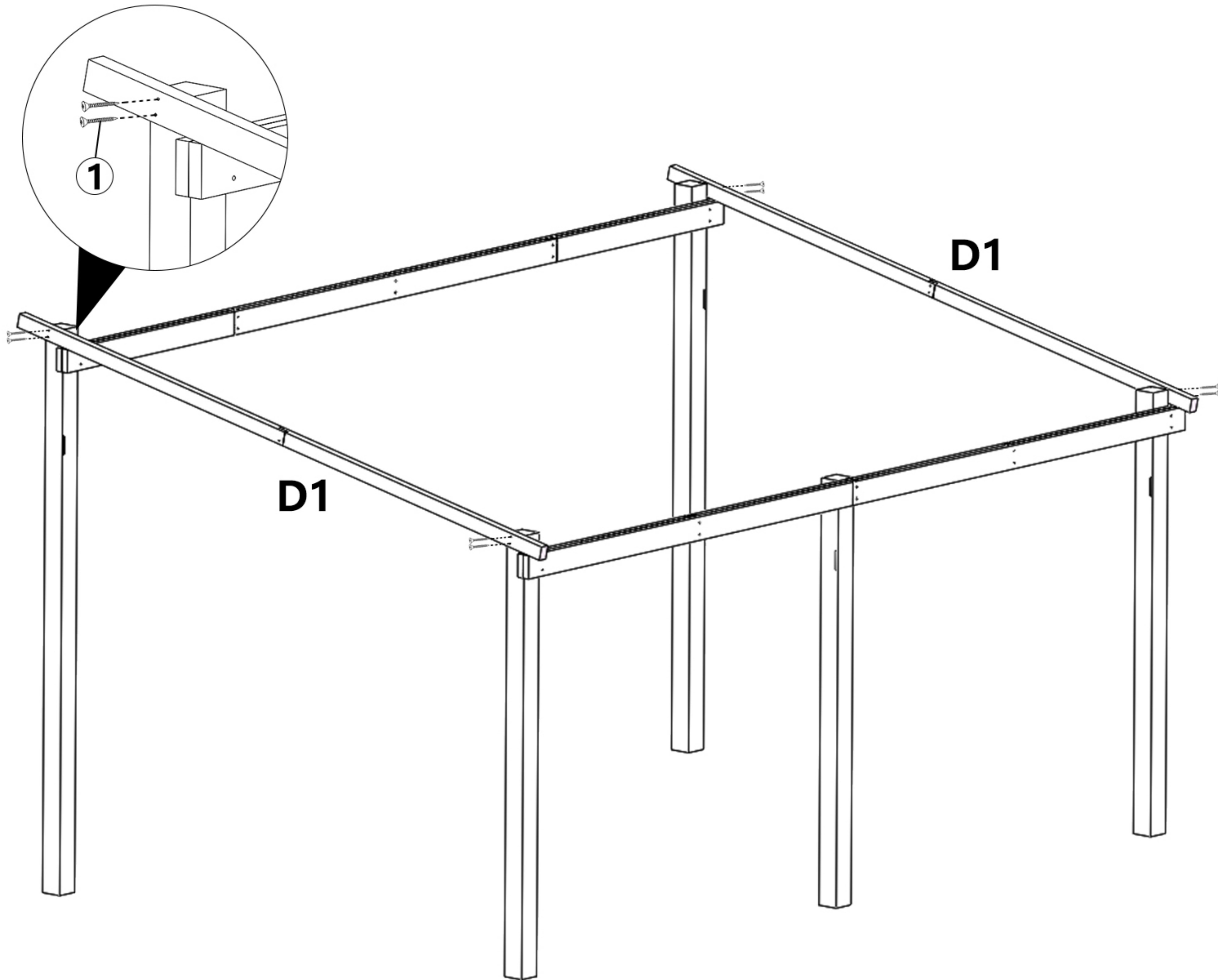

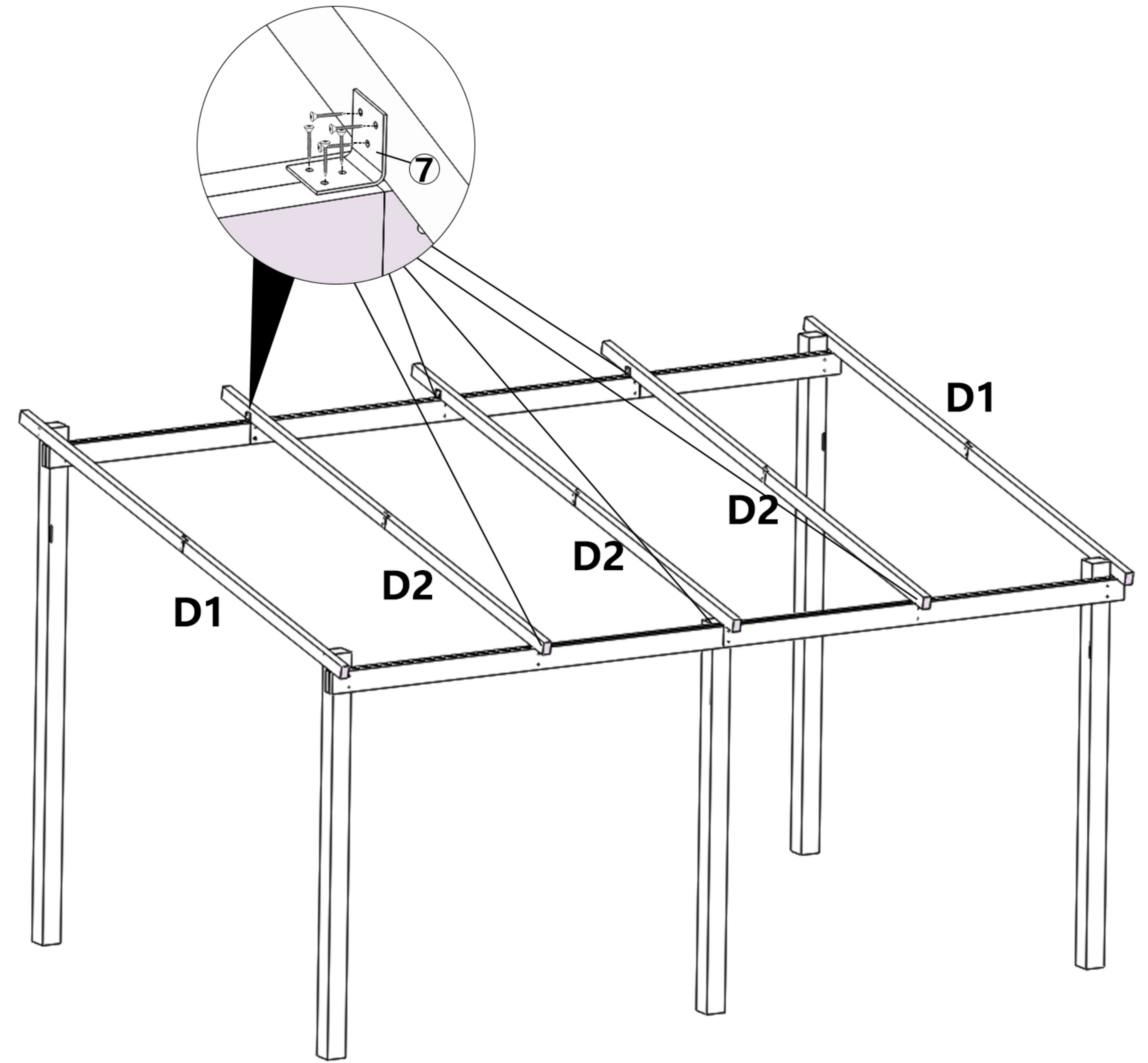

STEP4-1



STEP4-2

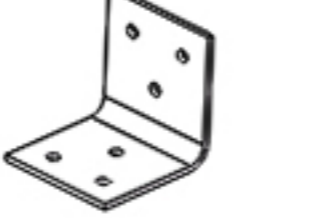

STEP:5

STAMP ID	QTY REQ	BOX	IMAGE
E	10	C	
1	9	A	 M4*70
8	48	A	 M4*40
K1	2	C	
K2	2	C	
K3	2	C	
K4	3	C	

STEP5-1

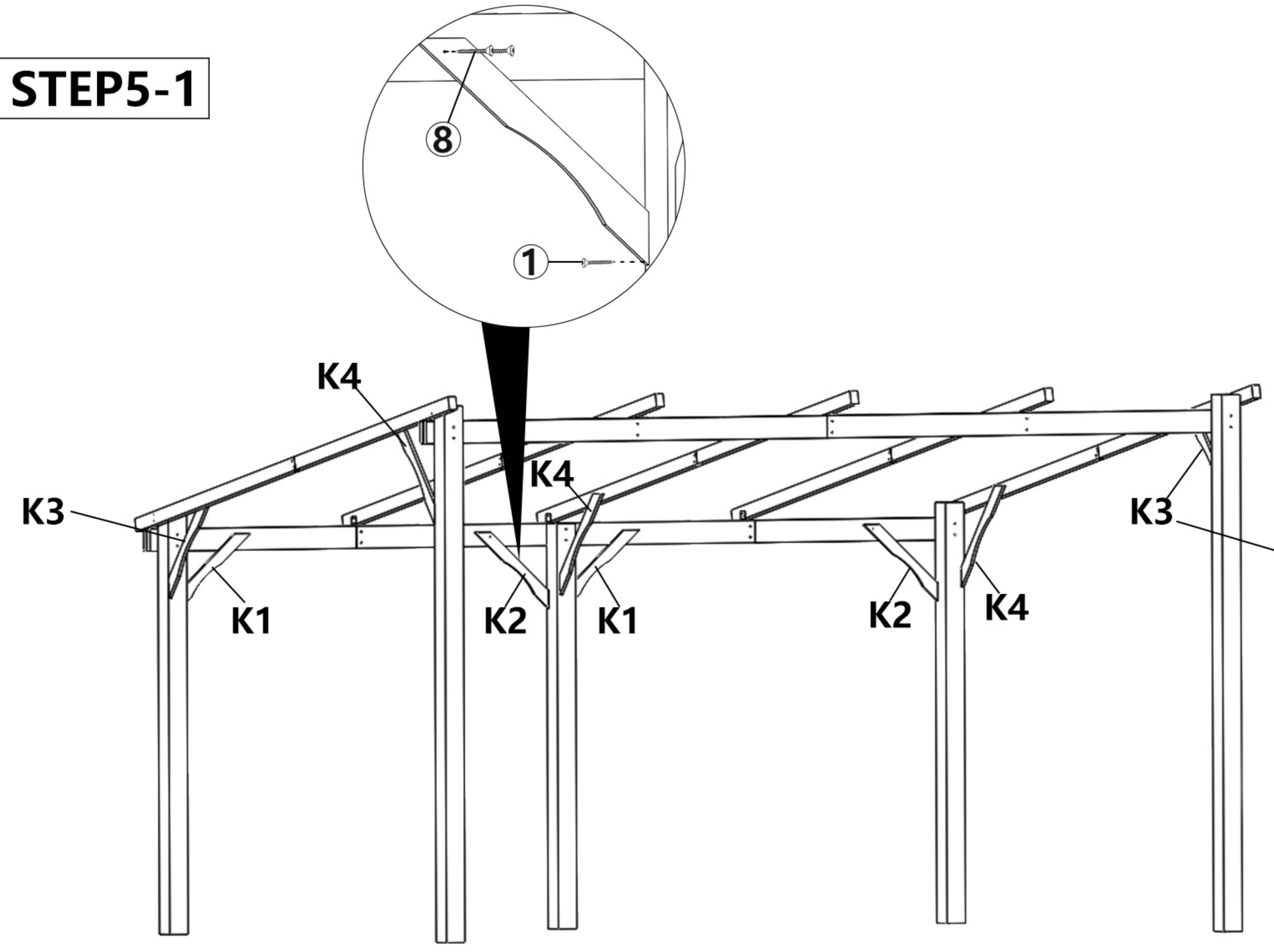

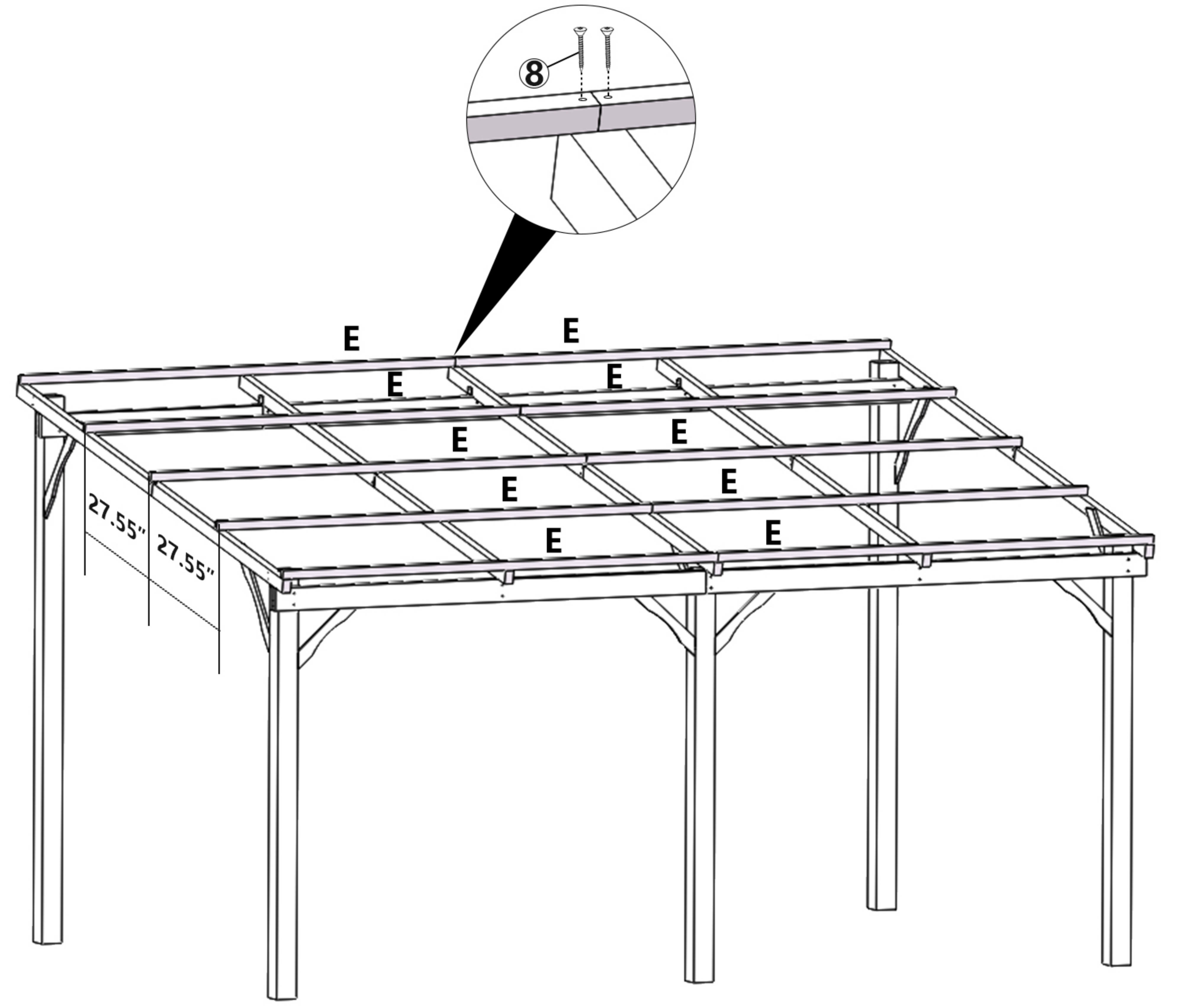

STEP5-2



Please ensure that the concave side faces the ground during installation, and distinguish the accessory model numbers.

STEP:6

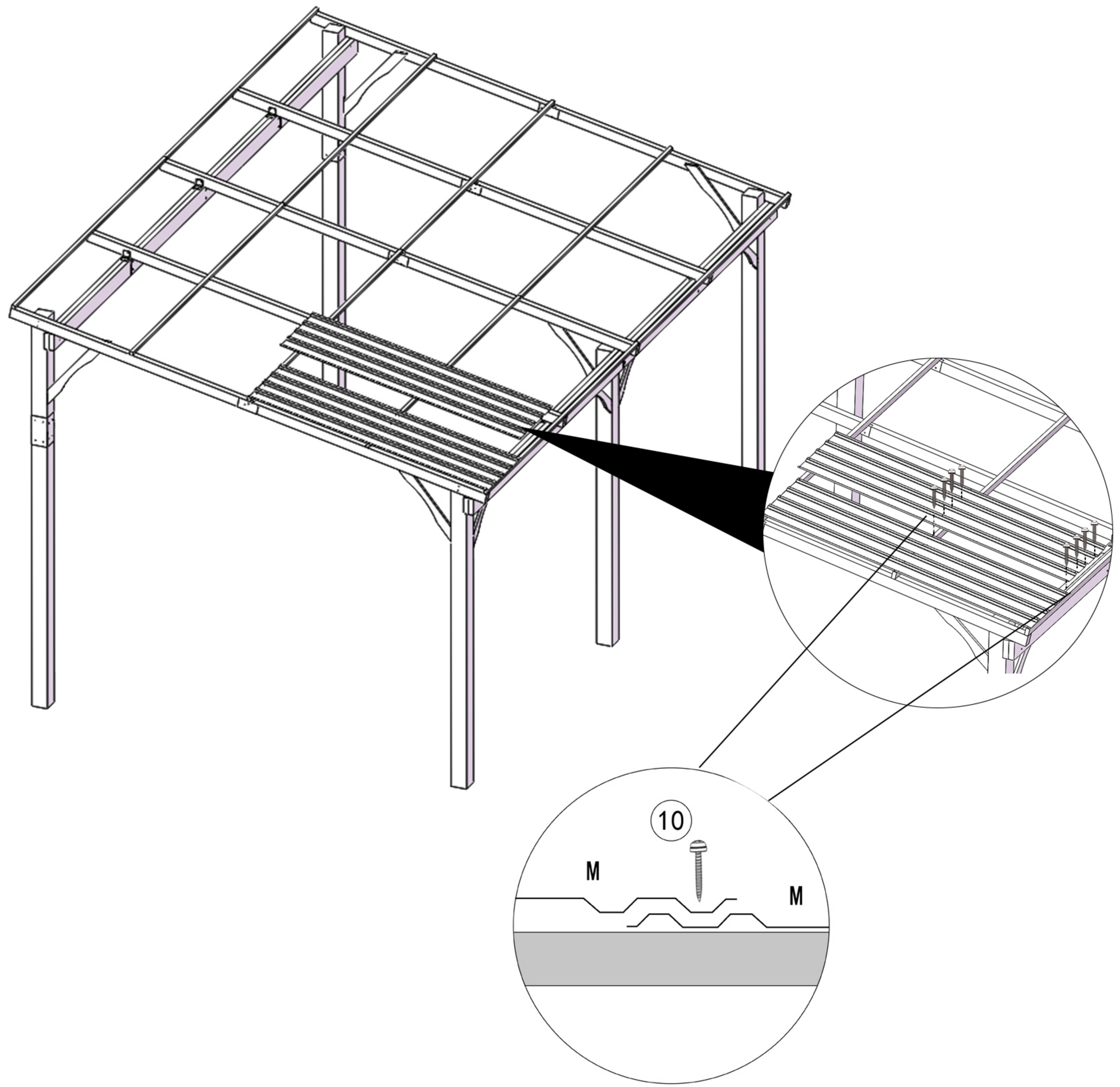
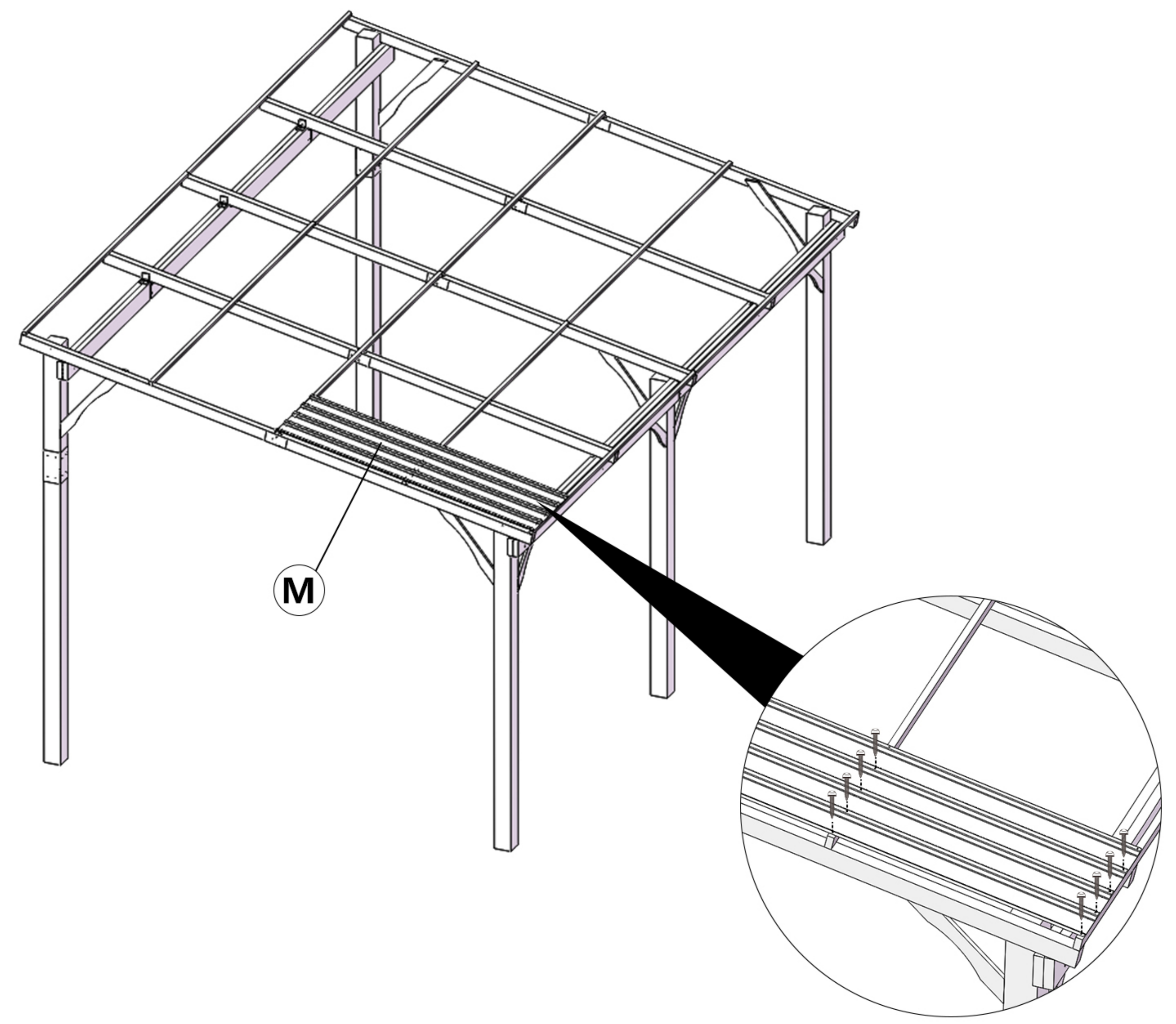

STAMP ID	QTY REQ	BOX	IMAGE
M	18	D	
10	185	A	

Please stack the last piece (the twelfth one) of each row halfway onto the previous piece (the eleventh one).



Install the two components in an overlapping position using a single shared screw

STEP:7

STAMP ID	QTY REQ	BOX	IMAGE
10	185	A	
M	18	D	

STEP7-1

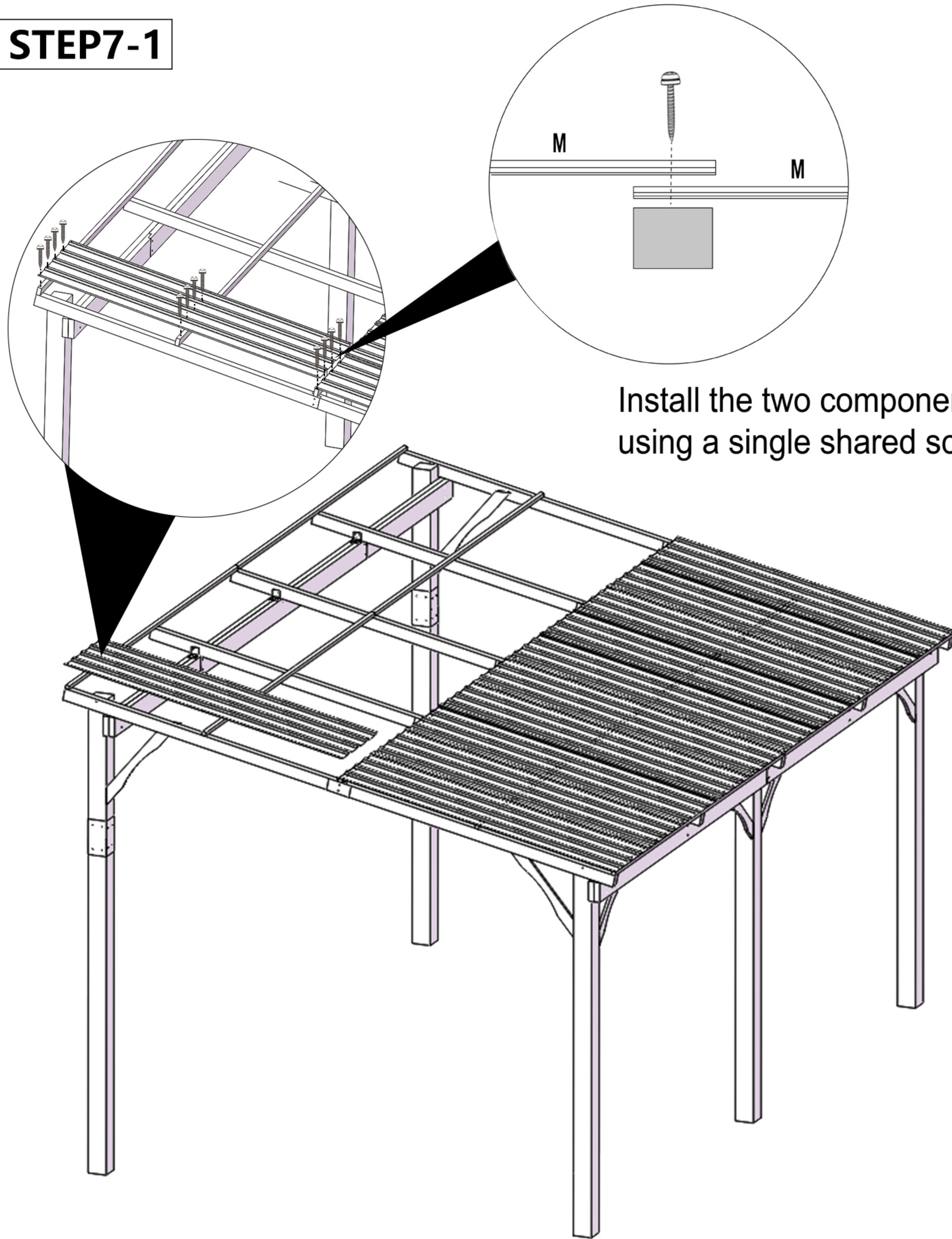

STEP7-2

