

Assembly instructions for step 1/6:

- Tools:** A circle containing an Allen key, a screwdriver, and a wrench. A power drill is shown with a diagonal line through it, indicating it should not be used.
- Warning:** A triangle with an exclamation mark.
- Time:** A clock icon with the text "30'" below it, indicating a 30-minute assembly time.
- Personnel:** A stick figure icon with the number "2" below it, indicating that two people are required for assembly.

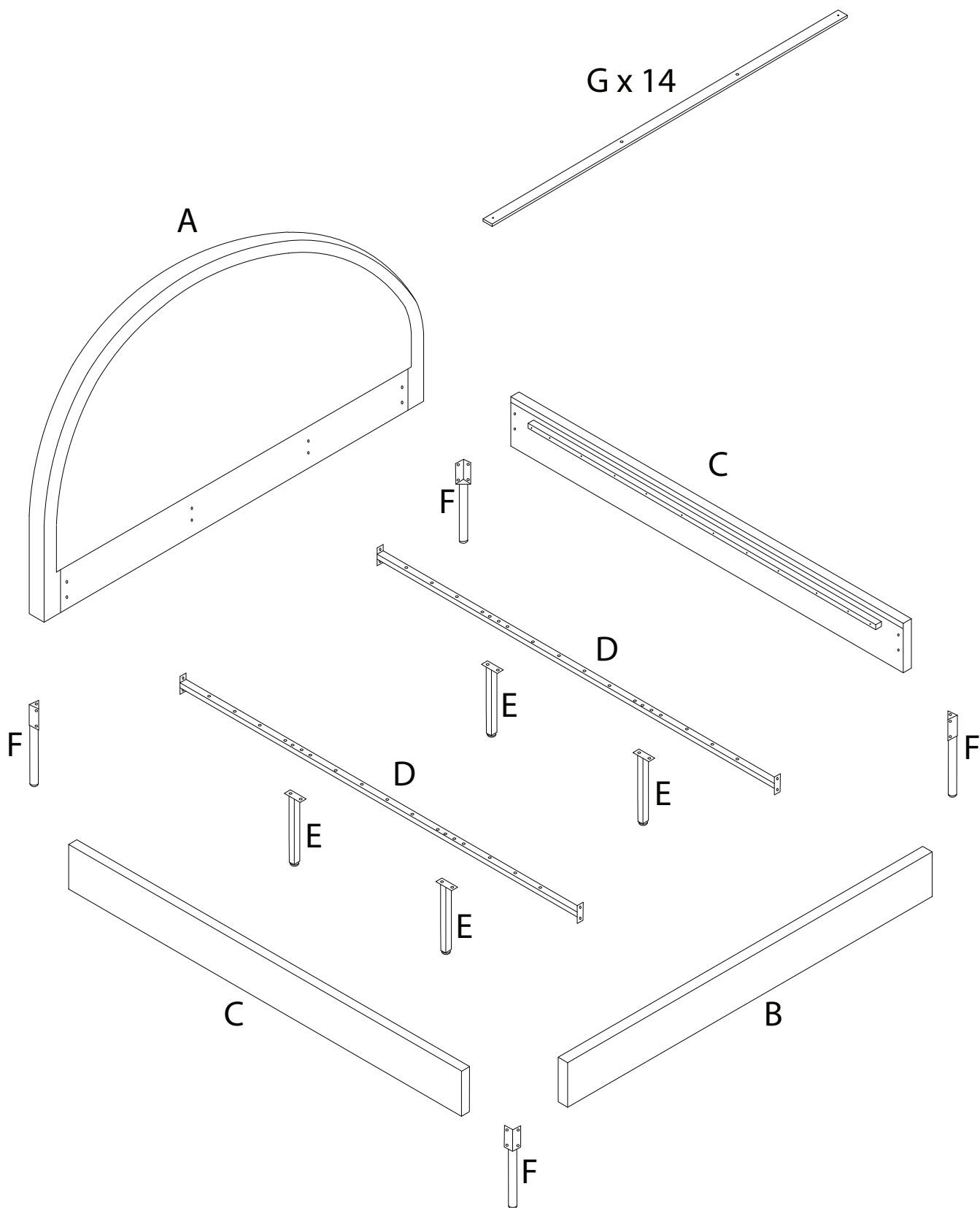

A

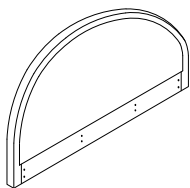

x 1

B

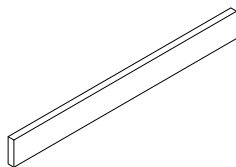

x 1

C

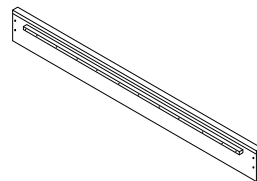

x 2

D

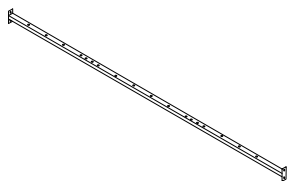

x 2

E

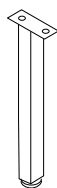

x 4

F

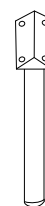

x 4

G

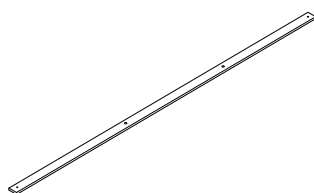

x 14

H

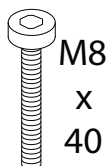

x 36

I

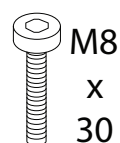

x 24

J

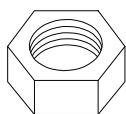

x 36

K

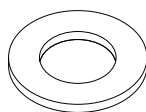

x 60

L

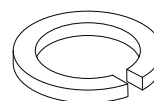

x 32

M

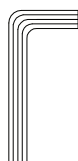

x 1

N







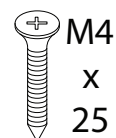

x 1

O

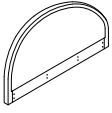
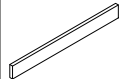





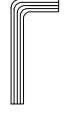

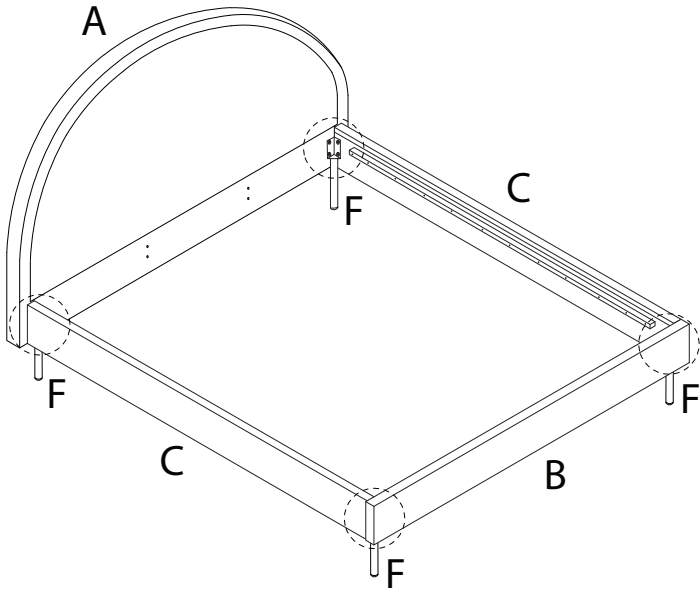

x 28

1

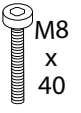
A  x 1	B  x 1	C  x 2	F  x 4	I  M8 x 30 x 16	K  x 16	L  x 16	M  x 1
--	--	--	--	---	---	---	--

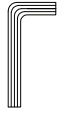

2 x 2

D  x 1	E  x 2	H  M8 x 40 x 4	J  x 4	K  x 4	L  x 4	M  x 1	N  x 1
--	--	--	--	--	--	--	--

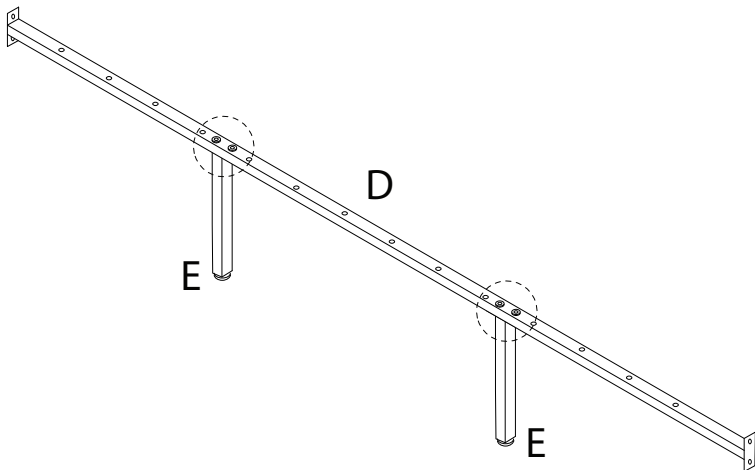

3

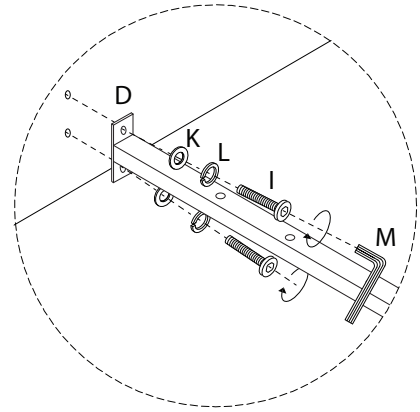
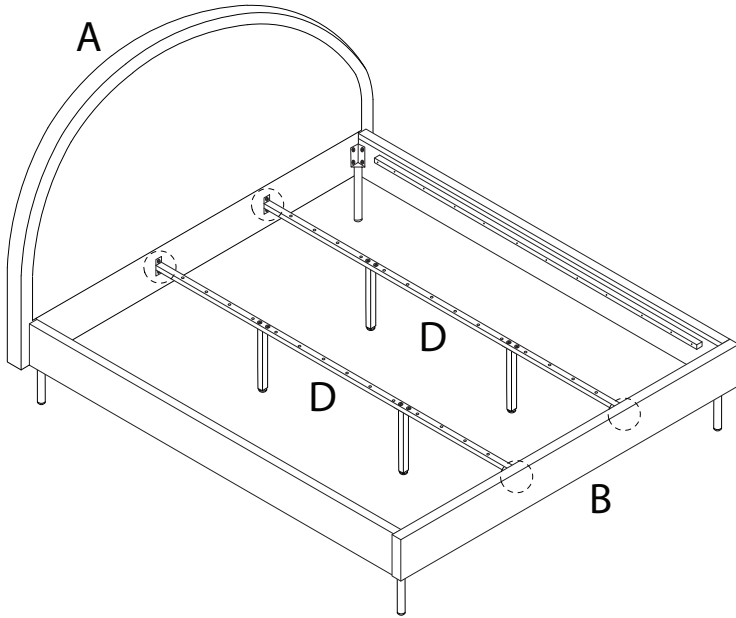
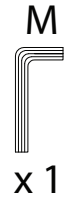
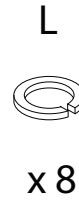

4

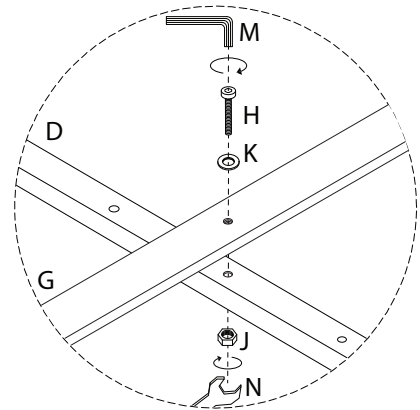
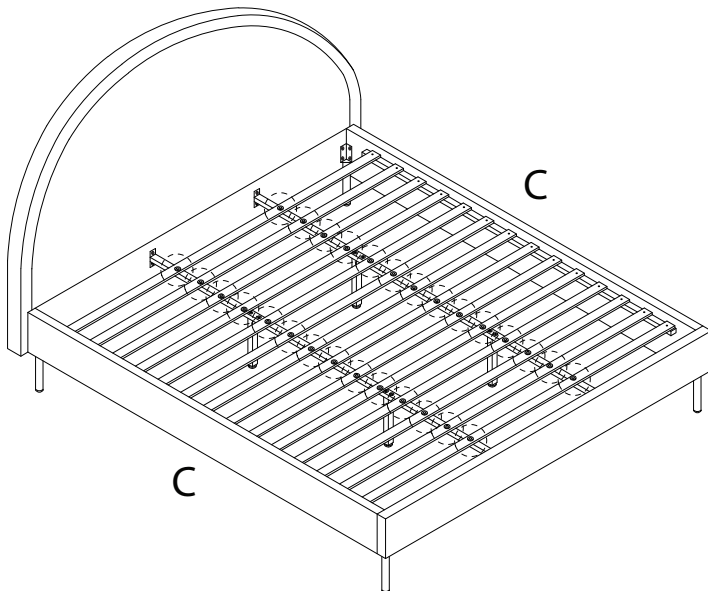
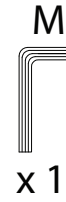
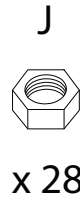
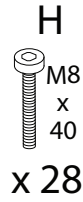
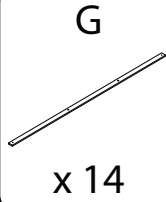

5

O
M4
x
25
x 28

