

# ASSEMBLY INSTRUCTIONS

## 2619

**STEP 1:** Take out the backrest and find the position of the backrest insert and the position of the seat cushion slot. Align the insert with the two slots on the seat cushion simultaneously and gently push down. When you find that it can be fully embedded, press down again to make the insert and the slot completely buckle. When the backrest is completely installed with the seat cushion and there is no looseness, it means it is completed. Just so you know, if the backrest is loose, please check whether the insert is installed correctly. If you want to take the backrest out again, please forcefully pry open the slot and lift the backrest up at the same time.

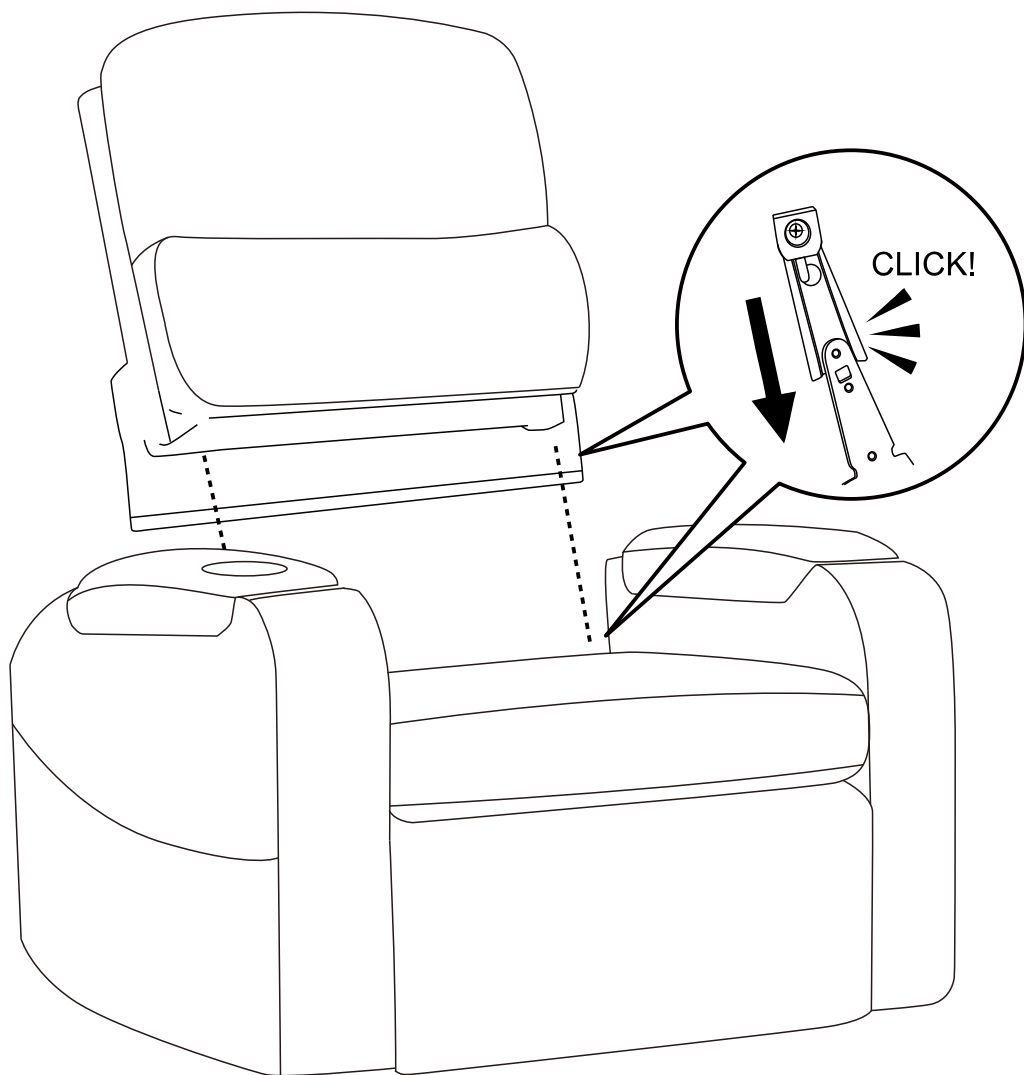

# STEP 2: Please follow the steps to plug in the power ( How to connect a line )

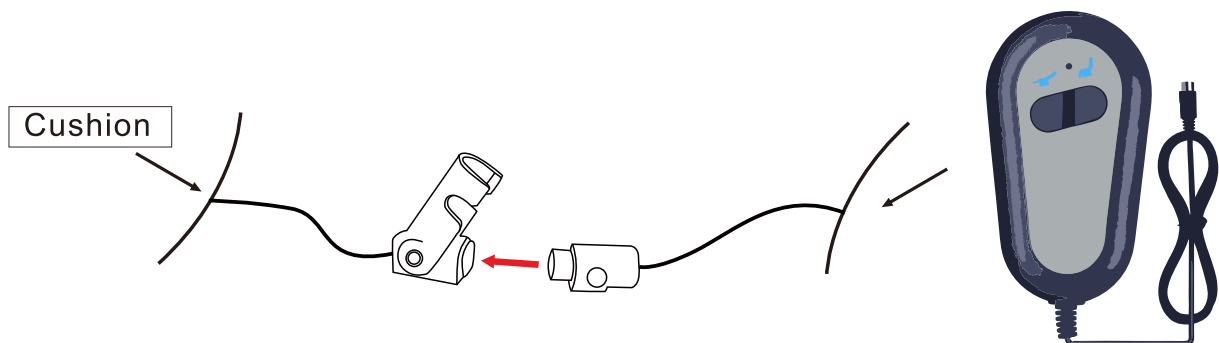
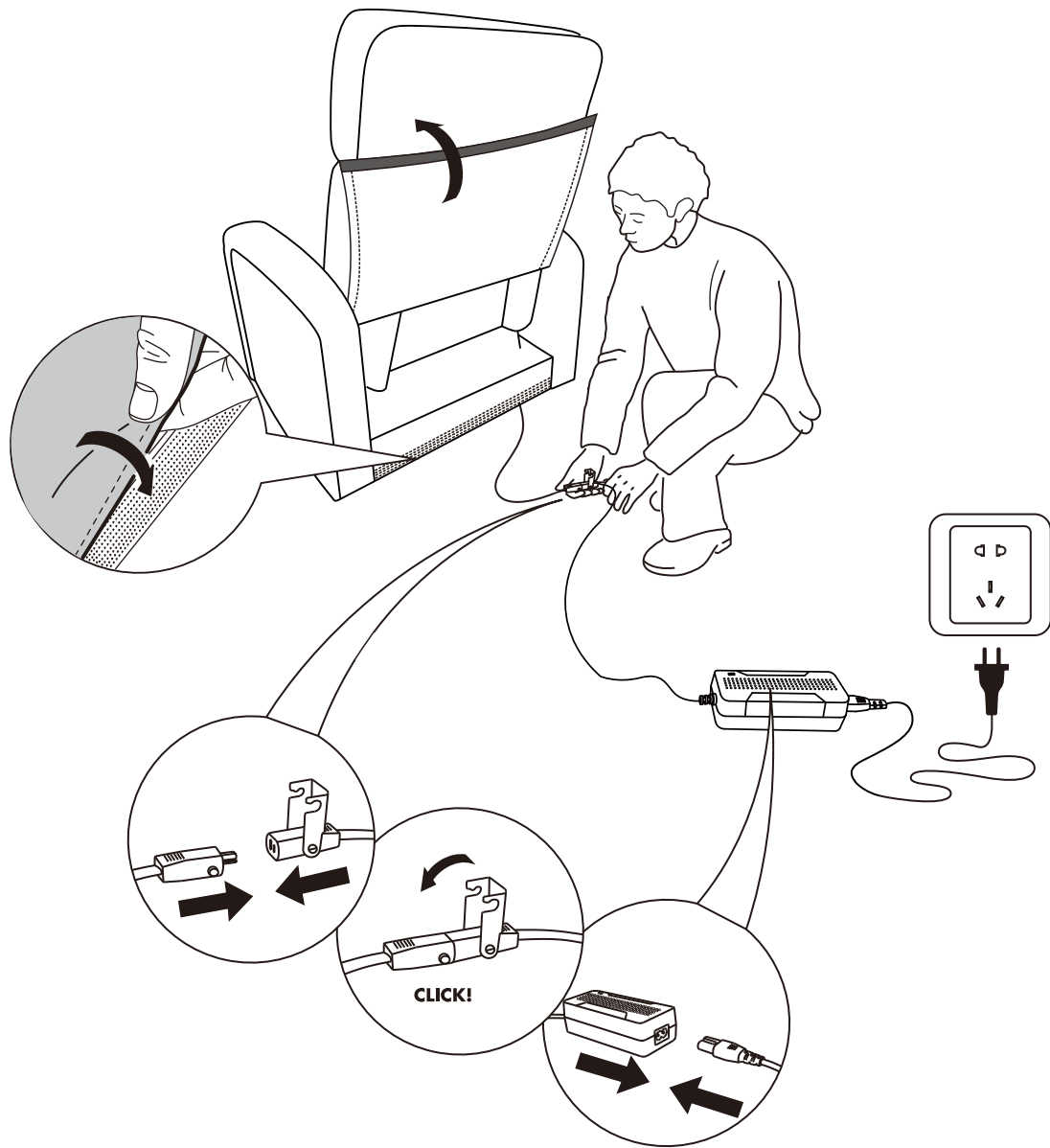

**STEP 3:**

Unfold the sofa



Close the sofa

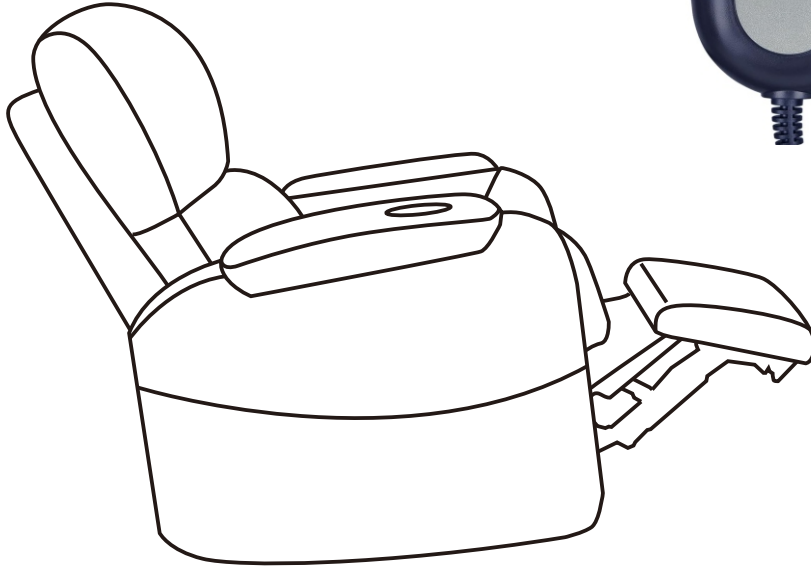

**STEP 4:** Functional display of the Back

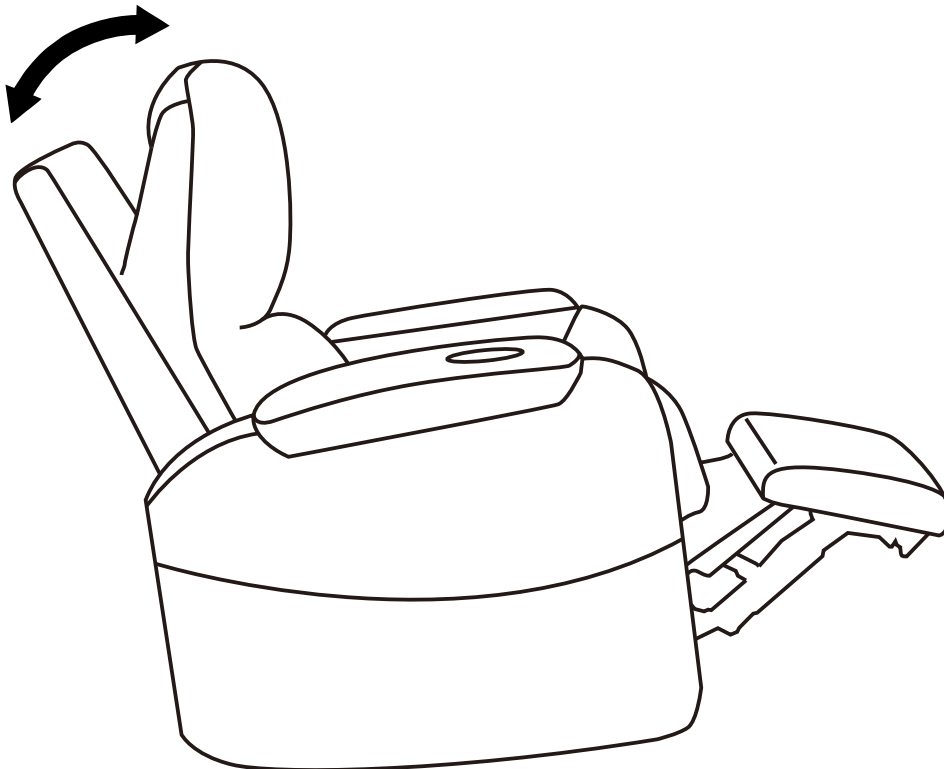

# TO STORE OR CLEAN

Maintenance

Instructions

Rotate reversible cushions regularly.

Turn over & Rotate

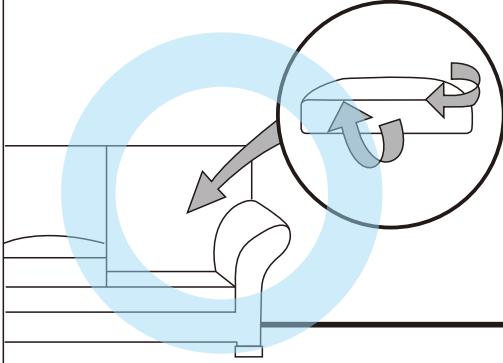

Vacuum your furniture regularly with upholstery tools.

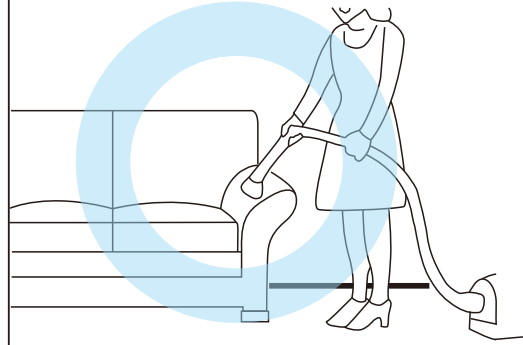

Do not expose your furniture to prolonged periods of direct sunlight.

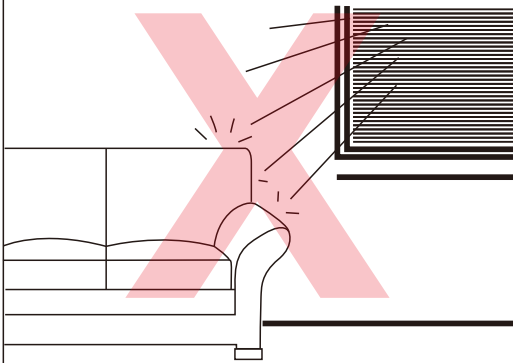

Do not place your furniture close to a radiator or similar heat source.

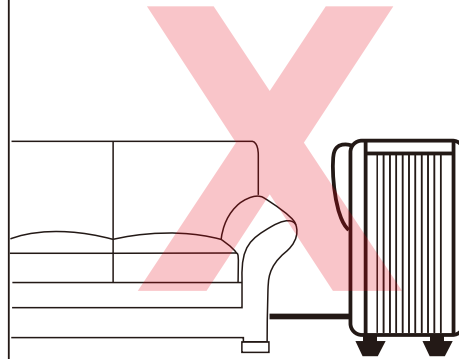

*Are you having difficulty  
with assembly? Missing parts?*

*Please send email with your order No to*

***zhiyu-am@outlook.com***

*For return, please check the return policy with  
the retailer or market place you bought from.*

*Appreciate your purchasing from us.  
Pop up your life by our furniture piece!*