

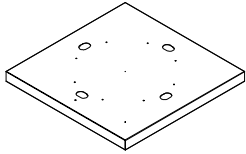







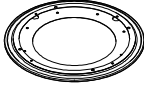

Parts list

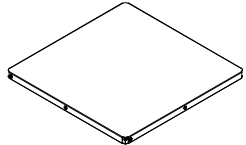
Number	Name	Part	Quantity	Number	Name	Part	Quantity	
1	Base		1	9	Wheel		4	
2	Turntable mechanism		1	10	Screw		40	4 for spare
3	Base plate		1	11	Self-tapping screw		10	2 for spare
4	Side plate		8	12	Fastener		10	2 for spare
5	Shelf		2	13	Wrench		1	
6	Middle shelf		1					
7	Top plate		1					
8	Support rod		8					

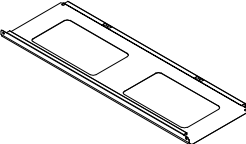

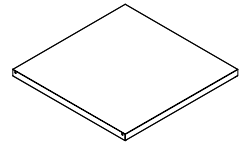
1. Install the turntable mechanism on the base plate.

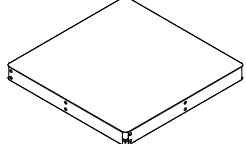
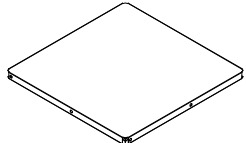
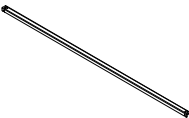
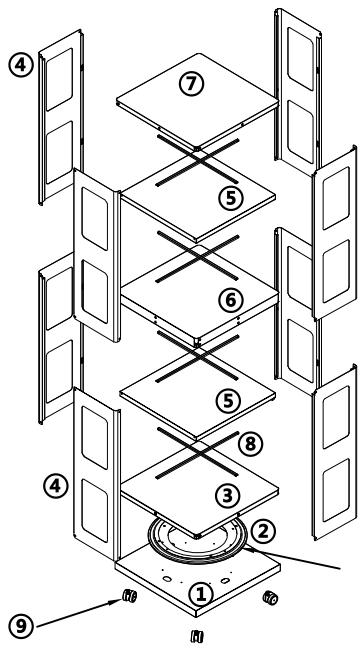
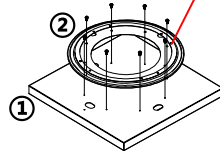

2. Install another base plate and attach the wheels with wrench.

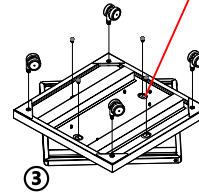

3.

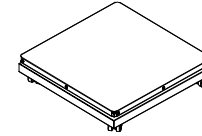

4. Fix one side panel to the side of the base.

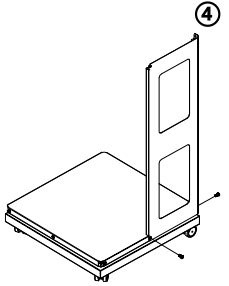

5. Fix the remaining three side panels.

6. Install the middle shelf inside the structure.

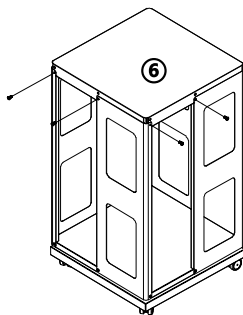
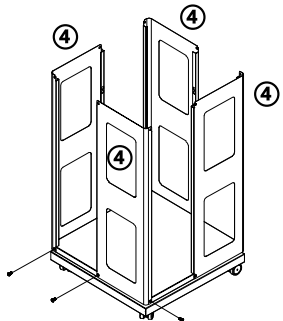

7. Fix the upper side panels on the upper part of the structure.

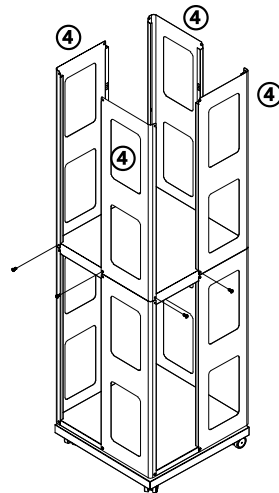

8. Secure the top panel on the top of the structure.

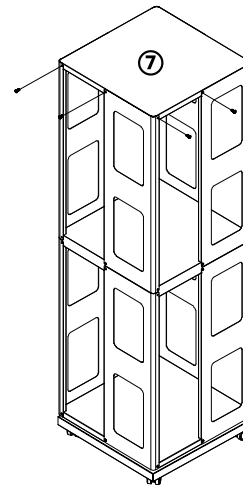

9. Insert the fasteners in the designated positions and place the inner dividers on them.

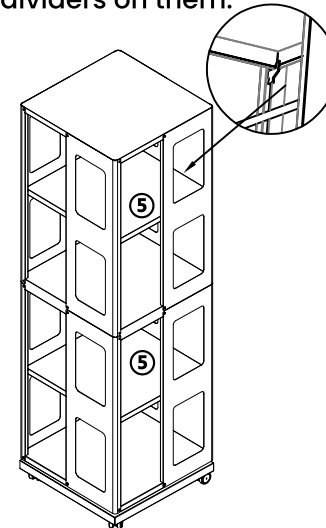

10. Insert the support rods inside the structure.

