

Assembly Instructions

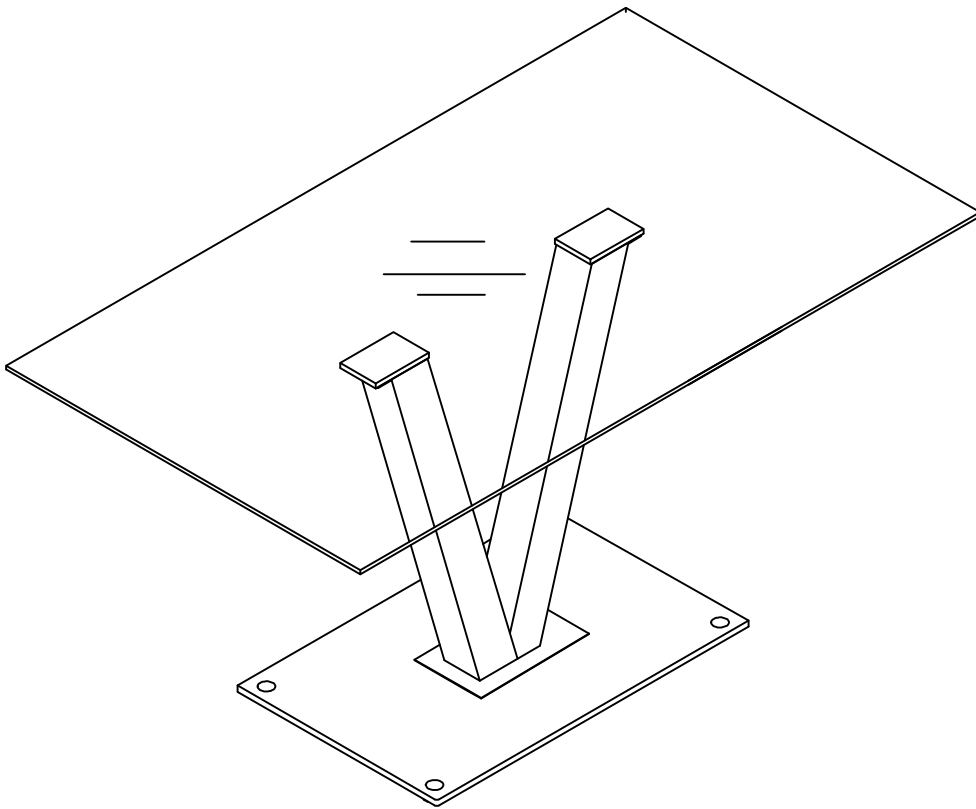

Care & Instruction Manual

Please read and retain these instructions for future reference



Safety and Care Advice

Important – Please read these instructions fully before starting assembly

Check you have all the components and tools listed.

Remove all fittings from the plastic bags and separate them into their groups.

Keep children and animals away from the work area, small parts could choke if swallowed.

Make sure you have enough space to layout the parts before starting.

Assemble the item as close to its final position (in the same room) as possible.

Do not overtighten the nuts to avoid causing damage to the threads.



We do not recommend the use of power drill/drivers **for inserting screws**, as this could damage the unit. Only use hand screwdrivers and Allen keys.

Care and maintenance

Only clean using a damp cloth and mild detergent, do not use bleach or abrasive cleaners.

From time to time check that there are no loose screws on this unit.

This product should not be discarded with household waste. Take to your local authority waste disposal centre.

Components - Parts

Please check you have all the parts listed below

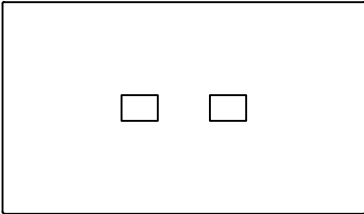

1 x 1



4 x 1

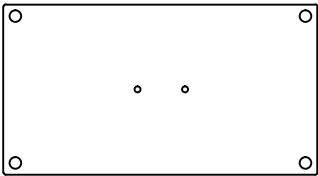

2 x 1

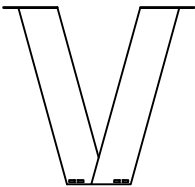









3 x 1

Components - Fittings

Please check you have all the fittings listed below

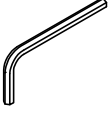
Note: The quantities below are the correct amount to complete the assembly. In some cases more fittings may be supplied than are required.

<p>(A)</p>  <p>M10 x 2</p>	<p>(B)</p>  <p>M10 x 4</p>	<p>(C)</p>  <p>M10 x 4</p>
<p>(D)</p>  <p>M10 x 4</p>	<p>(E)</p>  <p>M10 x 2</p>	<p>(F)</p>  <p>M10 x 2</p>
<p>(G)</p>  <p>M8 x 1</p>	<p>(H)</p>  <p>M10 x 4</p>	

Tools required

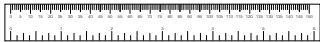

Ruler/tape
measure

screw driver
(not provided)



Ruler - Use this ruler to help correctly identify the screws

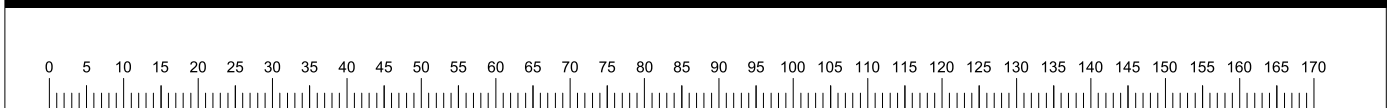

Assembly Instructions

c:

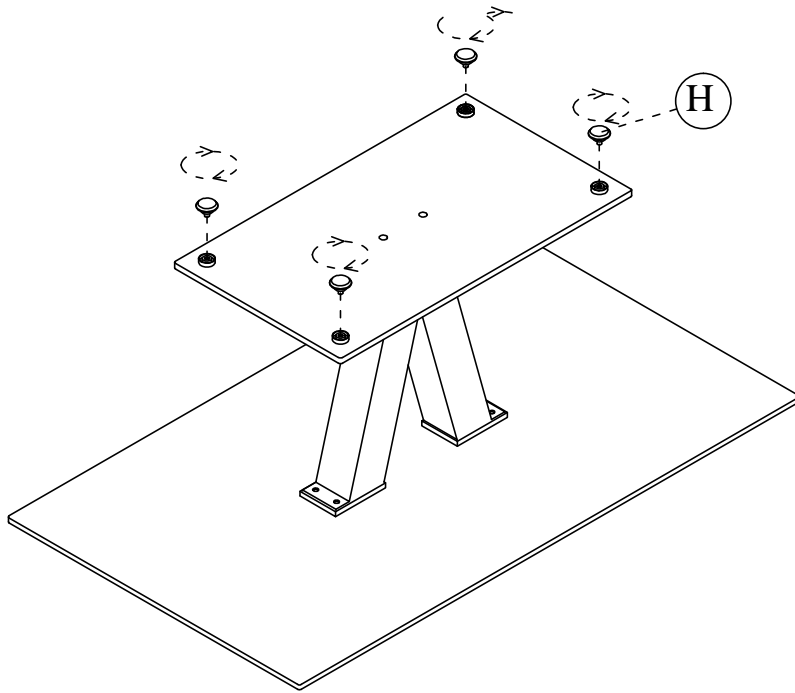

d:

