



RETRACTABLE SCREEN

OWNER'S GUIDE AND INSTALLATION INSTRUCTIONS

DOUBLE PANEL RETRACTABLE DOOR

Thank you for choosing the Double Panel Retractable Door. These instructions describe a **surface mount installation** on a double-hinged door. For help installing, please call us at 888-483-3768.

Please read the complete installation instructions before proceeding.

INSTALLATION TOOLS

Power Drill
Screwdriver
No. 2 Phillips Head Driver Bit
Tape Measure
Hack Saw (required if door width is less than 68" wide)
1/4" Drill Bit
Pencil

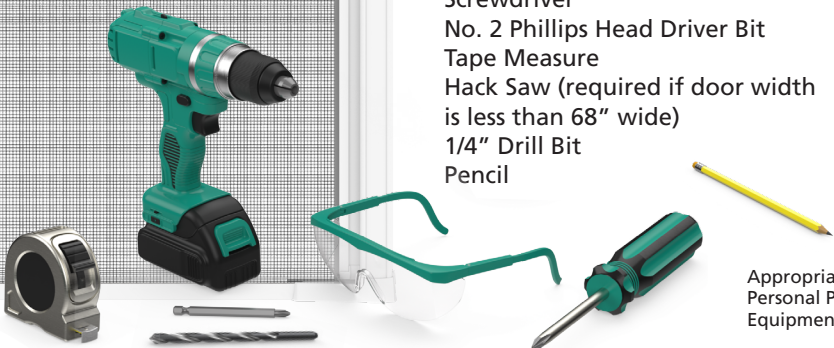

Appropriate
Personal Protective
Equipment



**NEED HELP? CALL US FIRST!
DO NOT RETURN TO STORE.**
For immediate help with your
product, assembly, or parts, call
our toll-free number:
888-483-3768

Watch the installation
before you begin.



SCAN ME

A FRESH APPROACH TO FRESH AIR

Make sure your retractable screen door is the correct size to fit your opening. This retractable screen door fits a double inswing or double outswing door.

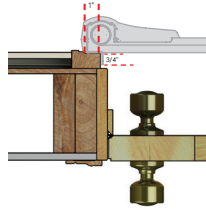

A 3/4" or greater mounting depth by 1" wide mounting surface is required.

<i>DOOR TYPE</i>	<i>MODEL HEIGHT</i>	<i>FITS DOOR WIDTHS*</i>	<i>FITS INSIDE FRAME HEIGHTS</i>	<i>OUTSIDE DIMENSIONS OF ASSEMBLED SCREEN FRAME</i>
Double	Short	68"-72" *	78"-79" (e.g. 6'6" tall doors)	79" H
Double	Standard	68"-72" *	80"-80" (e.g. 6'8" tall doors)	81-3/8" H
Double	Tall	68"-72" *	95"-96" (e.g. 8'0" tall doors)	97-3/8" H

* 2 Cuts are required if the door width is less than 68"

If your retractable screen sits high or low in the opening you may need additional support under the bottom track. If your frame is tall, you may need to add a filler board at the top to close any gaps.

OPTION 1
SITS HIGH IN OPENING

OPTION 2
SITS LOW IN OPENING

FRAME TOO TALL
FILLER BOARD NEEDED
(NOT INCLUDED)

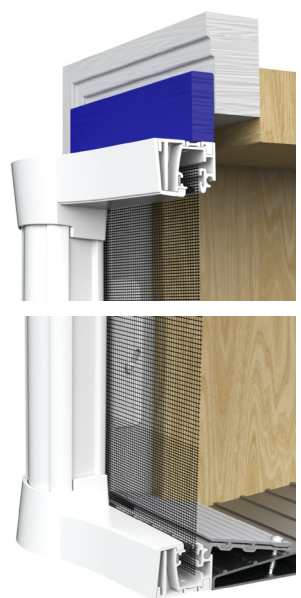



IMPORTANT

Be sure to read all instructions before installing to ensure proper fit and function. Retractable screen doors are not intended to provide security, or restrain objects, animals, or persons.

PARTS LIST & PRODUCT TERMINOLOGY

Use the following illustration and terminology to become familiar with your Retractable Screen Door parts and their location. This will be helpful for following installation instructions.

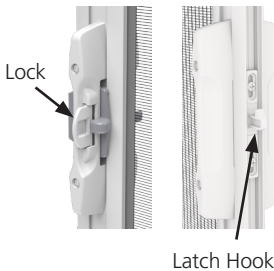
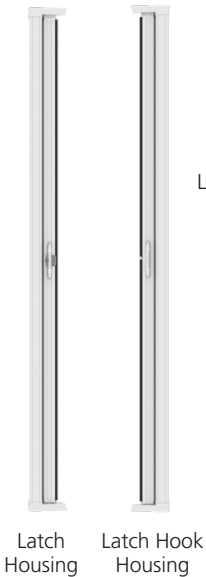
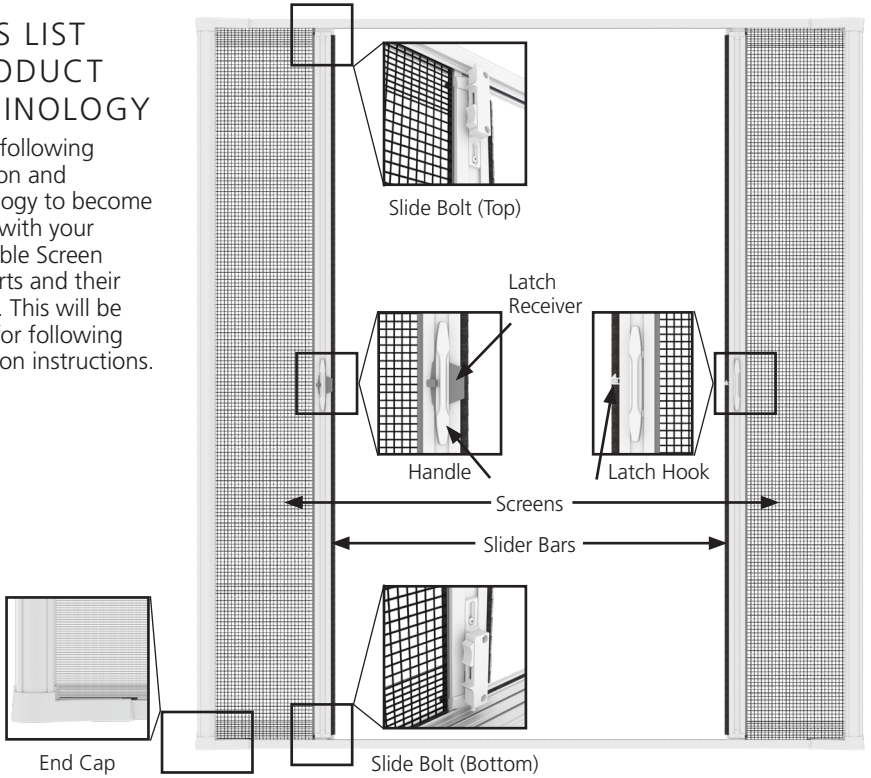

IDENTIFYING SILL TYPE

Before you begin installing your new retractable screen door, it is important to identify your sill and door type. If you have a short sill or an outswing door, you may need to make some modifications before proceeding to the installation steps.

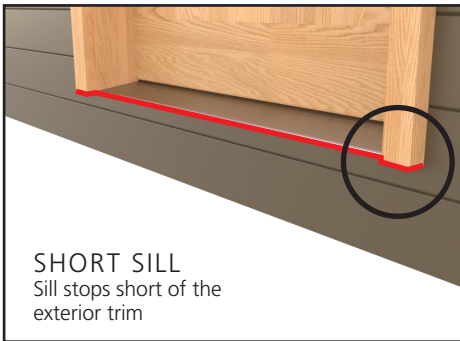
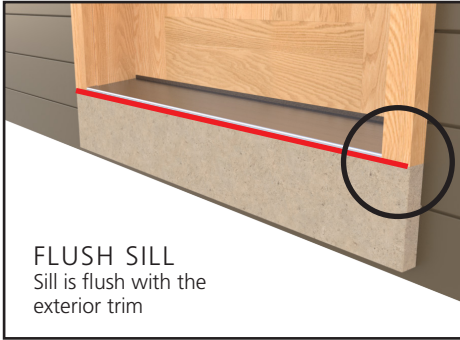

A filler board is not needed when short sills have ground directly underneath the sill.

A filler board (not included) is needed when a short sill sits on top of a step.

Cut the filler board and place under the trim so the top of the filler board is even with the sill.

IDENTIFYING DOOR TYPE

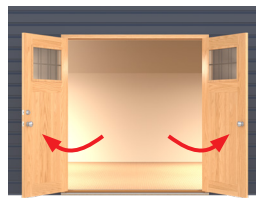
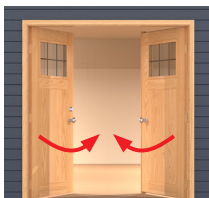

NOTE: Handle modifications will be required to move the lock mechanism to the inside of the home. This step should be completed after the retractable screen is installed (see page 11).

MEASURING DOOR TRIM OPENING

The screen door is designed to fit door openings between 68" and 72" without modifications. If the door opening measures less than 68" wide, the Top and Bottom tracks will require cutting.

Narrow Door Modification (If needed)

Measure the current door trim opening and subtract that width from the standard 68" width to, and then add 1-7/8" calculate the total amount to be cut (example: 68" - 66" + 1-7/8" for a total of 3-7/8" to be cut)

Cut the calculated amount from one end of each track, creating a straight cut. If needed, remove any burrs from the cut end.



EXAMPLE

$$\begin{array}{r} 68'' \text{ standard door width} \\ - 66'' \text{ existing door width} \\ \hline = 2'' \\ + 1-7/8'' \\ \hline = 3-7/8'' \end{array}$$

total amount to be cut from the ends of the top and bottom tracks

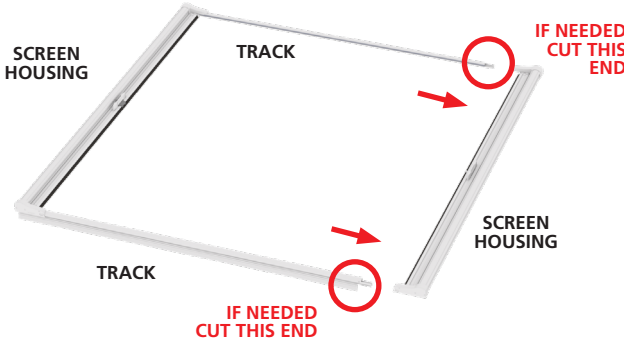

1 ASSEMBLE COMPONENTS

a. Determine which side you wish to open and close and make this the Latch Housing side (without the Slide Bolt).

TIP: Place housing face down on a soft surface to protect the finish during assembly.



Main Left Door

Main Right Door

1 ASSEMBLE COMPONENTS (CONTINUED)

b. Remove all tape and packaging material. If your opening falls within the standard range of 68"-72" width, insert one end of each track into end of the Latch Housing. With the notch towards the front, pull out the Slide Bar just enough to move the Track all the way to the corner. Ensure the Slide Bar is in the Track.

If the opening is less than 68", and the Top and Bottom tracks have to be shortened (See page 5), insert the original uncut ends of each Track into end of the Latch Housing.

c. Slide Sill Plate Assembly onto bottom Track.

NOTE: Do not deploy screen until it is assembled to doorway.

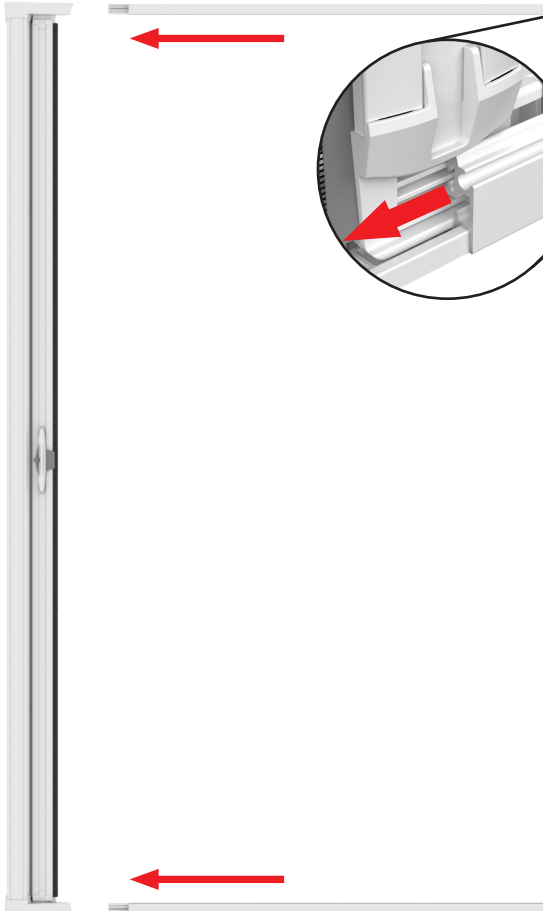
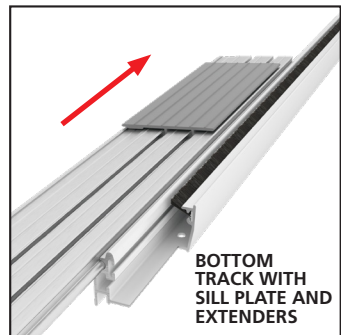
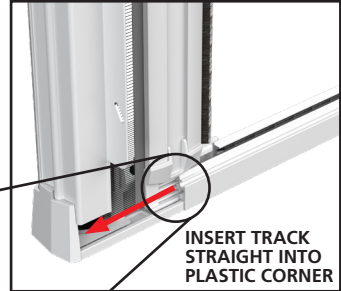
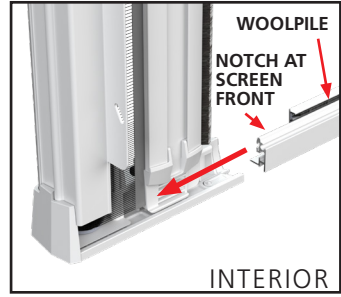

1 ASSEMBLE COMPONENTS (CONTINUED)

d. Insert the other end of the tracks into the Latch Hook Housing.

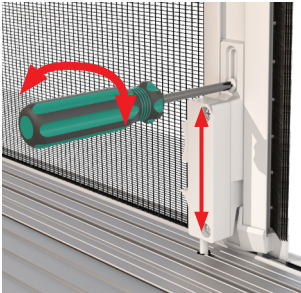
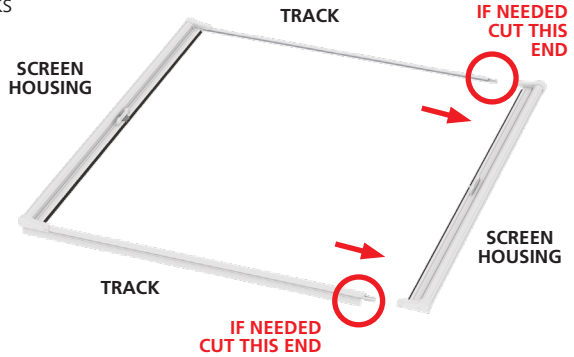
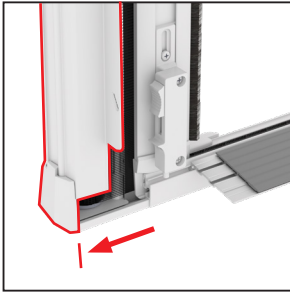

If needed, adjust the Slide Bolt height using the inner-most screw shown. Final adjustment will be performed later.

2 INSTALL SCREEN

a. Push Housings together so the width of the screen frame is at its narrowest. (See page 2 for mounting instructions). Place screen assembly onto door sill.

For flush and short sills, the bottom edge of the sill should be fully supported by filler board or ground. For long sills, the assembly rests on top of the sill.

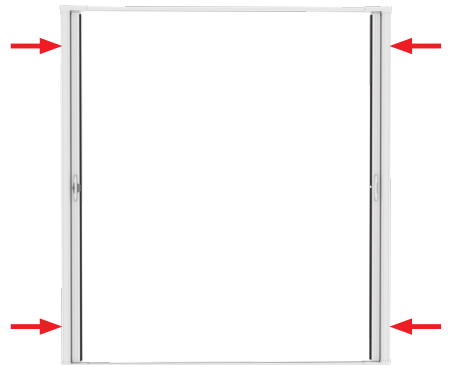
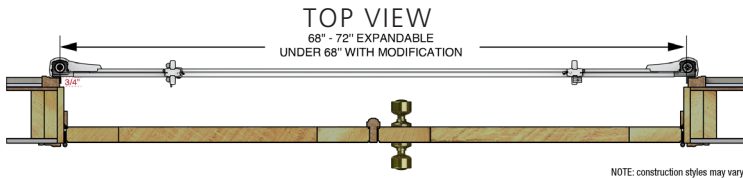

2 INSTALL SCREEN (CONTINUED)

b. Extend Housings to left and right evenly until flanges are snug to the edge of the door Jamb.



3 SECURE SCREEN

a. Insert **ONE** housing screw into the pre-drilled screw hole at the top of the Housing flange to hold the frame in place. **Do not tighten completely.**



#6 x 1-1/4"
Housing Screws
Qty: 1
Painted



b. Center the Sill Plate Assembly on the door sill and slide the Sill Plate Extender to each side to fill gaps.

NOTE: For a tailored fit, use a scissors to trim each Sill Plate Extender.

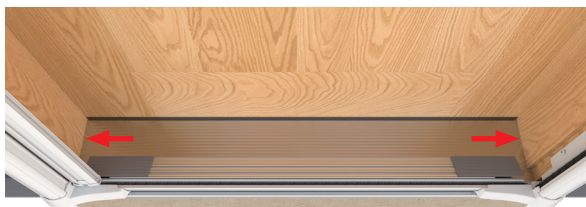

3 SECURE SCREEN (CONTINUED)

c. Drive sill screws approximately 4" from either end to anchor Sill Plate & Extenders in-place, and 4" to the left and right of center to further anchor the Sill Plate. Do not over tighten.



#6 x 3/4"
Sill Screws
Qty: 4
Unpainted



d. Insert the (3) remaining Housing screws into the pre-drilled holes on both vertical Housing flanges. Tighten all screws.

4 VERIFY LATCH ALIGNMENT

a. Deploy Slider Bar with Latch Hook unit it reaches the middle of the Track. Mark the position of the Slide Bolts on the Sill Plate and top molding. If needed, adjust Slide Bolt positions using screw shown in Step 2a.



b. Release the Slider Bar and drill 1/4" holes in the Sill Plate and the top molding. Remove any burrs or sharp edges. Deploy the Slider Bar with Latch Hook to the middle of the track. Drop Slide Bolts into these top and bottom holes.

Note: Drill only deep enough for the Slide Bolt to fully engage.



4 VERIFY LATCH ALIGNMENT (CONTINUED)

c. Deploy Slider Bar with Latch until it reaches the middle of the track and latches onto the hook. Verify the Latch and Latch Hook align properly. Latch Hook can be adjusted as needed with a hand screwdriver.

TIP: The Latch Hook comes pre-installed and will face either up or down depending on the chosen Screen Housing orientation (see page 5). If you prefer to operate the screen by always pushing either down or up and, that is not the current operation, remove the two screws that hold the Latch Hook, turn the Latch Hook in the opposite direction and then reinstall the screws and adjust the Latch Hook as needed.

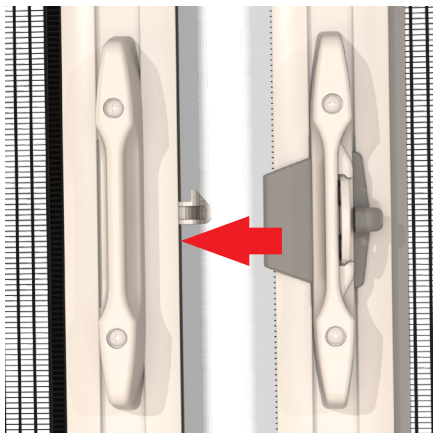
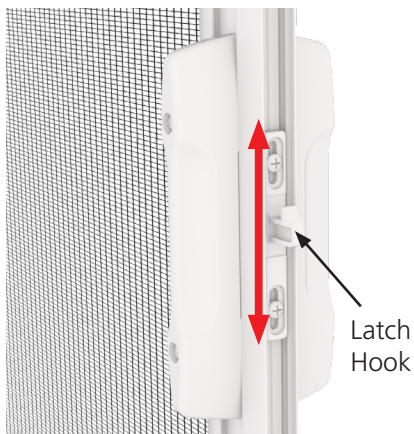

LATCH OPERATION

On the handle interior, there is a Handle Lock. The lock is swiveled to lock or unlock the handle. When the screen is covering the opening and the handle is in the locked position, the screen cannot be unlatched and opened.

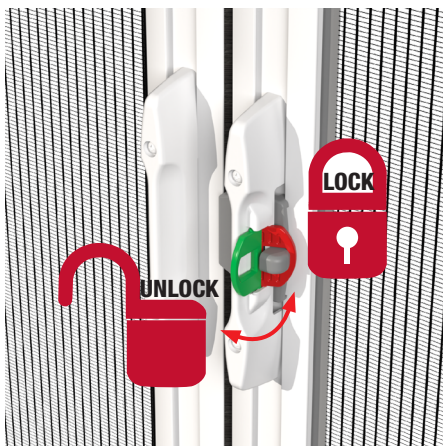

DOUBLE OUTSWING ONLY

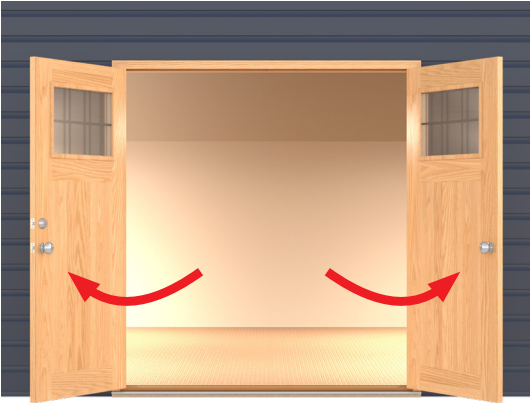

Outswing Door Handle Modification (If needed)

Once the unit is installed, move the gray lock mechanism to the inside of the home.

1. Disengage the handle lock and remove the (2) screws from the handle.
2. Remove both handles (NOTE: the gray latch will be loose).
3. Remove the gray latch from the Slider Bar and reverse it, then press the latch over the Slider Bar.
4. Place the handle with the lock.
5. Align and insert the screws through the screw holes. Position the outside handle over the screws and align the (6) small dimples with the corresponding indentations on the inside handle.
6. Tighten the (2) screws with a hand screwdriver.



Lock Mechanism

Frequently Asked Questions

Is maintenance required on my Retractable Screen Door?

Dirt and debris should be vacuumed out of the tracks periodically. Do not use oily lubricants (i.e., WD40) on the track, as this may attract dirt and hinder operation. If needed, occasional use of a silicone-based lubricant is acceptable.

Can the Retractable Screen Doors be installed on stucco homes without a wood door frame?

No, the retractable screen is a surface-mount installation that requires a door frame/brickmold/door trim for proper attachment.

What if there are gaps above the guide rail or in the corners?

This retractable screen is mounted on the surface of a brickmold and may expose small gaps between the opening. A decorative trim or caulk may need to be applied to fill any gaps.

What if my retractable screen door retracts slowly, or doesn't deploy at all?

There could be various reasons for slow retraction or no deployment of the screen:

- Be sure to clean dirt and debris out of the tracks.
- Look for nicks or bends in the track.
- Examine the weatherstrip for displacement or rips that may prevent the screen from operating smoothly.
- Confirm the unit was installed square to the door frame.

If you are still experiencing difficulty, contact our Customer Care Team at 888-483-3768 for assistance.

Someone walked through my screen and now it does not function properly.

If the screen is frayed, has holes or is creased, or the track is bent, contact our Customer Care Team at 888-483-3768 to order a replacement part.

Once the screen has been assembled, how do I remove the top and bottom Tracks?

Remove the screen from the door opening and lay it on a soft, clean surface. Locate the plastic corner End Caps that are found at each end of the Decorative and Screen Housings. On the outer ends each plastic End Cap has a small flexible tab. Using a flat tip screwdriver, gently lift the small flexible tab while lightly pulling the track out of the plastic End Cap. Repeat for each end.

What about wind, weather and the intended use of my Retractable Screen Door?

This retractable screen provides insect protection and supports fresh, natural ventilation. The screen should not be left continually open, be persistently exposed to wind, sun, rain or other harsh conditions. The screen is for insect protection and is not intended to provide security or restrain objects, animals or persons. Retract the screen when not needed and use the screen only during low-wind conditions. Before retracting the screen, check that the edges of the screen fabric are riding completely inside the tracks and guide rails. If necessary, use your fingers or a soft smooth instrument to position the edges of the fabric inside the guide rails before retracting the screen.

Limited Lifetime Warranty

Retractable Screen Doors include a Limited Lifetime Warranty. Damage to screen such as tears are not covered under the warranty. Labor cost, re-installation fees are not covered under warranty.