

SKYPERGS LITE

SMP-SPL-IN/EX-LED-33/34/364/44

Dimensions:

3×3/3×4/3.6×4/4×4M

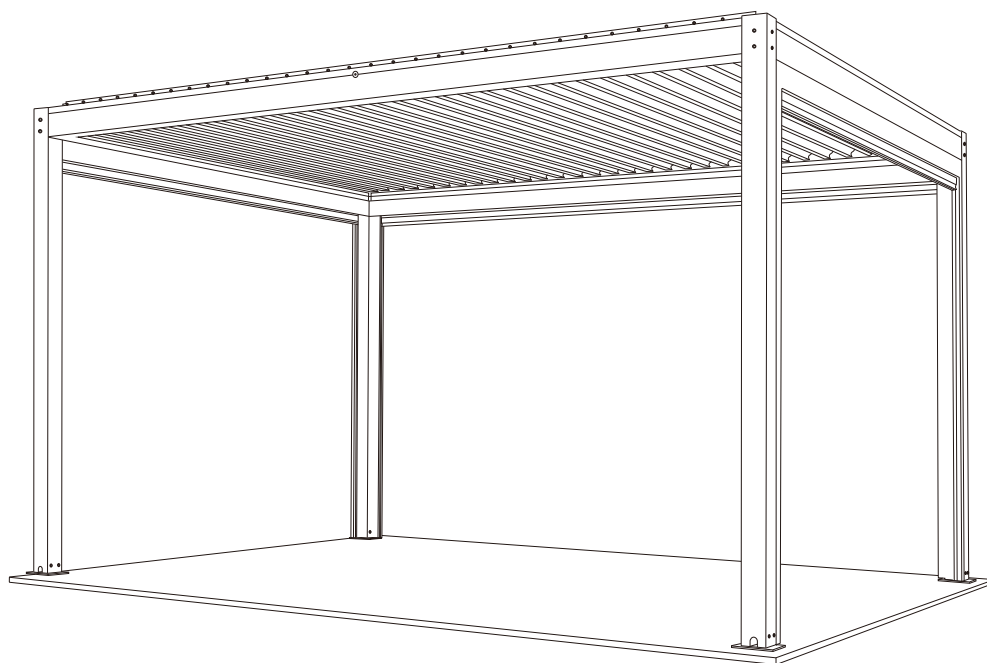

USER MANUAL &
SAFETY INSTRUCTIONS



Installation video

Content









Tools and manpower.....	3
Parts list.....	4
Product Description and Safety Instruction.....	8
Mounting and usage.....	10
Dismounting.....	15

Tools and Manpower

Dear Ladies & Gentlemen

Congratulations and thank you for choosing to buy the SKYpergs Lite Pergola from our company. To enjoy this product for a long time and for your own and the safety of other people, please follow the assembly instructions. Before you start the assembly process and then using the Pergola, we suggest you are best to get familiar with this product. Make sure all parts listed up in below packing lists are delivered and Intact. If you find that there are parts missing or damaged please do not install the pergola but contact us immediately. Do not start the assembly process if parts are missing or defective.

Additional tools

<p>a LADDER</p>  <p>>1.5M x2 13MM</p>	<p>b M10/ 13 OPEN WRENCH SUPPLIED</p>  <p>16MM</p>	<p>c RUBBER MALLET</p> 	<p>d TAPE MEASURE</p> 
<p>e 5MM HEXAGON WRENCH SUPPLIED</p> 	<p>f PENCIL</p> 	<p>g SPIRIT LEVEL</p> 	<p>h ELECTRIC DRILL</p> 

Recommended: At least 4 people















Normally we recommend that the pergola must be assembled by at least four people (qualified technicians / authorised installers).



Parts List

SIZE: 300X300CM











PARTS LIST, hardware and other parts:

① M8×20 Countersunk screw  × 16	② Hand crank  × 1	③ Base plate  × 4
④ Post up plate  × 4	⑤ M10 screw cap  × 2	⑥ M8×20 HEX machine bolt  × 8
⑦ M8×20 HEX half tooth bolt  × 46	⑧ DAP25 Plastic spacer  × 46	⑨ M8 Locking nut  × 46
⑩ Strength pivot pin  × 2	⑪ Gutter connector  × 4	⑫ Connector  × 1
⑬ Expansion bolt  × 16	⑭ Drive shaft  × 1	

Parts List















SIZE: 300X300CM

Aluminum profile parts list:

<p>(A) Beam with pivot bushing</p>	<p>(B) Beam with gear and pivot bushing</p>
 <p>x 1</p>	 <p>x 1</p>
<p>(C) Beam</p>	<p>(D1) Post+post connector</p>
 <p>x 2</p>	 <p>x 2</p>
<p>(D2) Post+post connector</p>	<p>(E) Short gutter</p>
 <p>x 2</p>	 <p>x 2</p>
<p>(F) Long gutter</p>	<p>(G) Common louver</p>
 <p>x 2</p>	 <p>x 21</p>
<p>(H) Centre louver</p>	<p>(I) Driving louver</p>
 <p>x 1</p>	 <p>x 1</p>
<p>(J) Control rod</p>	
 <p>x 2</p>	

Parts List











SIZE: 300X400/360X400/400X400CM
PARTS LIST, hardware and other parts:

① M8×20 Countersunk screw  × 16	② Hand crank  × 1	③ Base plate  × 4
④ Post up plate  × 4	⑤ M10 screw cap  × 2	⑥ M8×20 HEX machine bolt  × 8
⑦ M8×20 HEX half tooth bolt  × 64	⑧ DAP25 Plastic spacer  × 64	⑨ M8 Locking nut  × 64
⑩ Strength pivot pin  × 2	⑪ Gutter connector  × 4	⑫ Connector  × 1
⑬ Expansion bolt  × 16	⑭ Drive shaft  × 1	

Parts List

SIZE: 300X400/360X400/400X400CM

Aluminum profile parts list:



<p>(A) Beam with pivot bushing</p>	<p>(B) Beam with gear and pivot bushing</p>
 <p style="text-align: right;">× 1</p>	 <p style="text-align: right;">× 1</p>
<p>(C) Beam</p>	<p>(D1) Post+post connector</p>
 <p style="text-align: right;">× 2</p>	 <p style="text-align: right;">× 2</p>
<p>(D2) Post+post connector</p>	<p>(E) Short gutter</p>
 <p style="text-align: right;">× 2</p>	 <p style="text-align: right;">× 2</p>
<p>(F) Long gutter</p>	<p>(G) Common louver</p>
 <p style="text-align: right;">× 2</p>	 <p style="text-align: right;">× 30</p>
<p>(H) Centre louver</p>	<p>(I) Driving louver</p>
 <p style="text-align: right;">× 1</p>	 <p style="text-align: right;">× 1</p>
<p>(J) Control rod</p>	
 <p style="text-align: right;">× 2</p>	

Product Description and Safety Instructions

Description:





Make the most of your outdoor living area with your pergola. Relax and enjoy the outdoors while being protected from sun. The coated aluminum frame pergola is perfect for shading your garden, deck, courtyard or any patiospace.

Symbol explanation:

-  This warning triangle calls attention to hazards that can lead to death or to severe injuries or which are important for the functioning of the Pergola.
-  This sign identifies important notes.

Safety Instructions:

Warning: For the safety of you and other people it is important to follow below instructions and obey warnings.

-  To install this pergola technical knowledge is necessary. Do not mount this pergola yourself but contact a professional workman for help if:
 - ◆ you are unsure if the pergola can be mounted on the place you chose for installation.
 - ◆ you do not understand the instruction manual or parts of it.
 - ◆ you do not have necessary tools available.
 - ◆ you do not have necessary technical knowledge
-  A minimum of Four healthy adults are required to move and install the pergola as the product is big and heavy. Do not try to install the pergola alone. If the pergola falls, it could cause serious injuries and damages! Contact an authorized assembler for help.
-  Do not install the pergola when you find the spare parts damaged or missing. Contact your dealer.
-  Keep children and pets out of the working area during assembly and adjustments.

Product Description Safety Instructions

- ⚠ This product and its fixing parts are only suitable for installation on a plain cement wall or stable brickwork. If the wall/ brickwork shows cracks you have to consult a professional.
- ⚠ Nobody is allowed to change the products' design and structure without the permission of manufacture or authorized deputy.
- 👉 Please make sure that your hands are clean at the time of the assembly; otherwise you may soil frame.
- ⚠ Nobody is allowed to climb onto the Pergola. Hanging anything on the Pergola is forbidden.





Sheeting was used to protect the paint. This must be removed afterwards. This structure is a non-permanent structure and the warranty does not cover damage under extreme weather conditions including heavy rain, high winds or if exposed to high heat from heaters or BBQs.

Safety precautions should always be followed when assembling and using this product to reduce the risk of personal injury and damage to equipment. Please read all instructions before assembly and use. Never leave children unattended around/ under this pergola. Do not attempt to assemble or use the pergola in moderate or heavy wind conditions. Always keep the pergola louver open and secure it during heavy winds or extreme weather conditions to avoid damage to the pergola or personal injury.

Mounting and usage

Step 1:

Install ③ base plate on D1(post)、D2(post);
Four posts installed as photo:

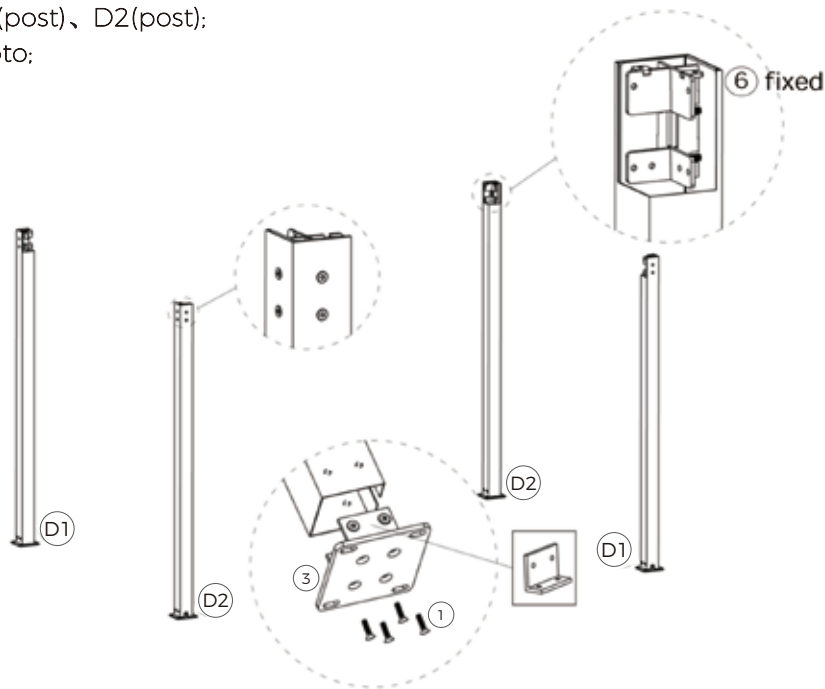

① M8×20 Countersunk screw	
	× 16
③ Base plate	
	× 4
D1 Post+post connector	
	× 2
D2 Post+post connector	
	× 2



Step 2:

Install ④.⑤.⑥.beams as photo;

Loosen the ⑥ original screws, Connect D1(post) and A. In the same way to connect D2(post) and A. In the same way to fix the another side.

④ Beam with pivot bushing	
	× 1
⑤ Beam with gear and pivot bushing	
	× 1
⑥ Beam	
	× 1

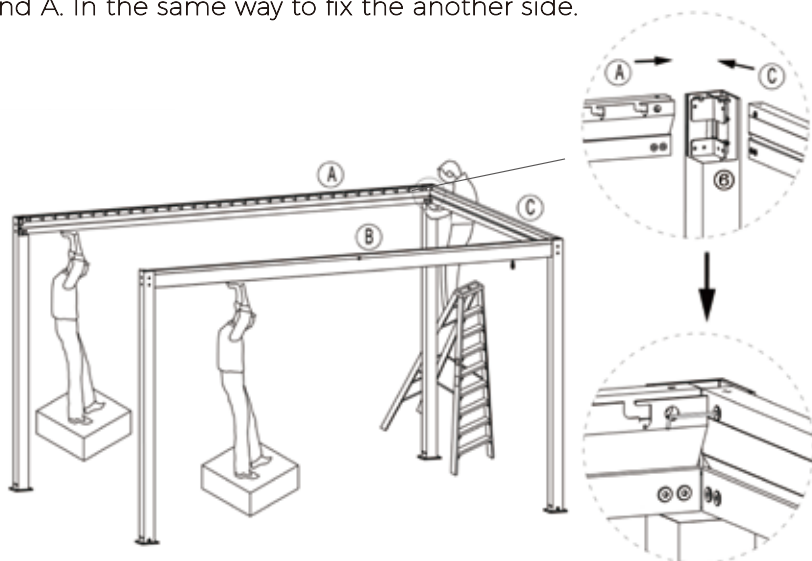

Mounting and usage

Step 3:

Install ③ beam as photo;

Loosen the ⑥ original screws. In the same way to fix the corresponding position.

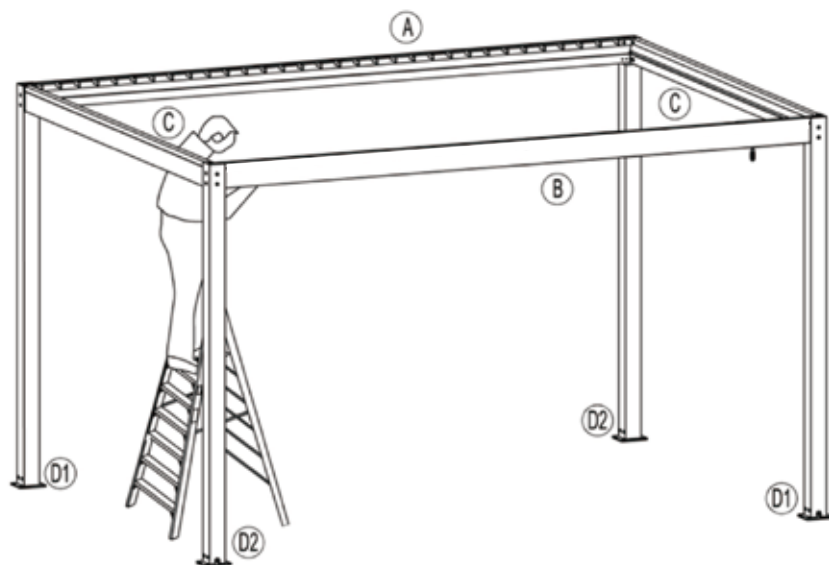
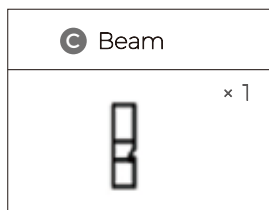

Step 4:

Install ④ post up plate as photo;

Fix ⑥ in the corresponding position;

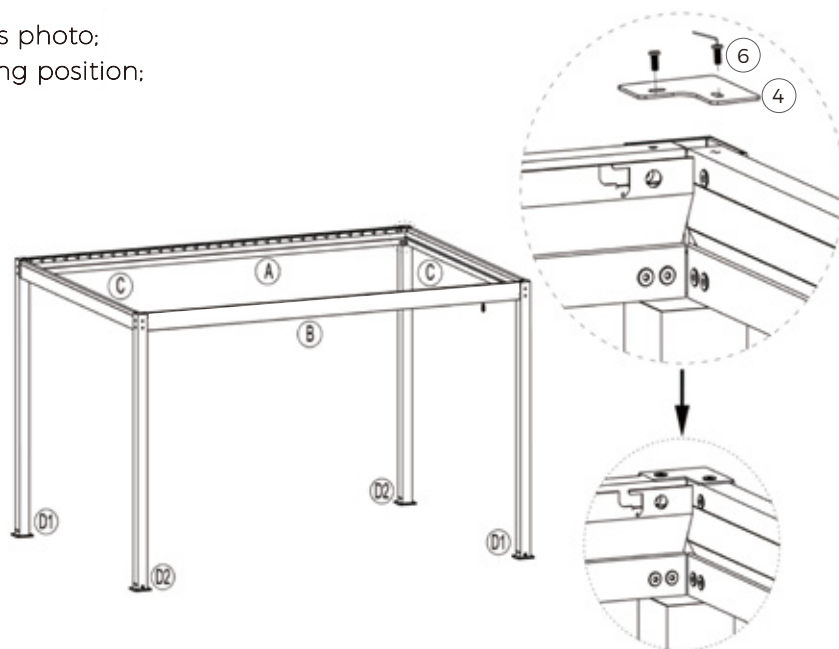
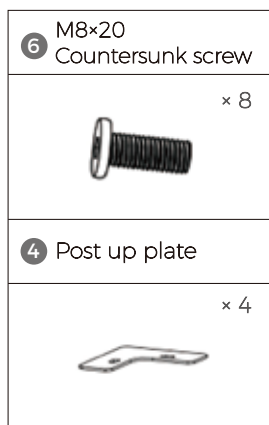

Mounting and usage

Step 5:

Install the ⑪ gutter connector gutters;

Install ⑫ connector for the gutter connector which plate wires;

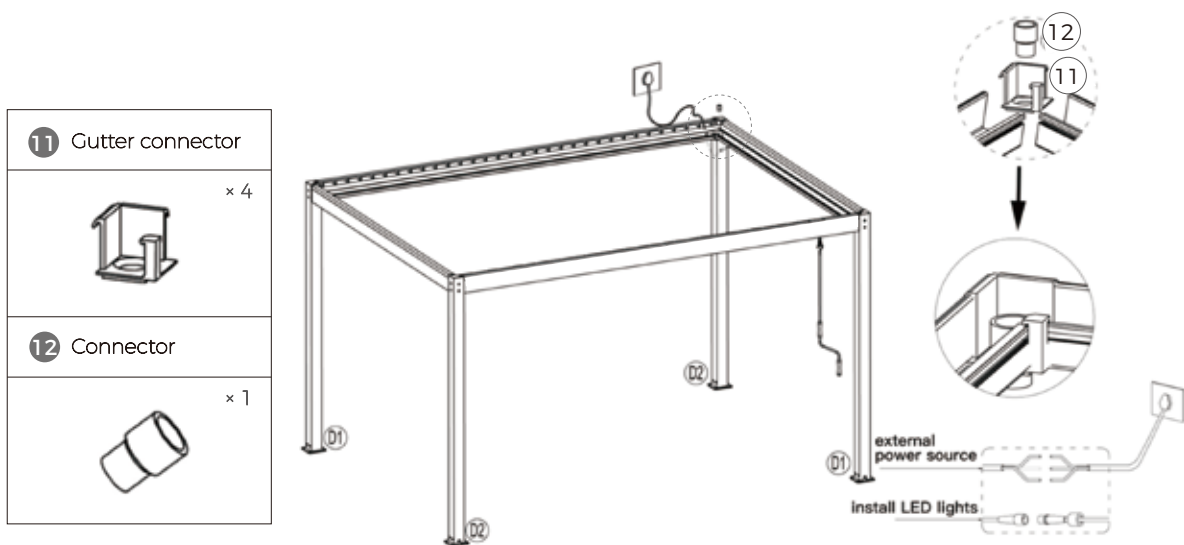

Step 6:

Install ⑬, ⑭ gutter as photo:

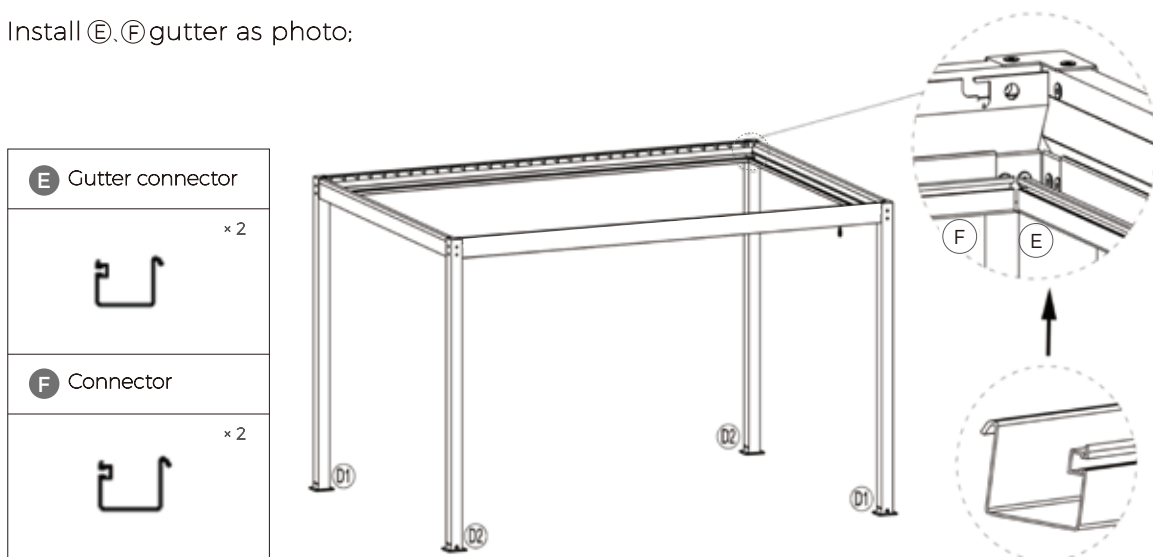

Mounting and usage

Step 7:

Install ⑥.⑨.① louver as photo;

Place ⑨ centre louver with ⑩ strength pivot pin and secure & tighten both side ⑤ M10 screw cap;

Place ① driving louver in line with the gear box with ⑭ drive shaft;

The square fixing at the end of driving louver goes into the gear box;

Fit all ⑥ common louver into the remaining slots in the beams;

⑩ Strength pivot pin × 2	⑤ M10 screw cap × 2
⑭ Drive shaft × 1	⑥ Centre louver × 30
⑨ Centre louver × 1	① Driving louver × 1

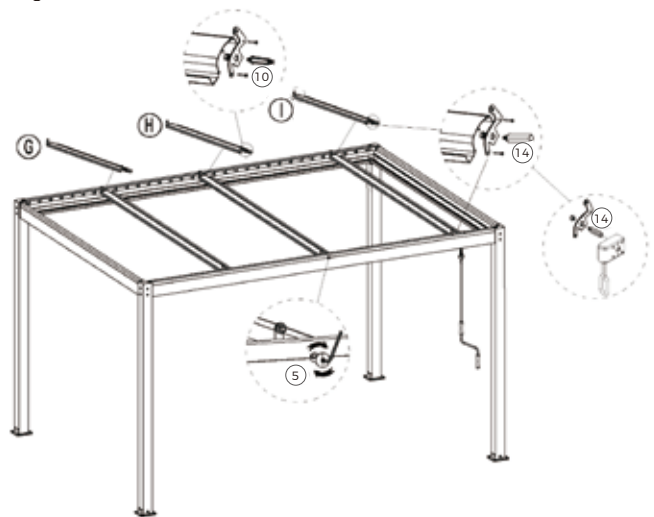

Remarks:

The 12th louver fix with ⑤ M10 screw cap (size 300×300cm)

The 16th louver fix with ⑤ M1 screw cap (size 300×400cm/ 400×400cm)

Step 8:

Install ⑦.⑧.⑨ on ⑪ control rod as following photo;

Note: Do not over tighten, finger tight is adequate.

Over tightening will prevent louvers from moving;

⑦ M8×20 HEX half tooth bolt × 64
⑧ DAP25 Plastic spacer × 64
⑨ M8 Locking nut × 64
⑪ Control rod × 2

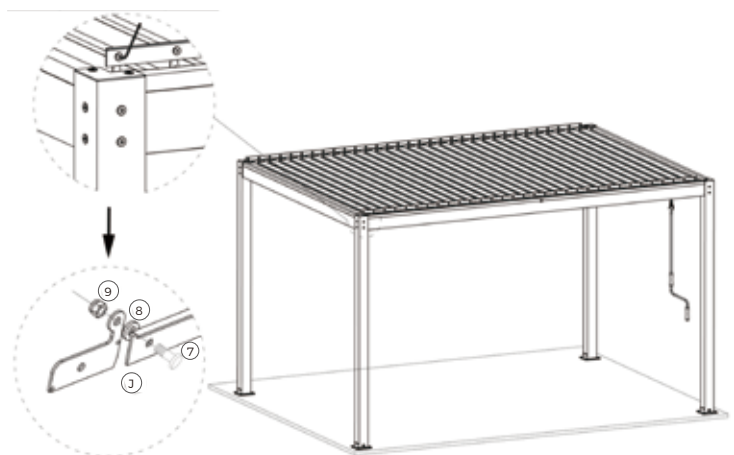

Mounting and usage

Step 9:

Make holes for expansion bolts X 4 per post;

Note: Drill size required is 12mm;

Insert bolts: Use a hammer drill if required;

Place posts over bolts;

Tighten nuts;

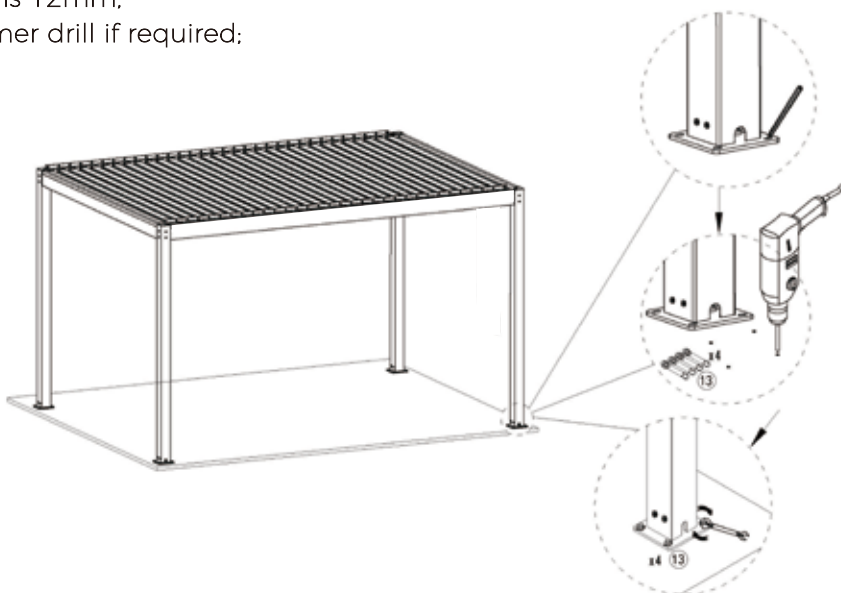
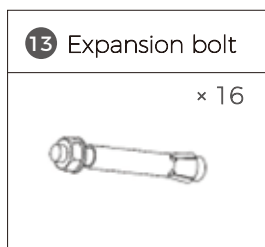

Congratulations, it has been successfully installed!

WARNING: Ensure louvers are open during periods of mild to strong winds.

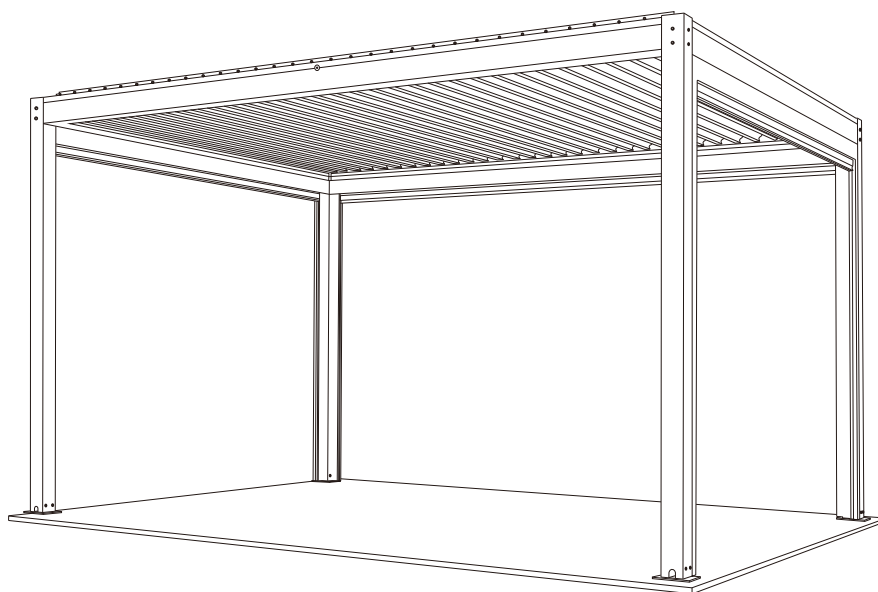

Dismounting

If you want to disassemble the Pergola, please follow the following process.

Attention! At least two people are needed for this step.

- ◆ Keep the Pergola louvers open before you begin with dismounting. Bind the Louvers of the Pergola together to avoid unintended unfolding. This might cause damage and injury. You can use the protection band that was fixed on the Pergola when purchasing it.
- ◆ Follow the mounting instructions in reversed order to dismount the Pergola.
- ◆ Make sure that drilling holes in the wall will be sealed professional.
- ◆ Attention! Safety hints and instructions have to be followed for dismounting as well.

Storage:

When you do not want to use the Pergola for a longer period of time it is recommended to take the Pergola out of the brackets and store it.

- ◆ Make sure that the frame is dry completely before storing.
- ◆ Store the Pergola at a dry and safe place that is not reachable for children.

Disposal:

Do not dispose this Pergola with other household wastes. To prevent possible harm to the environment or human health from uncontrolled waste disposal, recycle it responsibly to promote the sustainable reuse of material resources. To return your used device, please use the return and collection systems or contact the retailer where the product was purchased. They can take this product for environmental safe recycling. Dispose packing materials according to local guidelines.

SKYPERGS LITE

SMP-SPL-IN/EX-LED-33/34/364/44

Abmessungen:

3×3/3×4/3.6×4/4×4M

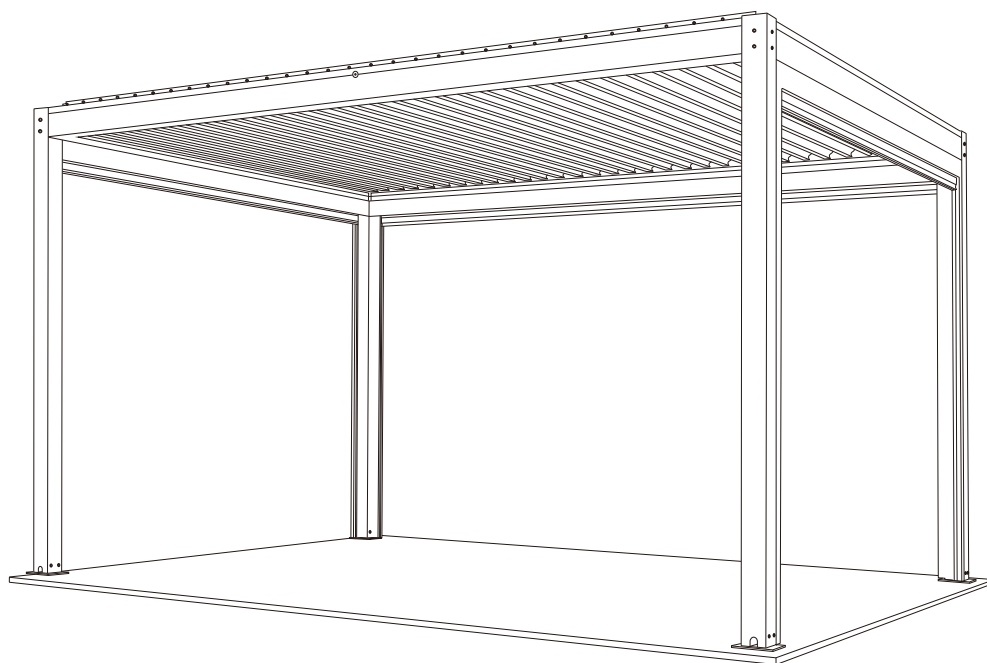

BEDIENUNGSANLEITUNG
UND SICHERHEITSHINWEISE



Installationsvideo

Inhalt









Werkzeuge und Personal.....	18
Teileliste	19
Produktbeschreibung und Sicherheitsanweisungen.....	23
Anbringung und Verwendung.....	25
Demontage.....	30

Werkzeuge und Personal

Liebe Damen und Herren

Herzlichen Glückwunsch und vielen Dank, dass Sie sich für den Kauf der SKYpergs Lite Pergola aus unserem Unternehmen entschieden haben. Damit Sie lange Freude an diesem Produkt haben und zu Ihrer eigenen und der Sicherheit anderer Personen, bitten wir Sie, die Anweisungen für den Zusammenbau zu befolgen. Bevor Sie mit dem Zusammenbau und der anschließenden Verwendung der Pergola beginnen, schlagen wir Ihnen vor, sich mit diesem Produkt vertraut zu machen. Stellen Sie sicher, dass alle Teile, die in den nachfolgenden Packlisten aufgeführt sind, vorhanden und unbeschädigt sind. Sollten Sie feststellen, dass Teile fehlen oder beschädigt sind, installieren Sie die Pergola bitte nicht, sondern setzen Sie sich umgehend mit uns in Verbindung. Beginnen Sie den Zusammenbau nicht, wenn Teile fehlen oder beschädigt sind.

Zusätzliches Werkzeug

a LEITER  >1.5M x2 13MM	b M10/ 13 MAULSCHLÜSSEL MITGELIEFERT  16MM	c GUMMIHAMMER 	d MESSBAND 
e 5 MM INBUSSCHLÜSSEL MITGELIEFERT 	f BLEISTIFT 	g WASSERWAAGE 	h ELEKTRO- BOHRMASCHINE 

Empfohlen: Mindestens 4 Personen

Normalerweise empfehlen wir, dass die Pergola von mindestens vier Personen (qualifizierte Techniker / autorisierte Installateure) zusammengesetzt werden muss.



Teilleiste

Größe: 300X300CM











TEILELISTE, Beschläge und sonstige Teile:

① M8×20 Senkschraube  × 16	② Handkurbel  × 1	③ Grundplatte  × 4
④ Pfostenplatte  × 4	⑤ M10 Schraubkappen  × 2	⑥ M8×20 HEX-Maschinenbolzen  × 8
⑦ M8×20 HEX Halbgewindebolzen  × 46	⑧ DAP25 Kunststoff-Abstandshalter  × 46	⑨ M8 Sperrmutter  × 46
⑩ Festigkeit Drehzapfen  × 2	⑪ Rinnenverbinder  × 4	⑫ Verbinder  × 1
⑬ Expansionsbolzen  × 16	⑭ Antriebswelle  × 1	

Teilleiste

Größe: 300X300CM

Liste der Teile des Aluminiumprofils:

<p>Ⓐ Träger mit Gelenkbuchse</p>	<p>Ⓑ Träger mit Ritzel und Gelenkbuchse</p>
 <p>× 1</p>	 <p>× 1</p>
<p>Ⓒ Träger</p>	<p>Ⓓ1 Pfosten+Pfostenverbinder</p>
 <p>× 2</p>	 <p>× 2</p>
<p>Ⓓ2 Pfosten+Pfostenverbinder</p>	<p>Ⓔ Kurze Rinne</p>
 <p>× 2</p>	 <p>× 2</p>
<p>Ⓕ Lange Rinne</p>	<p>Ⓖ Allgemein lauter</p>
 <p>× 2</p>	 <p>× 21</p>
<p>Ⓖ Mittlere Jalousie</p>	<p>Ⓙ Antriebsjalousie</p>
 <p>× 1</p>	 <p>× 1</p>
<p>Ⓙ Steuerstange</p>	
 <p>× 2</p>	

Teilleiste











Größe: 300X400CM/360X400CM/400X400CM
TEILELISTE, Beschläge und sonstige Teile:

① M8×20 Senkschraube  × 16	② Handkurbel  × 1	③ Grundplatte  × 4
④ Pfostenplatte  × 4	⑤ M10 Schraubkappen  × 2	⑥ M8×20 HEX-Maschinenbolzen  × 8
⑦ M8×20 HEX Halbgewindebolzen  × 64	⑧ DAP25 Kunststoff-Abstandshalter  × 64	⑨ M8 Sperrmutter  × 64
⑩ Festigkeit Drehzapfen  × 2	⑪ Rinnenverbinder  × 4	⑫ Verbinder  × 1
⑬ Expansionsbolzen  × 16	⑭ Antriebswelle  × 1	

Teileliste

Größe: 300X400CM/360X400CM/400X400CM

Liste der Teile des Aluminiumprofils:

<p>Ⓐ Träger mit Gelenkbuchse</p>	<p>Ⓑ Träger mit Ritzel und Gelenkbuchse</p>
 <p>x 1</p>	 <p>x 1</p>
<p>Ⓒ Träger</p>	<p>Ⓓ1 Pfosten+Pfostenverbinder</p>
 <p>x 2</p>	 <p>x 2</p>
<p>Ⓓ2 Pfosten+Pfostenverbinder</p>	<p>Ⓔ Kurze Rinne</p>
 <p>x 2</p>	 <p>x 2</p>
<p>Ⓕ Lange Rinne</p>	<p>Ⓒ Allgemein lauter</p>
 <p>x 2</p>	 <p>x 31</p>
<p>Ⓖ Mittlere Jalousie</p>	<p>Ⓖ Antriebsjalousie</p>
 <p>x 1</p>	 <p>x 1</p>
<p>Ⓙ Steuerstange</p>	
 <p>x 2</p>	

Produktbeschreibung und Sicherheitsanweisungen

Beschreibung:

Machen Sie das Beste aus Ihrem Außenbereich mit Ihrer Pergola. Entspannen Sie sich und genießen Sie den Außenbereich, während Sie vor der Sonne geschützt sind. Die Pergola mit beschichtetem Aluminiumrahmen eignet sich perfekt für die Beschattung Ihres Gartens, Ihrer Terrasse, Ihres Innenhofs oder eines beliebigen Patios.

Symbolerklärung:

 Dieses Warndreieck macht auf Gefahren aufmerksam, die zum Tod oder zu schweren Verletzungen führen können oder die für die Funktion der Pergola wichtig sind.

 Dieses Zeichen kennzeichnet wichtige Hinweise.

Sicherheitsanweisung:

Warnung: Für Ihre Sicherheit und die Sicherheit anderer Personen ist es wichtig, dass Sie die folgenden Anweisungen befolgen und die Warnhinweise beachten

 Um diese Pergola zu installieren, sind technische Kenntnisse erforderlich. Bringen Sie diese Pergola nicht selbst an, sondern wenden Sie sich an einen Fachmann, wenn Sie Hilfe benötigen.

- ◆ Dass sie sich nicht sicher sind, ob die Pergola an dem von Ihnen für die Installation gewählten Platz angebracht werden kann.
- ◆ Dass sie die Gebrauchsanleitung oder Teile davon nicht verstehen.
- ◆ Dass sie nicht über die notwendigen Werkzeuge verfügen.
- ◆ Dass sie nicht über die notwendigen Fachkenntnisse verfügen.

 Aufgrund der Größe und des Gewichts des Produkts sind mindestens vier Personen erforderlich, um die Pergola zu bewegen und zu installieren. Versuchen Sie nicht, die Pergola allein zu installieren. Wenn die Pergola herunterfällt, kann es zu schweren Verletzungen und Sachschäden kommen! Wenden Sie sich an einen autorisierten Monteur.

 Installieren Sie die Pergola nicht, wenn Sie feststellen, dass Teile beschädigt sind oder fehlen. Wenden Sie sich an Ihren Fachhändler.

 Halten Sie Kinder und Haustiere während des Zusammenbaus und Anpassens vom Arbeitsbereich fern.

Produktbeschreibung und Sicherheitsanweisungen

- ⚠ Dieses Produkt und seine Befestigungsteile sind nur für die Installation an einer glatten Zementwand oder einem stabilen Mauerwerk geeignet. Wenn die Wand/ das Mauerwerk Risse aufweist, müssen Sie einen Fachmann hinzuziehen.
- ⚠ Ohne Genehmigung des Herstellers oder eines autorisierten Vertreters dürfen keine Veränderungen an der Konstruktion oder am Aufbau des Produkts vorgenommen werden.
- 👉 Achten Sie beim Zusammenbau darauf, dass Ihre Hände sauber sind, um Verschmutzungen am Rahmen zu vermeiden.
- ⚠ Niemand darf auf die Pergola klettern. Es ist verboten, etwas in die Pergola zu hängen.





Zum Schutz des Anstrichs wurde eine Plane verwendet. Diese muss anschließend entfernt werden. Diese Struktur ist nicht dauerhaft und die Gewährleistung deckt keine Schäden ab, die durch extreme Witterungsbedingungen wie starkem Regen, starkem Wind oder bei starker Erwärmung durch Heizgeräte oder Grillen entstehen.

Sicherheitsmaßnahmen sollten beim Zusammenbau und der Verwendung dieses Produkts immer befolgt werden, um das Risiko von Verletzungen und Schäden an der Ausrüstung zu verringern. Bitte lesen Sie alle Anweisungen vor dem Zusammenbau und der Verwendung. Lassen Sie Kinder niemals unbeaufsichtigt in der Nähe/ unter dieser Pergola. Versuchen Sie nicht, die Pergola bei mäßigem oder schwerem Wind zusammenzubauen oder zu verwenden. Lassen Sie die Jalousie der Pergola immer offen und sichern Sie sie bei schwerem Wind oder extremen Wetterbedingungen, um Schäden an der Pergola oder Verletzungen von Personen zu vermeiden.

Anbringung und Verwendung

Schritt 1:

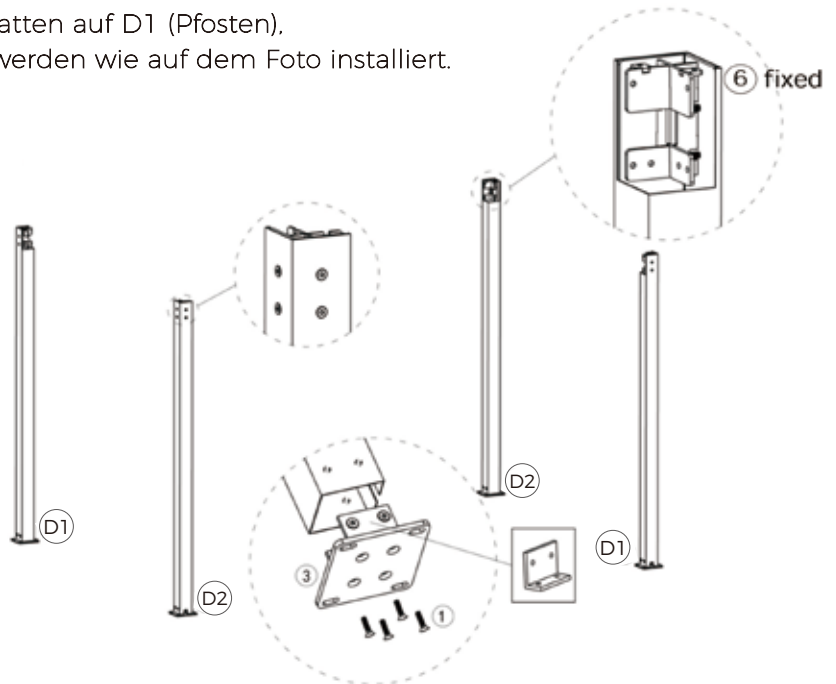

Installieren Sie ③ Grundplatten auf D1 (Pfosten), D2 (Pfosten); Vier Pfosten werden wie auf dem Foto installiert.

① M8x20 Senkschraube	
	× 16
③ Grundplatte	
	× 4
D1 Pfosten+Pfostenverbinder	
	× 2
D2 Pfosten+Pfostenverbinder	
	× 2



Schritt 2:

Installieren Sie ①, ②, ③ Träger wie auf dem Foto gezeigt; Lösen Sie die ⑥ Originalschrauben, verbinden Sie D1 (Pfosten) und A, verbinden Sie auf die gleiche Weise D2 (Pfosten) und A. Befestigen Sie die andere Seite auf die gleiche Weise.

① Träger mit Gelenkbuchse	
	× 1
② Träger mit Ritzel und Gelenkbuchse	
	× 1
③ Träger	
	× 1

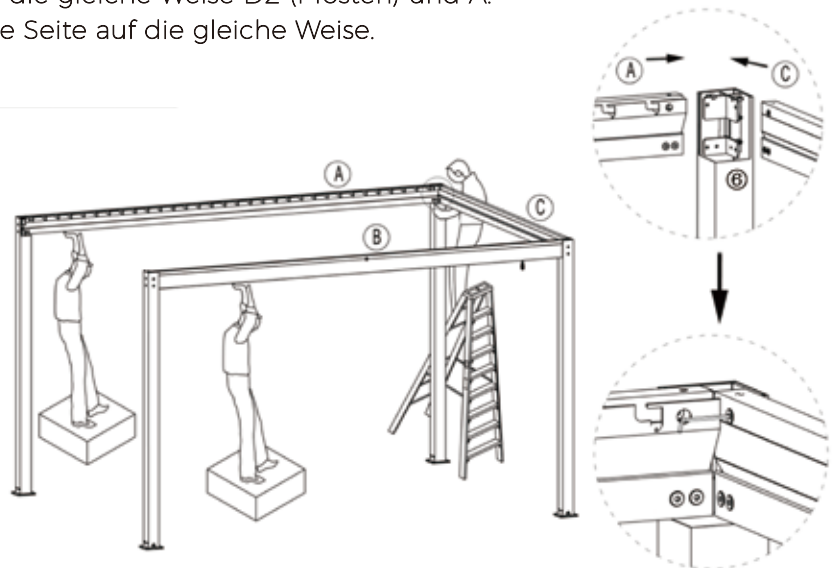

Anbringung und Verwendung

Schritt 3:

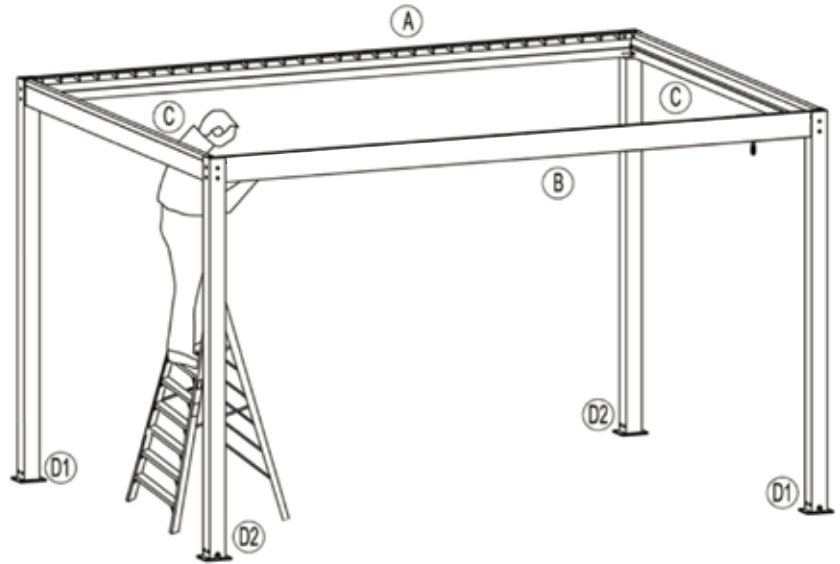

Installieren Sie den ③ Träger wie auf dem Foto gezeigt;
Lösen Sie die ⑥ Originalschrauben und befestigen Sie
die entsprechende Position auf die gleiche Weise;

③ Träger	
	× 1



Schritt 4:

Installieren Sie ④ Pfostenplatte nach oben wie auf dem Foto gezeigt;
Befestigen Sie ⑥ in der entsprechenden Position;

⑥ M8×20 HEX-Maschinenbolzen	
	× 8
④ Pfostenplatte	
	× 4

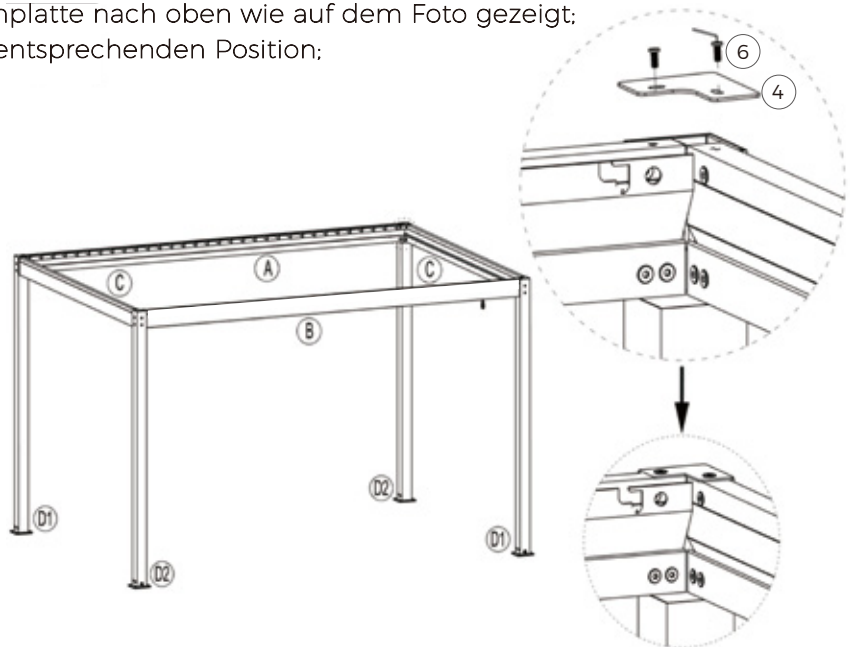



Anbringung und Verwendung

Schritt 5:

Installieren Sie die ⑪ Rinnenverbinder;

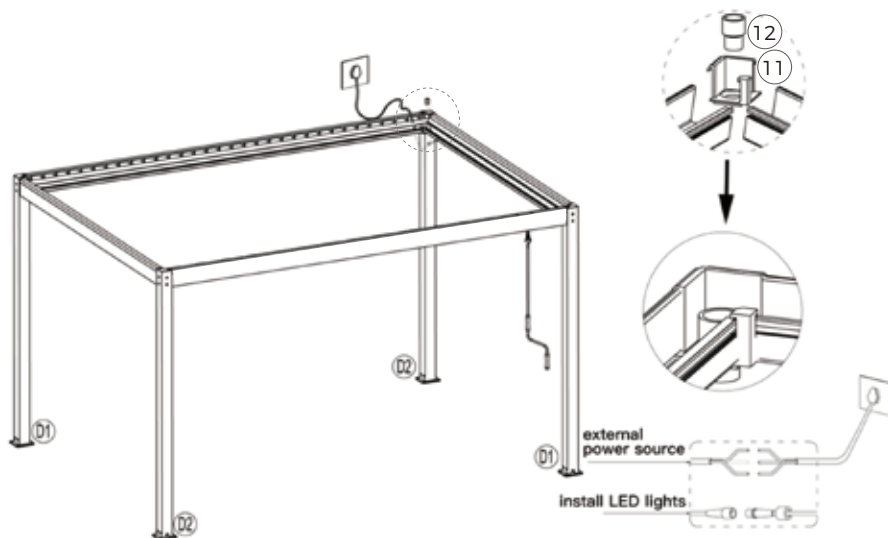

Installieren Sie ⑫ Verbinder für die Rinnenverbinder mit Plattendraht;

⑪ Rinnenverbinder	
	× 4
⑫ Verbinder	
	× 1



Schritt 6:

Installieren Sie die ⑤,⑥-Rinne wie auf dem Foto gezeigt;

⑤ Gutter connector	
	× 2
⑥ Connector	
	× 2

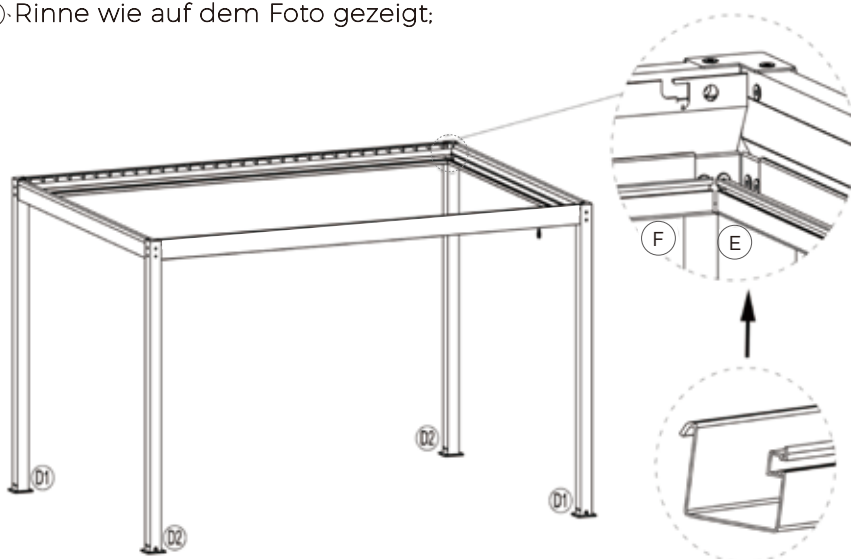

Anbringung und Verwendung

Schritt 7:

Installieren Sie die ⑥, ⑦, ⑧, ⑨, ⑩, ⑪, ⑫, ⑬, ⑭, ⑮, ⑯, ⑰, ⑱, ⑲, ⑳, ㉑, ㉒, ㉓, ㉔, ㉕, ㉖, ㉗, ㉘, ㉙, ㉚, ㉛, ㉜, ㉝, ㉞, ㉟, ㊱, ㊲, ㊳, ㊴, ㊵, ㊶, ㊷, ㊸, ㊹, ㊺, ㊻, ㊼, ㊽, ㊾, ㊿, 1, 2, 3, 4, 5, 6, 7, 8, 9, 10, 11, 12, 13, 14, 15, 16, 17, 18, 19, 20, 21, 22, 23, 24, 25, 26, 27, 28, 29, 30, 31, 32, 33, 34, 35, 36, 37, 38, 39, 40, 41, 42, 43, 44, 45, 46, 47, 48, 49, 50, 51, 52, 53, 54, 55, 56, 57, 58, 59, 60, 61, 62, 63, 64, 65, 66, 67, 68, 69, 70, 71, 72, 73, 74, 75, 76, 77, 78, 79, 80, 81, 82, 83, 84, 85, 86, 87, 88, 89, 90, 91, 92, 93, 94, 95, 96, 97, 98, 99, 100, 101, 102, 103, 104, 105, 106, 107, 108, 109, 110, 111, 112, 113, 114, 115, 116, 117, 118, 119, 120, 121, 122, 123, 124, 125, 126, 127, 128, 129, 130, 131, 132, 133, 134, 135, 136, 137, 138, 139, 140, 141, 142, 143, 144, 145, 146, 147, 148, 149, 150, 151, 152, 153, 154, 155, 156, 157, 158, 159, 160, 161, 162, 163, 164, 165, 166, 167, 168, 169, 170, 171, 172, 173, 174, 175, 176, 177, 178, 179, 180, 181, 182, 183, 184, 185, 186, 187, 188, 189, 190, 191, 192, 193, 194, 195, 196, 197, 198, 199, 200, 201, 202, 203, 204, 205, 206, 207, 208, 209, 210, 211, 212, 213, 214, 215, 216, 217, 218, 219, 220, 221, 222, 223, 224, 225, 226, 227, 228, 229, 230, 231, 232, 233, 234, 235, 236, 237, 238, 239, 240, 241, 242, 243, 244, 245, 246, 247, 248, 249, 250, 251, 252, 253, 254, 255, 256, 257, 258, 259, 260, 261, 262, 263, 264, 265, 266, 267, 268, 269, 270, 271, 272, 273, 274, 275, 276, 277, 278, 279, 280, 281, 282, 283, 284, 285, 286, 287, 288, 289, 290, 291, 292, 293, 294, 295, 296, 297, 298, 299, 300, 301, 302, 303, 304, 305, 306, 307, 308, 309, 310, 311, 312, 313, 314, 315, 316, 317, 318, 319, 320, 321, 322, 323, 324, 325, 326, 327, 328, 329, 330, 331, 332, 333, 334, 335, 336, 337, 338, 339, 340, 341, 342, 343, 344, 345, 346, 347, 348, 349, 350, 351, 352, 353, 354, 355, 356, 357, 358, 359, 360, 361, 362, 363, 364, 365, 366, 367, 368, 369, 370, 371, 372, 373, 374, 375, 376, 377, 378, 379, 380, 381, 382, 383, 384, 385, 386, 387, 388, 389, 390, 391, 392, 393, 394, 395, 396, 397, 398, 399, 400, 401, 402, 403, 404, 405, 406, 407, 408, 409, 410, 411, 412, 413, 414, 415, 416, 417, 418, 419, 420, 421, 422, 423, 424, 425, 426, 427, 428, 429, 430, 431, 432, 433, 434, 435, 436, 437, 438, 439, 440, 441, 442, 443, 444, 445, 446, 447, 448, 449, 450, 451, 452, 453, 454, 455, 456, 457, 458, 459, 460, 461, 462, 463, 464, 465, 466, 467, 468, 469, 470, 471, 472, 473, 474, 475, 476, 477, 478, 479, 480, 481, 482, 483, 484, 485, 486, 487, 488, 489, 490, 491, 492, 493, 494, 495, 496, 497, 498, 499, 500, 501, 502, 503, 504, 505, 506, 507, 508, 509, 510, 511, 512, 513, 514, 515, 516, 517, 518, 519, 520, 521, 522, 523, 524, 525, 526, 527, 528, 529, 530, 531, 532, 533, 534, 535, 536, 537, 538, 539, 540, 541, 542, 543, 544, 545, 546, 547, 548, 549, 550, 551, 552, 553, 554, 555, 556, 557, 558, 559, 560, 561, 562, 563, 564, 565, 566, 567, 568, 569, 570, 571, 572, 573, 574, 575, 576, 577, 578, 579, 580, 581, 582, 583, 584, 585, 586, 587, 588, 589, 590, 591, 592, 593, 594, 595, 596, 597, 598, 599, 600, 601, 602, 603, 604, 605, 606, 607, 608, 609, 610, 611, 612, 613, 614, 615, 616, 617, 618, 619, 620, 621, 622, 623, 624, 625, 626, 627, 628, 629, 630, 631, 632, 633, 634, 635, 636, 637, 638, 639, 640, 641, 642, 643, 644, 645, 646, 647, 648, 649, 650, 651, 652, 653, 654, 655, 656, 657, 658, 659, 660, 661, 662, 663, 664, 665, 666, 667, 668, 669, 670, 671, 672, 673, 674, 675, 676, 677, 678, 679, 680, 681, 682, 683, 684, 685, 686, 687, 688, 689, 690, 691, 692, 693, 694, 695, 696, 697, 698, 699, 700, 701, 702, 703, 704, 705, 706, 707, 708, 709, 710, 711, 712, 713, 714, 715, 716, 717, 718, 719, 720, 721, 722, 723, 724, 725, 726, 727, 728, 729, 730, 731, 732, 733, 734, 735, 736, 737, 738, 739, 740, 741, 742, 743, 744, 745, 746, 747, 748, 749, 750, 751, 752, 753, 754, 755, 756, 757, 758, 759, 760, 761, 762, 763, 764, 765, 766, 767, 768, 769, 770, 771, 772, 773, 774, 775, 776, 777, 778, 779, 780, 781, 782, 783, 784, 785, 786, 787, 788, 789, 790, 791, 792, 793, 794, 795, 796, 797, 798, 799, 800, 801, 802, 803, 804, 805, 806, 807, 808, 809, 810, 811, 812, 813, 814, 815, 816, 817, 818, 819, 820, 821, 822, 823, 824, 825, 826, 827, 828, 829, 830, 831, 832, 833, 834, 835, 836, 837, 838, 839, 840, 841, 842, 843, 844, 845, 846, 847, 848, 849, 850, 851, 852, 853, 854, 855, 856, 857, 858, 859, 860, 861, 862, 863, 864, 865, 866, 867, 868, 869, 870, 871, 872, 873, 874, 875, 876, 877, 878, 879, 880, 881, 882, 883, 884, 885, 886, 887, 888, 889, 890, 891, 892, 893, 894, 895, 896, 897, 898, 899, 900, 901, 902, 903, 904, 905, 906, 907, 908, 909, 910, 911, 912, 913, 914, 915, 916, 917, 918, 919, 920, 921, 922, 923, 924, 925, 926, 927, 928, 929, 930, 931, 932, 933, 934, 935, 936, 937, 938, 939, 940, 941, 942, 943, 944, 945, 946, 947, 948, 949, 950, 951, 952, 953, 954, 955, 956, 957, 958, 959, 960, 961, 962, 963, 964, 965, 966, 967, 968, 969, 970, 971, 972, 973, 974, 975, 976, 977, 978, 979, 980, 981, 982, 983, 984, 985, 986, 987, 988, 989, 990, 991, 992, 993, 994, 995, 996, 997, 998, 999, 1000.

⑩ Festigkeit Drehzapfen × 2	⑤ M10 Schraubkappen × 2
⑭ Antriebswelle × 1	④ Mittlere Jalousie × 21/30
⑨ Mittlere Jalousie × 1	① Antriebsjalousie × 1

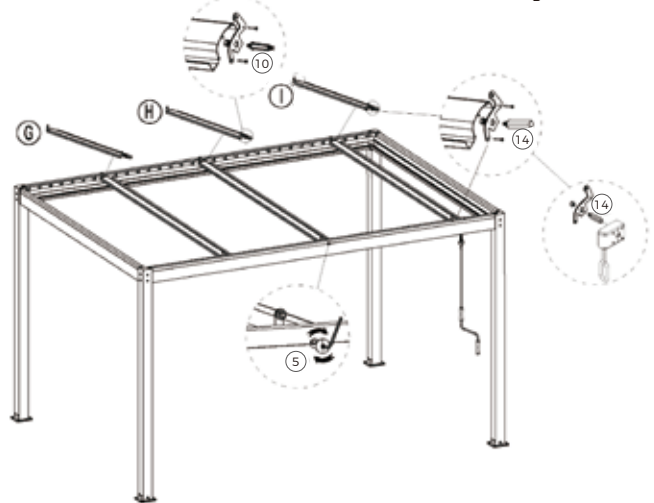

Remarks:

Die 12^{te} Jalousie wird mit ⑤ M10 Schraubkappen befestigt (Größe 300 × 300 cm)
Die 16^{te} Jalousie wird mit ⑤ M1 Schraubkappen befestigt (Größe 300 × 400 cm/ 400 × 400 cm)

Schritt 8:

Installieren Sie ⑦, ⑧, ⑨ an der ① -Steuerstange wie auf dem folgenden Foto gezeigt.
Hinweis: Ziehen Sie die Schrauben nicht übermäßig fest, ein leichtes Anziehen ist ausreichend. Ein übermäßiges Festziehen verhindert die Bewegung der Jalousien.

⑦ M8×20 HEX Halbgewindebolzen × 46/ 64	⑧ DAP25 Kunststoff-Abstandshalter × 46/ 64
⑨ M8 Sperrmutter × 46/ 64	① Steuerstange × 2

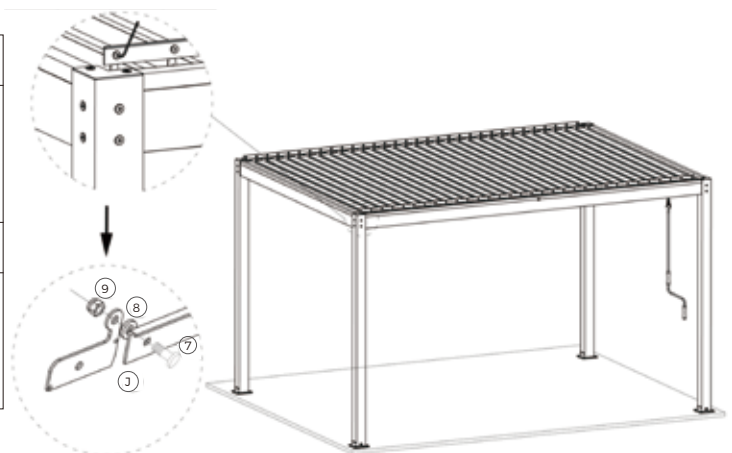

Anbringung und Verwendung

Schritt 9:

Bohren Sie Löcher für die Expansionsbolzen x 4 pro Pfosten;

Hinweis: Die erforderliche Bohrergröße ist 12 mm;

Stecken Sie die Bolzen ein: Verwenden Sie bei Bedarf einen Bohrhämmer;

Bringen Sie die Pfosten über den Bolzen an;

Ziehen Sie die Muttern fest;

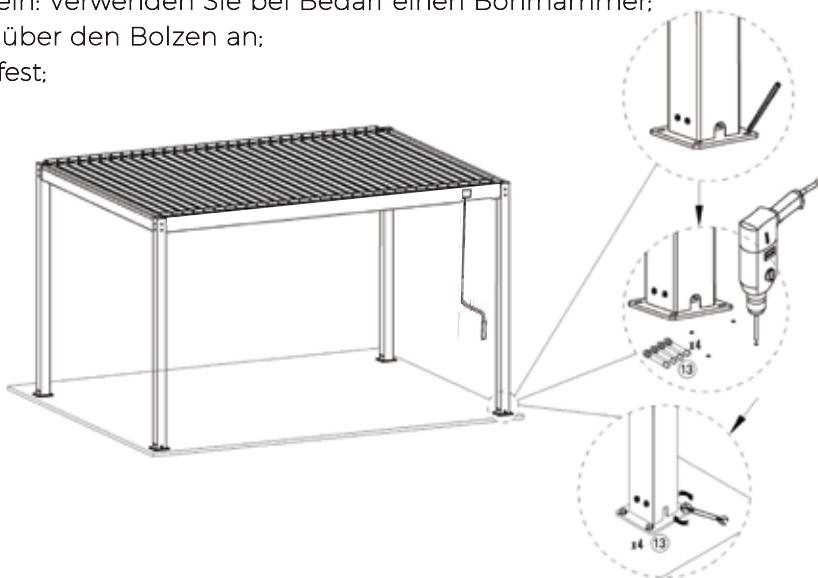
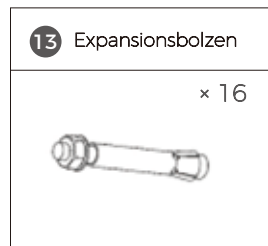

Herzlichen Glückwunsch, Sie haben die Installation erfolgreich abgeschlossen!

WARNUNG: Stellen Sie sicher, dass die Jalousien bei leichtem bis starkem Wind geöffnet sind.

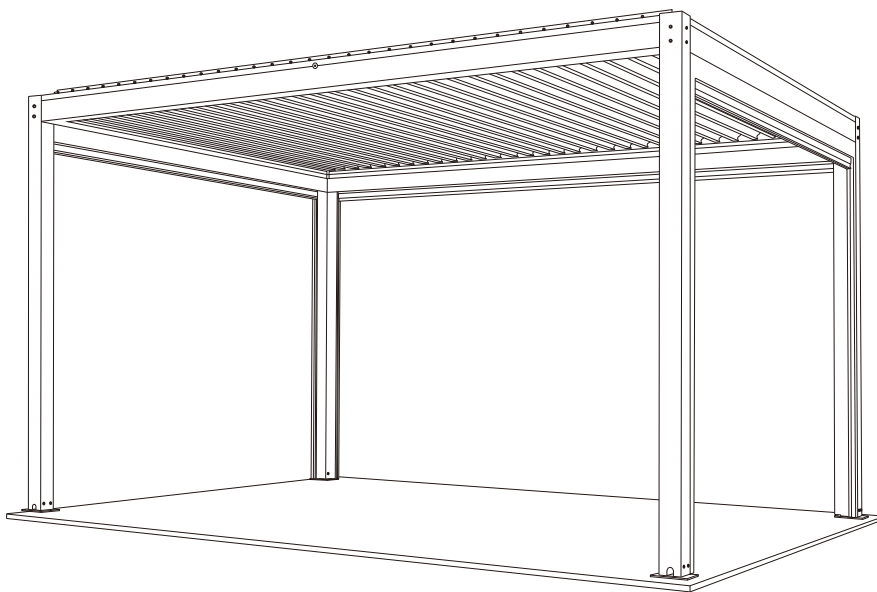

Demontage

Wenn Sie die Pergola demontieren wollen, gehen Sie bitte wie folgt vor.
Achtung! Für diesen Schritt sind mindestens zwei Personen erforderlich.

- ◆ Lassen Sie die Jalousien der Pergola offen, bevor Sie mit der Demontage beginnen. Binden Sie die Jalousien der Pergola zusammen, um ein unbeabsichtigtes Öffnen zu vermeiden. Dies könnte zu Schäden und Verletzungen führen. Sie können die Schutzbänder verwenden, die beim Kauf an der Pergola angebracht waren.
- ◆ Befolgen Sie die Anweisungen zur Anbringung in umgekehrter Reihenfolge, um die Pergola zu demontieren.
- ◆ Stellen Sie sicher, dass die Bohrlöcher in der Wand fachmännisch abgedichtet werden.
- ◆ Achtung! Auch bei der Demontage sind die Sicherheitshinweise und Anweisungen zu beachten.

Lagerung:

Wenn Sie die Pergola längere Zeit nicht verwenden wollen, empfiehlt es sich, die Pergola aus den Halterungen zu nehmen und zu lagern.

- ◆ Stellen Sie sicher, dass der Rahmen vollständig trocken ist, bevor Sie ihn lagern.
- ◆ Lagern Sie die Pergola an einem trockenen und sicheren Ort, der für Kinder unzugänglich ist.

Entsorgung:

Entsorgen Sie diese Pergola nicht über den Hausmüll. Um mögliche Schäden für die Umwelt oder die menschliche Gesundheit durch unkontrollierte Entsorgung zu vermeiden, recyceln Sie es verantwortungsvoll, um die nachhaltige Wiederverwendung von Materialressourcen zu fördern.

Um Ihr Altgerät zurückzugeben, verwenden Sie bitte die Rückgabe- und Sammelsysteme oder wenden Sie sich an den Händler, bei dem Sie das Produkt gekauft haben. Sie können dieses Produkt dem umweltgerechten und sicheren Recycling zuführen. Entsorgen Sie das Verpackungsmaterial gemäß den örtlichen Richtlinien.

SiMPO
L I F E S T Y L E

sales@simpo.eu

www.simpo.eu

www.simpoliving.com

