

# Assembly Instructions

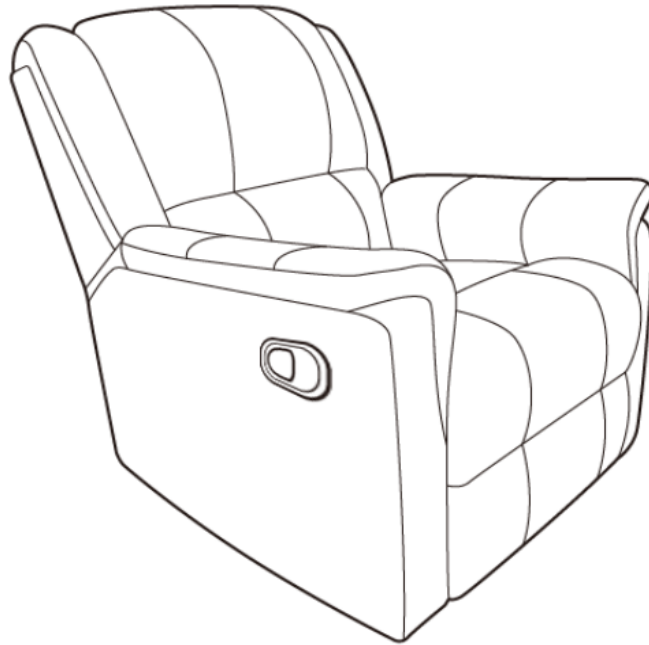

Caution: You must read this before you proceed

## Glider Recliner with Swivel

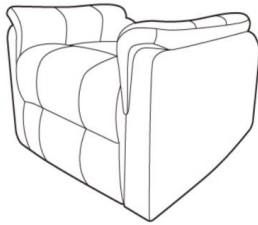
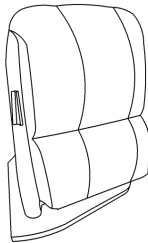

### Part List

Label	Picture	Description	QTY
A		Chair Base	1
B		Chair Backrest	1

C		Left Wing	1
D		Right Wing	1

## Assembly Preparation

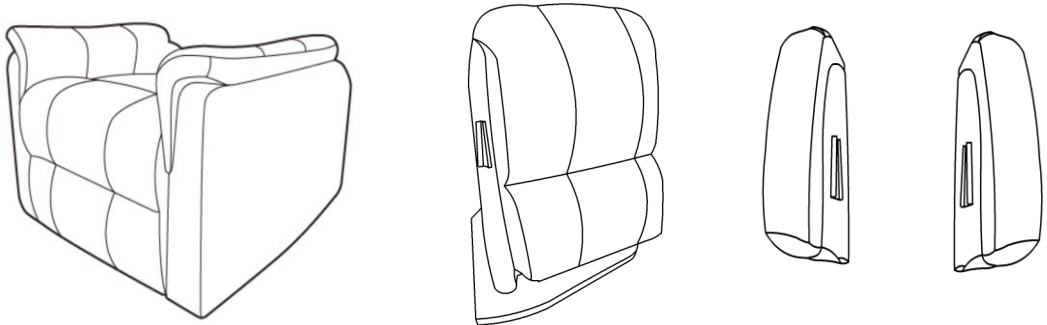
<p>Before Beginning Assembly:</p>	
---	---



- Read instructions, cover to cover-



- Have 2 adults on hand for assembly-



- Do not assemble on flooring or carpet-



- Assemble on a clean non-marring surface (packing foam)-



- Save all packaging until finished-

# Assembly Steps

## Overview

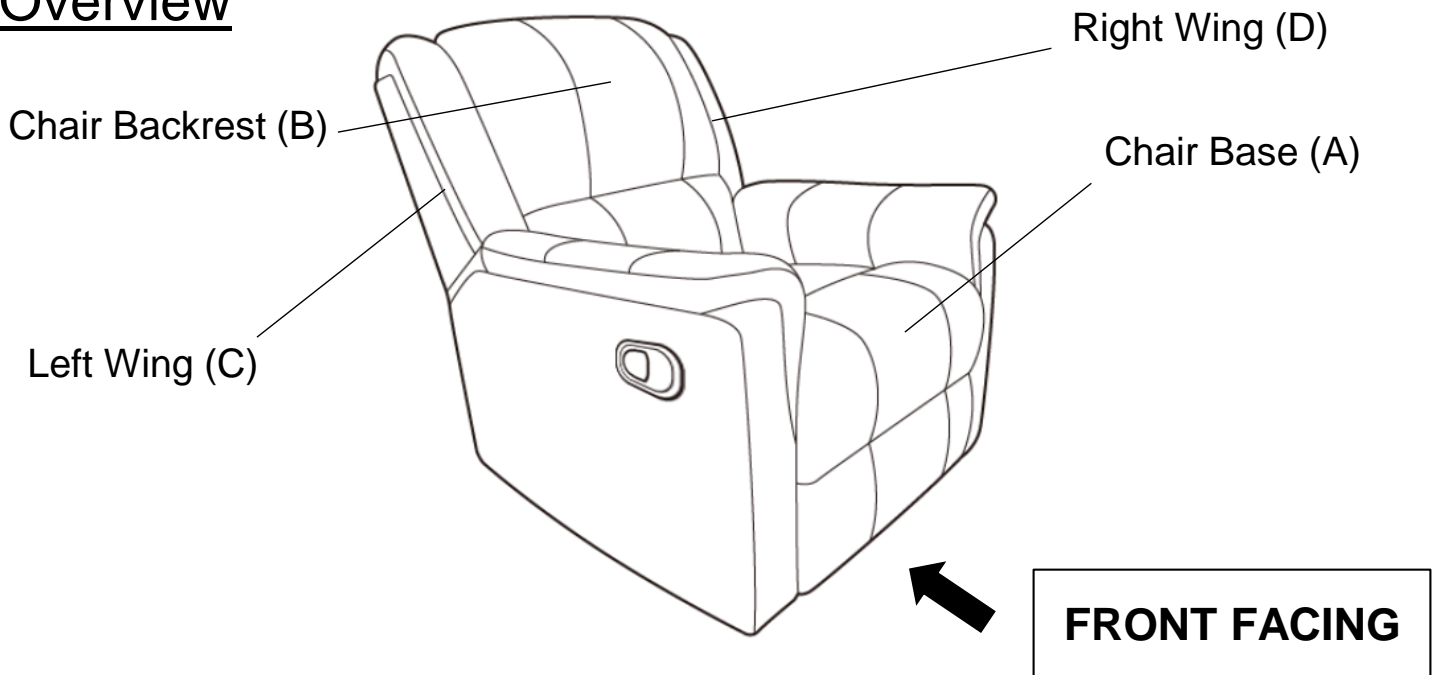

This Recliner Chair has multiple parts and may require about 30 minutes to assemble. To give you an overview of the Recliner Chair parts, the above picture is to help you put the various parts into perspective. Please read through the instructions below to familiarise yourself with the parts and steps before assembly.

## Step 1

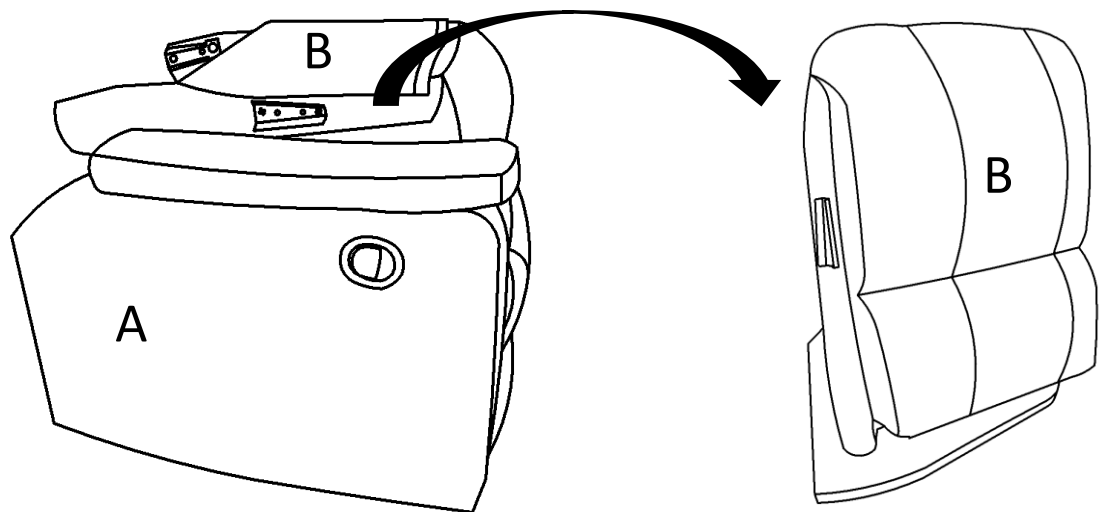

Take the Chair Backrest(B) out from Chair Base(A).  
Place the Chair Base(A) facedown on a clean, non-marring surface.

## Step 2

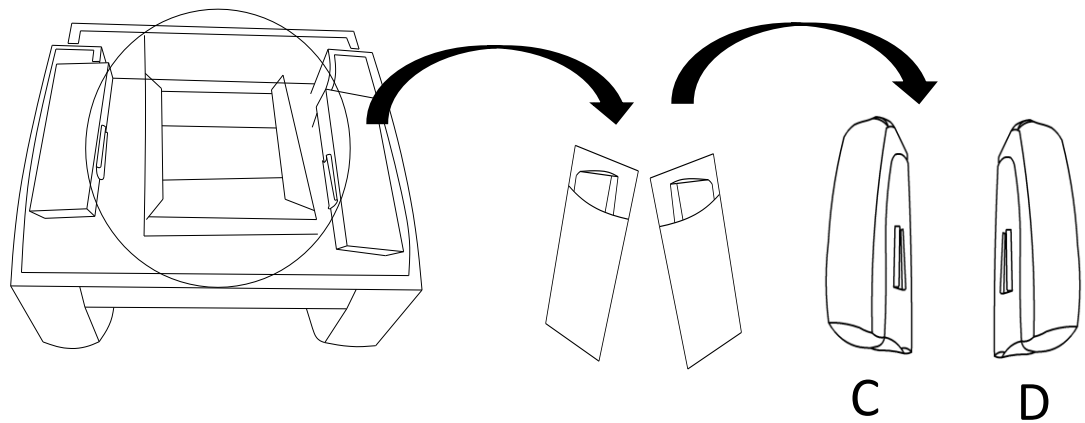

Take out the non-woven bags from the bottom of Chair Base(A) and open the non-woven bags to take out the Left Wing(C) and Right Wing(D).

## Step 3

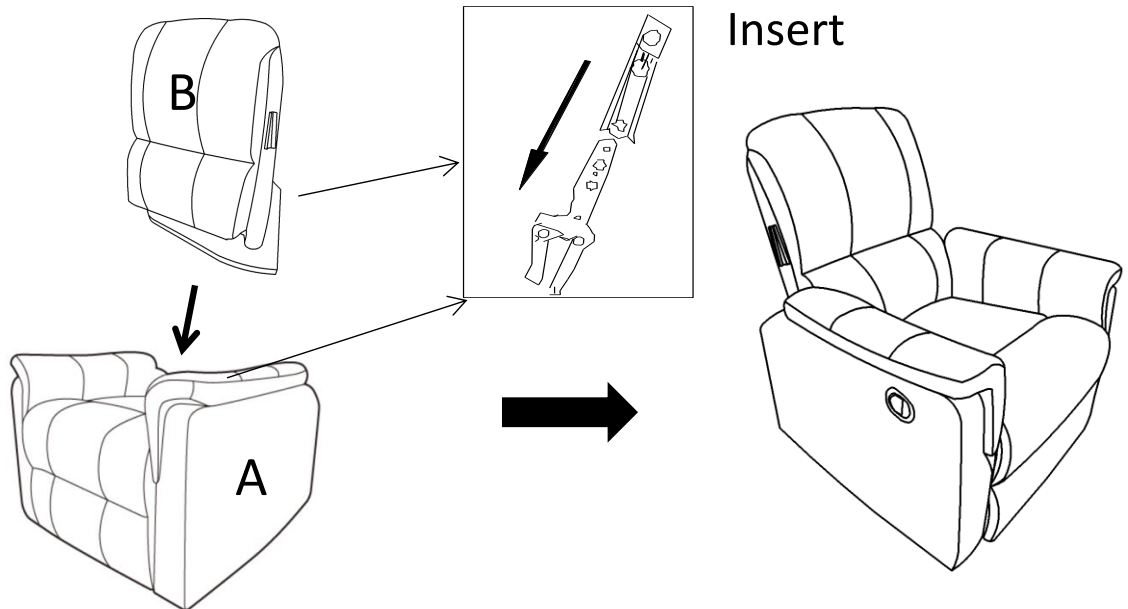

With assistance from your adult partner, hold up the Chair Backrest(B), and stand behind the Chair Base(A).

Insert the small metal arms on the sides of the Chair Backrest(B) into the prefabricated slide lock gadget on the Chair Base(A) as shown above.

Firmly but gently, push the Backrest downwards until it is fully slotted and locked into position.

## Step 4

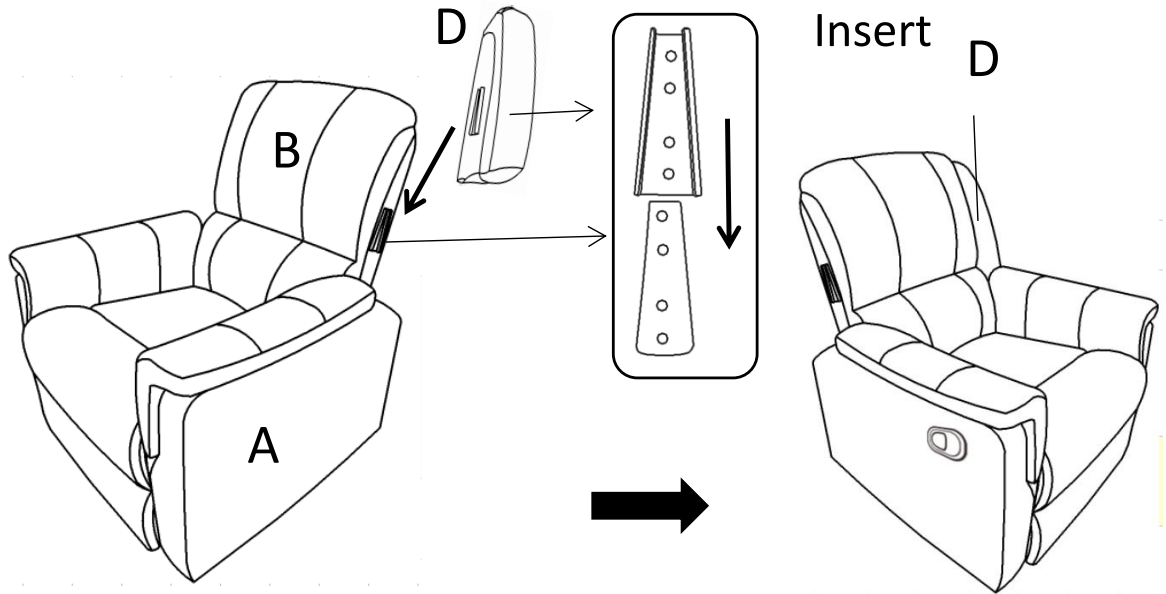

Align the mounting brackets of the Right Wing(D) with those on the right side of Chair Backrest(B).  
Then slide mounting brackets together until they lock into position as shown above.

## Step 5

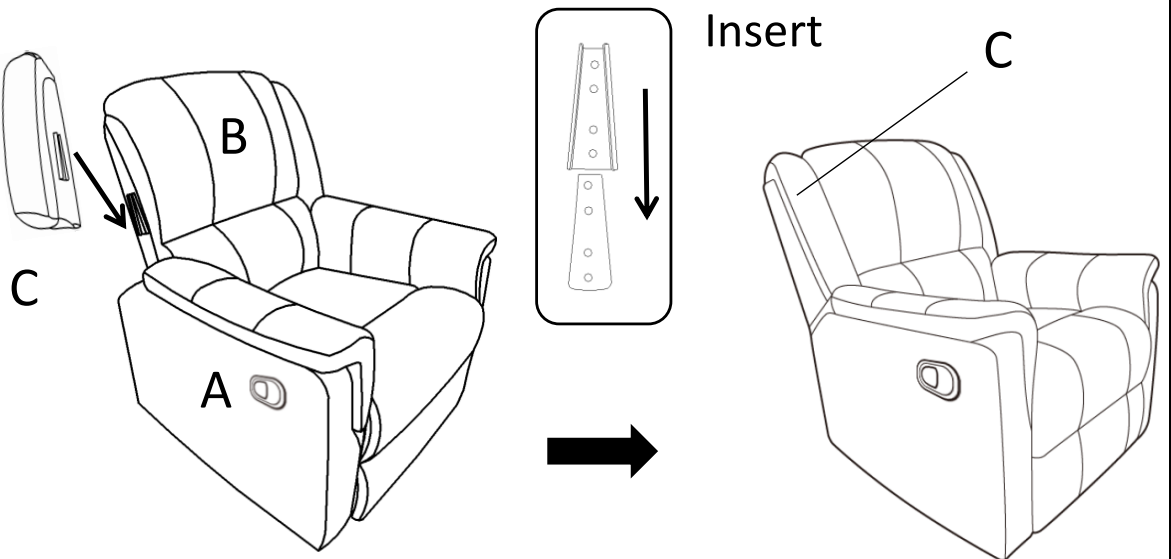

Repeat the same process to align the Left Wing(C) with those on the Left side of Chair Backrest(B).

## Step 6

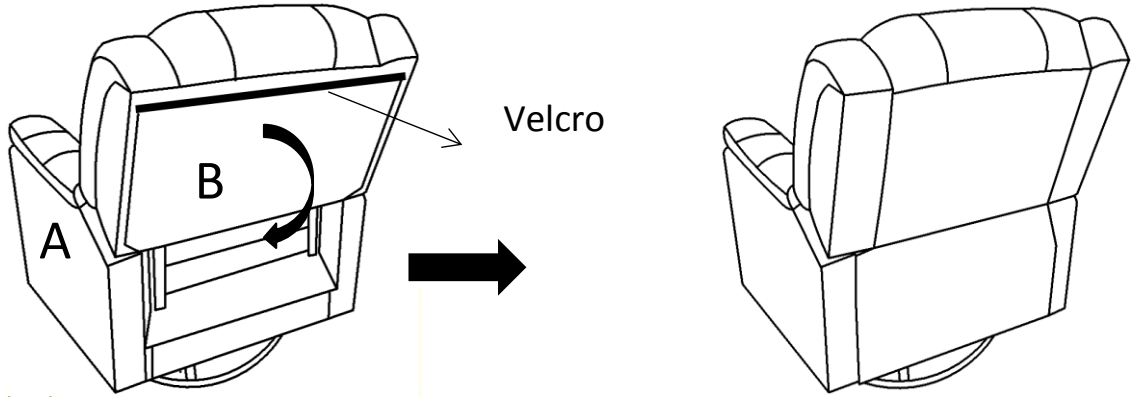

Smooth down the fabric flap on the Chair Backrest(B).  
Run your hands down both sides of the flap, from top to bottom, allowing the velcro tape to adhere to the flap under the seat of the Recliner Chair.

## Step 7

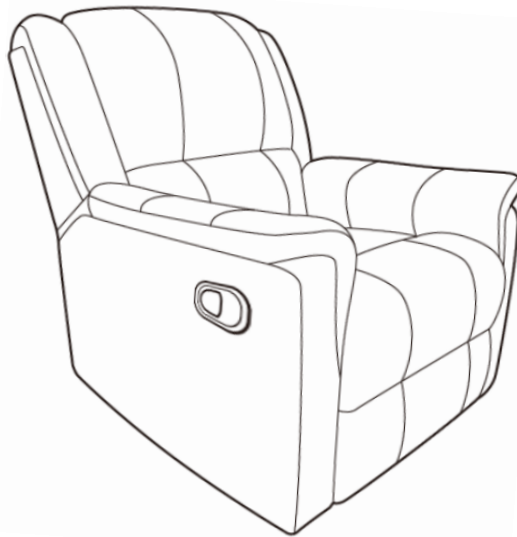

Make sure all parts are connected and securely locked into position.  
Your Recliner Chair is ready for use.

**This Recliner Chair can only be used on a flat, level surface.**

# Disassembly Instructions

## Step 8

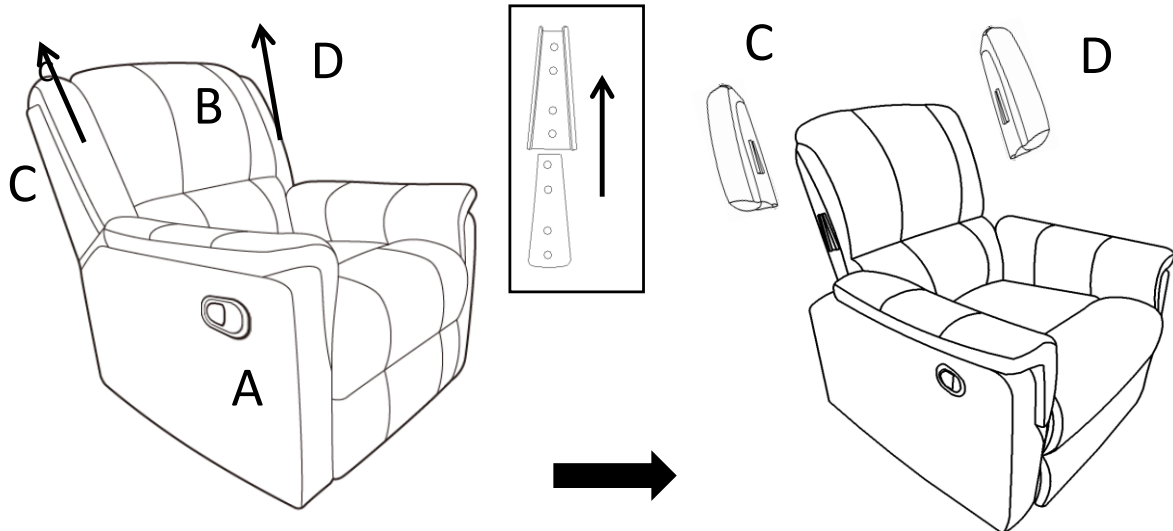

Pull up on the Right Wing(D) and the Left Wing(C) one by one until to be taken off from the Backrest(B) as pictured .

## Step 9

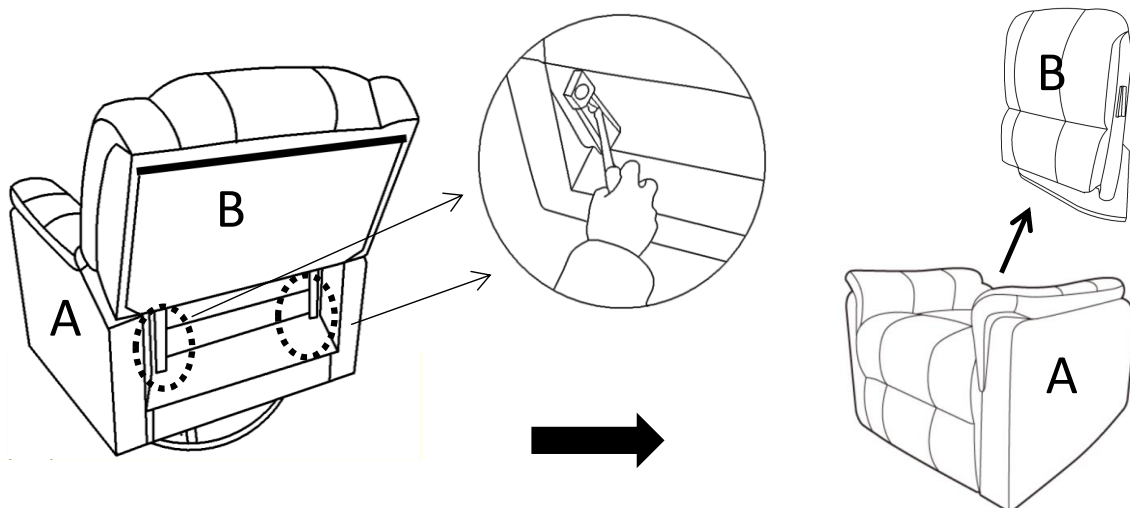

### **To Disassemble Recliner:**

Open the flap on the Backrest(A), use a screwdriver (Don't use your fingers) pressing outward on the metal ear on the preattached Metal Bracket on one side of the Chair Base(B).

With assistance of your adult partner to keep the Chair Base(B) in place, pull the Backrest(A) upward at the same time, repeat the same step for another side.

## Warning

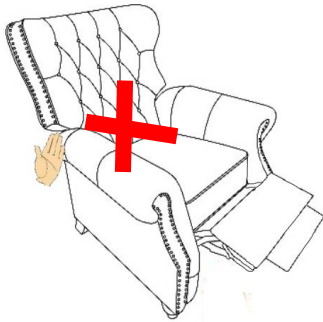
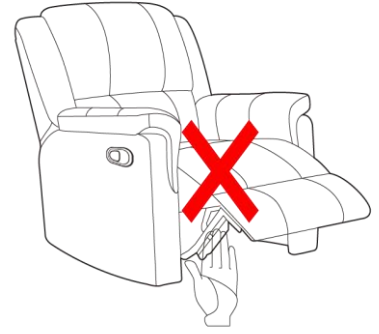
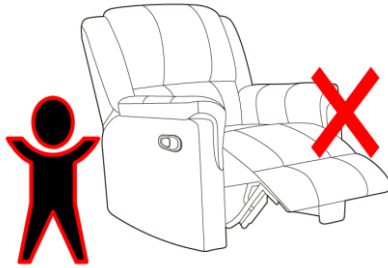
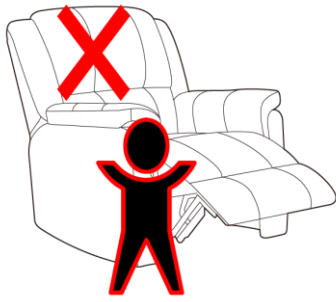

Keep hands and feet clear of the footrest mechanism and any gaps.  
Do not allow children to play on the chair.  
Always leave the chair in an upright and closed position after use.  
Do not sit on the arms of the recliner.  
Do not stand upon the recliner.  
Only the occupant should operate the chair.

## User Instructions.

### Glider Recliner With Swivel

Please read the Instruction Manual below carefully before use.

This is a Recliner Chair. At anytime in a reclined seat position or in the upright position. You may enjoy the rocking motion by using your body weight in a back-front rocking motion, and swivel motion as well.

Supervise children, when in use of this Recliner.



## To get into the Recline position:

Sit into the seat.

Open the trigger on the outside of right armrest.

Use your body weight and push backwards into the seat into a fully reclined position.

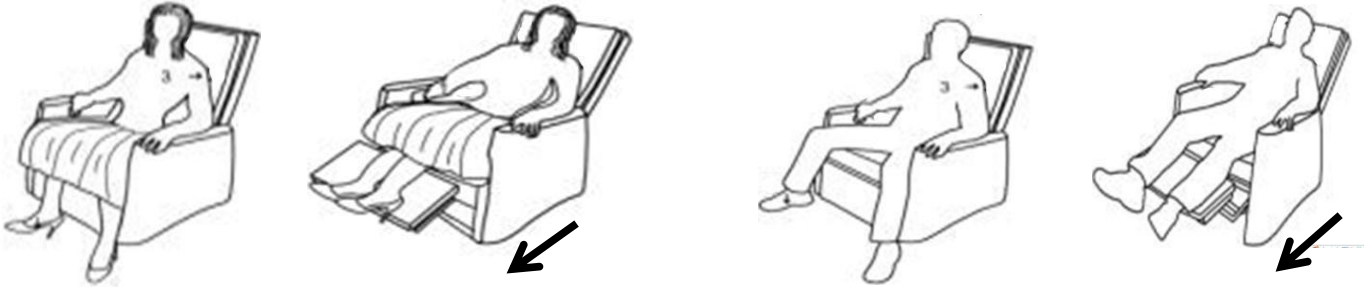

## To move the Chair back into the Upright position:

Tilt your body weight slightly forward and upwards.

The seat back will come up to an upright position.







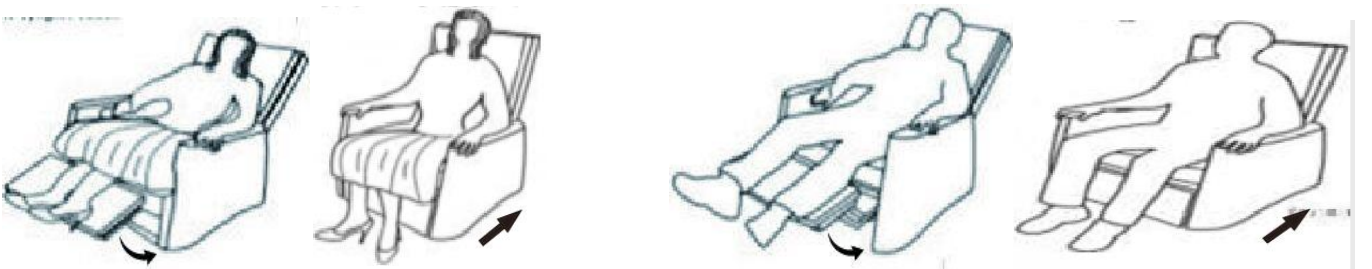













Use your feet to push the Footrest down.

The Chair will automatically lock when it is in the fully upright position.

Where necessary, use your arms help lift/push yourself out of the seat



## Care & Maintenance

-   ● Do not put hot items directly on furniture surface
  -   ● Do not clean furniture with harsh cleansers or polish.
  -   ● Do not place furniture under direct sunlight.
  -   ● Do not place furniture near heating or cooling vents.
  -   ● Do not write on furniture without a padded barrier to protect the surface.
  -   ● Do not place furniture outside . For indoor use only .
  -   ● Not for commercial use. For residential use only .
  -   ● Stains may be removed with mild soap solution and damp cloth.
  -   ● Children should not climb or jump on the furniture.
- 
-   ● Dust and pick-up spills using a clean, non-colored, lint-free cloth .

### Questions & Answers about Proposition 65

#### • What is Proposition 65?

Proposition 65 requires businesses to provide warnings to Californians about significant exposures to chemicals that cause cancer, birth defects or other reproductive harm. These chemicals can be in the products that Californians purchase, in their homes or workplaces, or that are released into the environment. By requiring that this information be provided, Proposition 65 enables Californians to make informed decisions about their exposures to these chemicals.

Proposition 65 also prohibits California businesses from knowingly discharging significant amounts of listed chemicals into sources of drinking water.

Proposition 65 requires California to publish a list of chemicals known to cause cancer, birth defects or other reproductive harm. This list, which must be updated at least once a year, has grown to include approximately 900 chemicals since it was first published in 1987.

#### • What types of chemicals are on the Proposition 65 list?

The list contains a wide range of naturally occurring and synthetic chemicals that include additives or ingredients in pesticides, common household products, food, drugs, dyes, or solvents. Listed chemicals may also be used in manufacturing and construction, or they may be byproducts of chemical processes, such as motor vehicle exhaust.

#### • What does a warning mean?

If a warning is placed on a product label or posted or distributed at a workplace, a business, or in rental housing, the business issuing the warning is aware or believes that it is exposing individuals to one or more listed chemicals.

By law, a warning must be given for listed chemicals unless the exposure is low enough to pose no significant risk of cancer or is significantly below levels observed to cause birth defects or other reproductive harm.

#### • Where can I get more information on Proposition 65?

If you have specific questions on the administration or implementation of Proposition 65, you can contact OEHHA's Proposition 65 program at [P65.Questions@oehha.ca.gov](mailto:P65.Questions@oehha.ca.gov), or by phone at (916) 445-6900.