



INSTALLATION GUIDE

## Kitchen Strainer

ST-1 / ST-2 / ST-3 / BST-1 / BST-2

## **Congratulations on the purchase of your new Kraus plumbing fixture!**

Please keep the box and packaging materials until your product is completely installed. If you have any questions, require technical assistance or have any problems with your product:



**DO NOT RETURN TO STORE**

**Please contact our Customer Service Team  
1-800-775-0703 / [customerservice@kraususa.com](mailto:customerservice@kraususa.com)**

Have the model number available and retain a copy of your receipt with purchase date for reference.

If for any reason this product does not meet your expectations, please be sure to repack this product in the original box and packaging material to avoid damage during transit.

### **Prior to Installation:**

- Make sure you have all necessary parts by checking the diagram and parts list. If any part is missing or damaged, please contact Kraus Customer Service at 800-775-0703 for a replacement.

**For technical assistance or replacement parts, please contact Kraus Customer Service and one of our representatives will be happy to help:**  
Toll-Free: 800-775-0703 or [Customerservice@kraususa.com](mailto:Customerservice@kraususa.com)

The step-by-step guidelines in the installation instructions are a general reference for installing a Kraus Sink. Should there be any discrepancies, Kraus cannot be held liable. It is recommended to install all Kraus products by hiring a licensed professional.

### **Tools you will need:**



Safety Goggles



Phillips Screwdriver

## Diagram and Parts List

ST-1

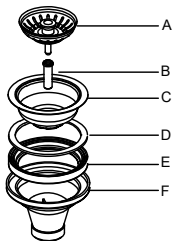

- A. Strainer Cover
- B. Screw
- C. Metal Strainer
- D. Foam Gasket
- E. Rubber Gasket
- F. Main Body

ST-2

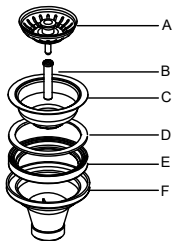

- A. Strainer Cover
- B. Screw
- C. Metal Strainer
- D. Foam Gasket
- E. Rubber Gasket
- F. Main Body

## Diagram and Parts List

BST-1

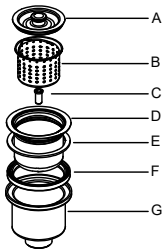

- A. Strainer Cover
- B. Basket
- C. Screw
- D. Metal Strainer
- E. Foam Gasket
- F. Rubber Gasket
- G. Main Body

BST-2

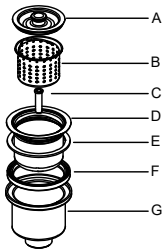

- A. Strainer Cover
- B. Basket
- C. Screw
- D. Metal Strainer
- E. Foam Gasket
- F. Rubber Gasket
- G. Main Body

## Diagram and Parts List

ST-3

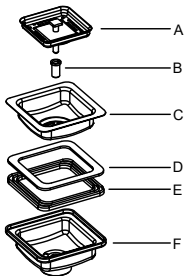

- A. Strainer Cover
- B. Screw
- C. Metal Strainer
- D. Foam Gasket
- E. Rubber Gasket
- F. Main Body

## Dimensions

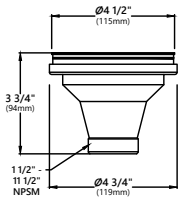

Model #: ST-1  
 Dimensions:  $\text{Ø}4 \frac{1}{2}'' \times 3 \frac{3}{4}''$

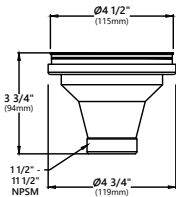

Model #: ST-2  
 Dimensions:  $\text{Ø}4 \frac{1}{2}'' \times 3 \frac{3}{4}''$

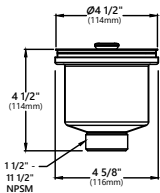

Model #: BST-1  
 Dimensions:  $\text{Ø}4 \frac{1}{2}'' \times 4 \frac{1}{2}''$

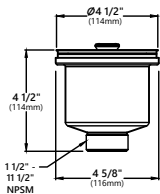

Model #: BST-2  
 Dimensions:  $\text{Ø}4 \frac{1}{2}'' \times 4 \frac{1}{2}''$

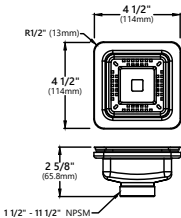

Model #: ST-3  
 Dimensions:  $4 \frac{1}{2}'' \times 4 \frac{1}{2}'' \times 2 \frac{5}{8}''$

## Step 1.

---

Disassemble strainer





## Step 2.

---

Insert metal strainer into drain hole with foam gasket attached. Install rubber gasket and main body underneath the sink

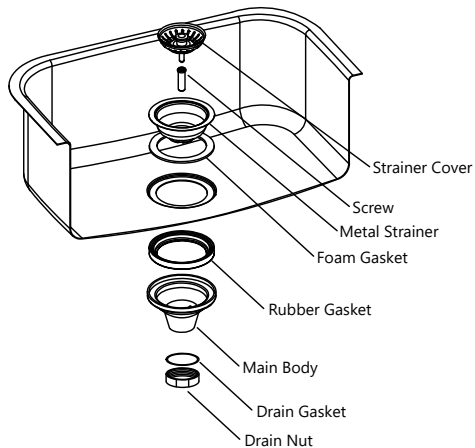

Step 3.

---

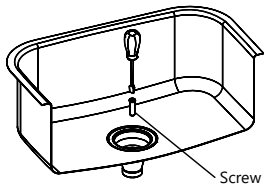

Using the screw, tighten the metal strainer and main body into place

Step 4.

---

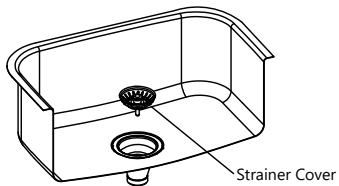

Insert strainer cover to seal water

## Replacement Parts

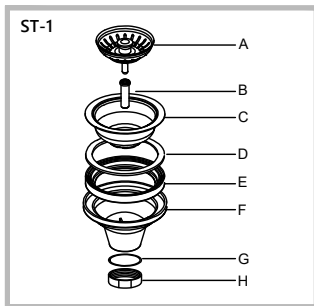

Replacement Parts List	Finish	Part #
A. Strainer Cover	SS*	KPU00010
A. Strainer Cover	PGM*	KPU00010-PGM
B. Screw 1 1/4"	SS*	KPU00003
B. Screw 1 1/4"	PGM*	KPU00003-PGM
C. Metal Strainer	SS*	KPU00011
C. Metal Strainer	PGM*	KPU00011-PGM
D. Foam Gasket		KPU00005
E. Rubber Gasket		KPU00006
F. Main Body		KPU00012
G. Drain Gasket		KPU00008
H. Drain Nut		KPU00009

\*Denotes faucet component color options:

SS - Stainless Steel

PGM - PVD Gunmetal

## Replacement Parts

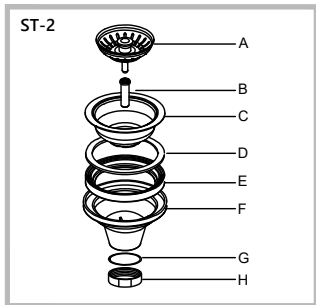

Replacement Parts List	Finish	Part #
A. Strainer Cover		KPU00010
B. Screw 1 5/8"		KPU00013
C. Metal Strainer		KPU00011
D. Foam Gasket		KPU00005
E. Rubber Gasket		KPU00006
F. Main Body		KPU00012
G. Drain Gasket		KPU00008
H. Drain Nut		KPU00009

## Replacement Parts

**BST-1**

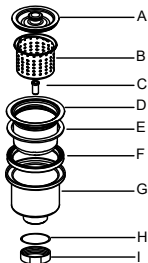

Replacement Parts List	Finish	Part #
A. Strainer Cover		KPU00001
B. Basket		KPU00002
C. Screw 1 1/4"		KPU00003
D. Metal Strainer		KPU00004
E. Foam Gasket		KPU00005
F. Rubber Gasket		KPU00006
G. Main Body		KPU00007
H. Drain Gasket		KPU00008
I. Drain Nut		KPU00009

**BST-2**

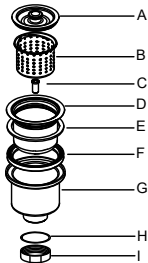

Replacement Parts List	Finish	Part #
A. Strainer Cover		KPU00001
B. Basket		KPU00002
C. Screw 1 5/8"		KPU00013
D. Metal Strainer		KPU00004
E. Foam Gasket		KPU00005
F. Rubber Gasket		KPU00006
G. Main Body		KPU00007
H. Drain Gasket		KPU00008
I. Drain Nut		KPU00009

## Replacement Parts

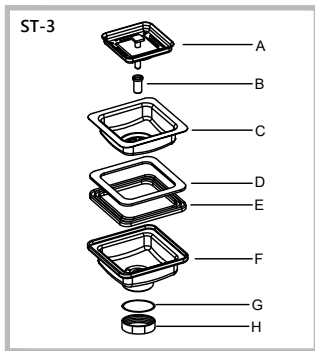

Replacement Parts List	Finish	Part #
A. Strainer Cover		KP22191
B. Screw		KP22198
C. Metal Strainer		KP22192
D. Foam Gasket		KP22193
E. Rubber Gasket		KP22194
F. Main Body		KP22195
G. Drain Gasket		KP22196
H. Drain Nut		KP22197

## **Accessories Warranty**

Kraus products are manufactured and tested to the highest quality standards by Kraus USA Inc. ("Kraus").

Kraus extends this warranty to the original purchaser for personal household use of the "Accessories" in their original location. The warranty is non-transferable.

Kraus warrants the structure and finish of the product (Accessories) to be free from defects in material and workmanship under normal usage for a period of one (1) years. The warranty commences from the initial date of purchase by the owner or trade professional, from an authorized Kraus dealer, through the one (1) year term of the original owner or end-user.

Any product reported to the authorized dealer or to Kraus as being defective within the warranty period will be repaired or replaced with a product of equal value at the option of Kraus. This warranty extends to the original owner or end-user, and is not transferable to a subsequent owner.

## **Restrictions**

This warranty does not cover antediluvian, discontinued, or display products, whether such items are purchased at discount outlets, unauthorized dealers, and/or sold on clearance.

This warranty does not cover instances of negligence, misuse, abuse, improper installation, carelessness, accident, hard water or mineral deposits, exposure to corrosive materials, misapplication, damages caused by improper maintenance, alteration of the product, or failure to follow care or installation instructions enclosed with your product. Avoid using abrasive cleaners such as powders, bleach, ammonia, alcohol, or chlorine. Avoid using abrasive pads, steel wool, or wire brushes, as these will damage and wear down the finish.

Kraus USA recommends that all Kraus products are installed by fully licensed and insured trade professionals with experience in the installation of bathroom and/or kitchen manufactured goods.

This warranty does not cover labor charges or costs of removal and reinstallation of said product. This warranty does not allow recovery of incidental or consequential damages such as loss of use, delay, property damage, or other consequential damages, and Kraus accepts no liability for such damages.

This warranty does not cover Marine or Outdoor Installation.

Except as otherwise provided above, Kraus makes no warranties, expressed or implied, including warranties of merchantability and fitness for a particular purpose, or compliance with any code.

Shipping charges will be covered for the first (1) year of the warranted replacement part or product (HI, AK, and Puerto Rico shipping charges may apply). International shipping fees are not included.

## **Commercial Warranty**

Kraus extends the above warranty for a period of one (1) year to purchasers of products for industrial, commercial, and business use.

All incidental or consequential damages are specifically excluded. No additional warranties, express or implied, are given, including but not limited to any implied warranty of merchantability or fitness for a particular purpose.

Some states do not allow the exclusion or limitation of incidental or consequential damages, or limitations on how long an implied warranty lasts, so the above limitations or exclusions may not apply to you.

This warranty gives you specific legal rights, and you may also have other rights which vary from state to state.

KRAUS USA has the right to change, modify, and/or update the warranty policy at any time. For the latest, most up to date comprehensive warranty, go to [www.kraususa.com/warranty](http://www.kraususa.com/warranty).

If you are a **HOMEOWNER**, please contact a Kraus Customer Service Representative at:

Kraus USA, Inc.  
12 Harbor Park Drive  
Port Washington, NY 11050  
Toll-Free : 800-775-0703  
Customerservice@kraususa.com

If you are a **PLUMBING CONTRACTOR OR TRADE PROFESSIONAL**, please contact a Kraus Pro Representative at:

Kraus USA, Inc.  
12 Harbor Park Drive  
Port Washington, NY 11050  
516-801-8955  
Proservice@kraususa.com

If you are an **AUTHORIZED PARTNER**, please contact a Partner Support Representative at:

Kraus USA, Inc.  
12 Harbor Park Drive  
Port Washington, NY 11050  
516-801-8954  
Partnersupport@kraususa.com

In requesting warranty service, please be ready to provide:

1. Proof of purchase
2. A description of the problem

**Download the Kraus Care & Maintenance Guide at:**  
<http://www.kraususa.com/maintenance>



# IMPORTANT

## Register Your Kraus Product

Activate Your Warranty

Access Premium Customer Support

Get Product Information

**REGISTER TODAY**

<http://www.kraususa.com/registration>



**Kräus**  
www.kraususa.com