

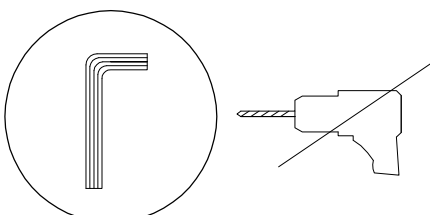



|   |   |   |
|---|---|---|
|  |  |  |
|  |  | <p>20'</p>  |
|   |   |  |
|   |   | <p>2</p>  |

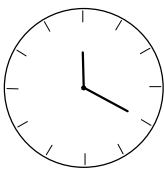
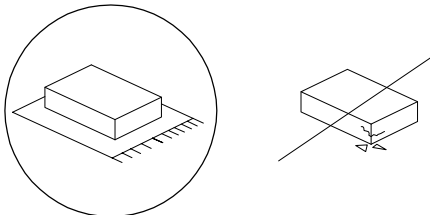

| A   | B   | C                    | D   |
|-----|-----|----------------------|-----|
|     |     |                      |     |
| x 1 | x 4 | M8<br>x<br>65<br>x 8 | x 1 |

1

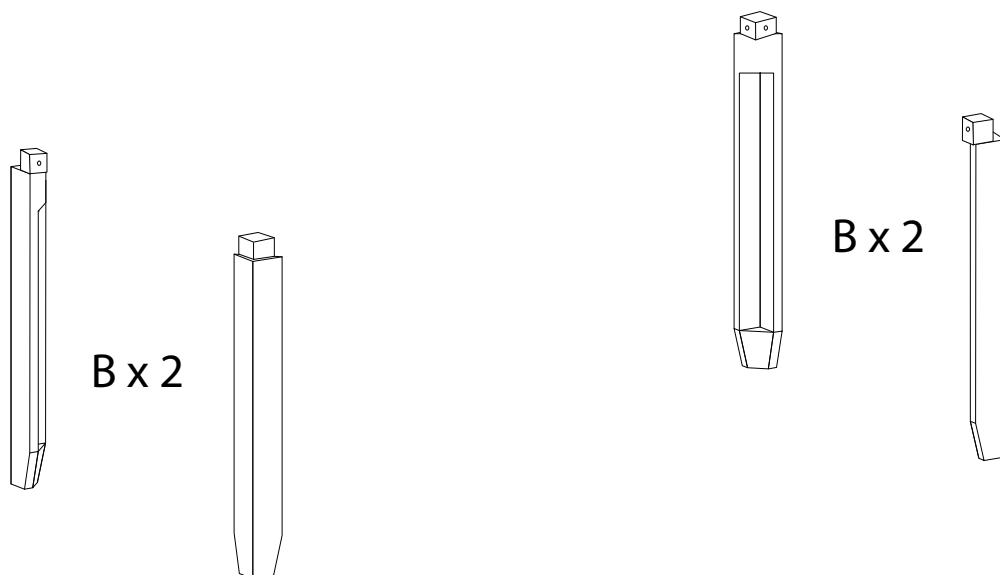
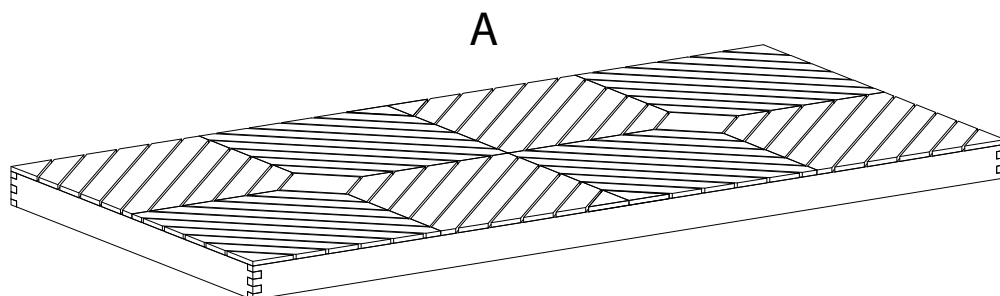