

Patio Dinging Chair

*Thank you very much
for purchasing our product*

INSTRUCTION MANUAL

Chaise Patio Dinging

*Merci beaucoup
pour acheter notre produit*

MANUEL D'INSTRUCTIONS

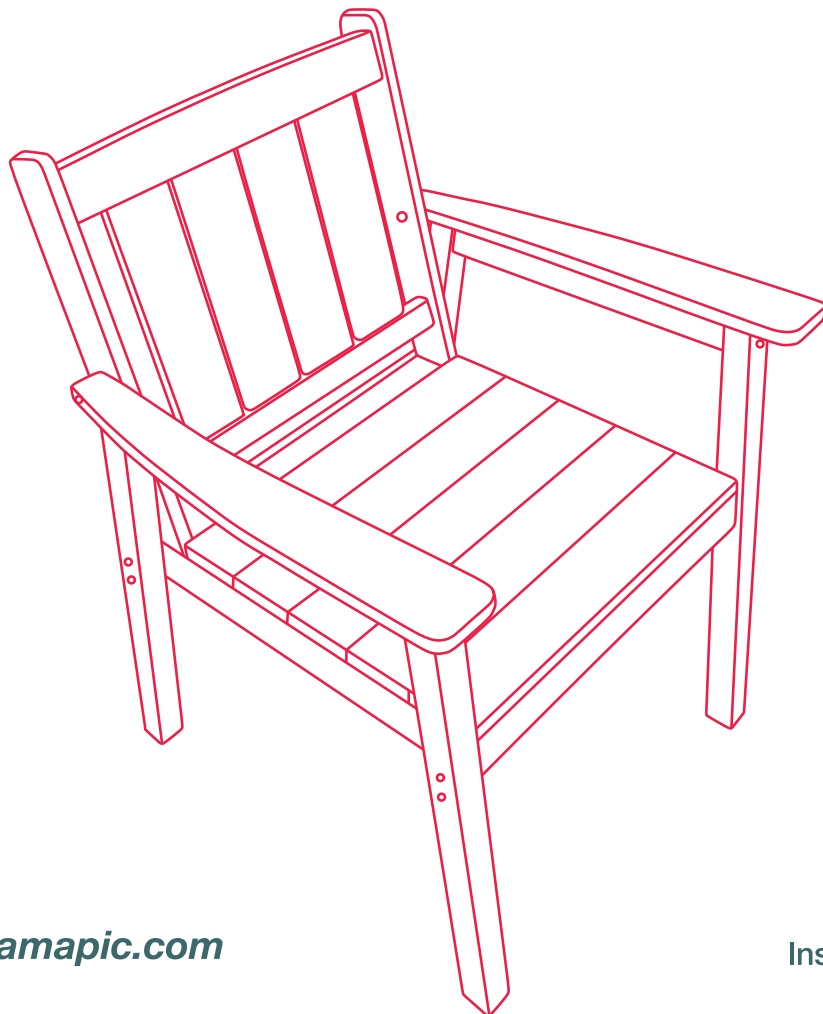

- E-mail
support@pamapie.com
- Facebook
[@pamapie.official](https://www.facebook.com/pamapie.official)

Instruction
Video
▶
Vidéo
d'instruction





If you have any question please contact customer service:
Si vous avez des questions, veuillez contacter le service client :

E-mail: support@pamapic.com
Facebook: [@pamapic.official](https://www.facebook.com/pamapic.official)



CAUTION

Before use

- If any part is missing, contact our customer service at support@pamapic.com for assistance.
- Exercise caution when assembling the products, as some parts may have sharp edges.
- Before fully assembling the product, keep all components and accessories away from children and pets.
- Assemble the item on a soft non-abrasive surface such as carpeting to avoid damage.

During use

- For your safety, avoid using this item as a stepladder.
- Before use, ensure all bolts, screws, and knobs are securely fastened, checking every 90 days.
- Do not use or store near open flammable or combustible chemicals.
- If any parts are missing, broken, damaged, or worn, refrain from using the product until repairs are made or factory replacement parts are installed.
- Heat Resistance: The product can withstand temperatures up to 230°F (110°C). Avoid placing high-temperature objects (such as grills or hot pots) directly on the surface to prevent damage. Using heat-resistant mats is recommended.

After use

- Before assembling the product, carefully compare each part with the parts list. If you discover any missing or damaged parts, do not proceed with assembly; instead, contact us immediately for assistance.
- We value every customer's user experience, so please feel free to reach out with any suggestions or feedback, and we will promptly provide an efficient solution.

Warranty Coverage Requirements

- If your appliance fails within 1 year of purchase due to non-human damage, our team will replace it free of charge. For the quickest resolution, please send us photos of the damaged parts along with the make and model number of your product.

If you have any question please contact customer service:
Si vous avez des questions, veuillez contacter le service client :

E-mail: support@pamapic.com
Facebook: [@pamapic.official](https://www.facebook.com/pamapic.official)



PRUDENCE

Avant utilisation

- Si une pièce manque, contactez notre service à la clientèle à support@pamapic.com pour obtenir de l'aide.
- Faites preuve de prudence lors de l'assemblage des produits, car certaines pièces peuvent avoir des bords pointus.
- Avant d'assembler complètement le produit, gardez tous les composants et accessoires à l'écart des enfants et des animaux de compagnie.
- Assemblez l'article sur une surface douce non abrasive telle que le tapis pour éviter les dommages.

Pendant l'utilisation

- Pour votre sécurité, évitez d'utiliser cet article comme escalier.
- Avant utilisation, assurez-vous que tous les boulons, vis et boutons sont bien fixés, en vérifiant tous les 90 jours.
- Ne pas utiliser ou stocker près de produits chimiques inflammables ou combustibles.
- Si des pièces sont manquantes, cassées, endommagées ou usées, évitez d'utiliser le produit jusqu'à ce que les réparations soient effectuées ou que des pièces de rechange d'usine soient installées.
- Résistance à la chaleur: le produit peut résister à des températures allant jusqu'à 230 °F (110°C). Évitez de placer des objets à haute température (tels que des grills ou des pots chauds) directement sur la surface pour éviter les dommages. L'utilisation de tapis résistants à la chaleur est recommandée.

Après utilisation







- Avant d'assembler le produit, comparez soigneusement chaque pièce avec la liste des pièces. Si vous découvrez des pièces manquantes ou endommagées, ne procédez pas à l'assemblage; plutôt, contactez-nous immédiatement pour obtenir de l'aide.
- Nous apprécions l'expérience utilisateur de chaque client, alors n'hésitez pas à communiquer avec toute suggestion ou commentaire, et nous fournirons rapidement une solution efficace.

Exigences de couverture de garantie

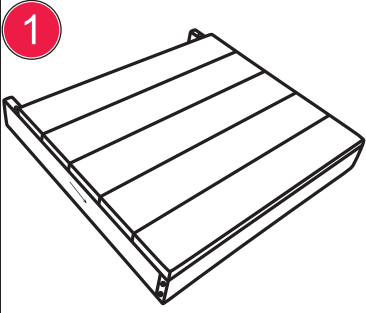
- Si votre appareil échoue dans un délai de 1 an après l'achat en raison de dommages non humains, notre équipe le remplacera gratuitement. Pour la résolution la plus rapide, veuillez nous envoyer des photos des pièces endommagées ainsi que le numéro de marque et de modèle de votre produit.

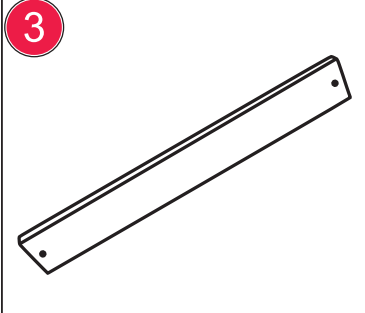
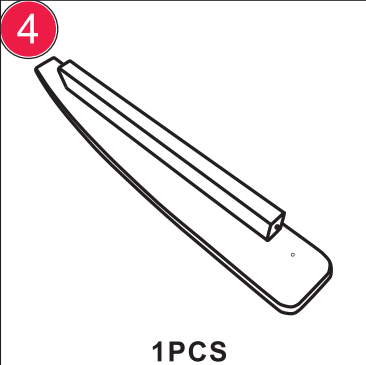
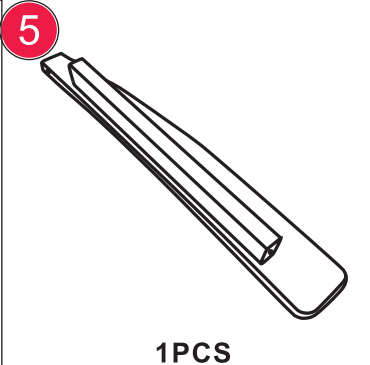
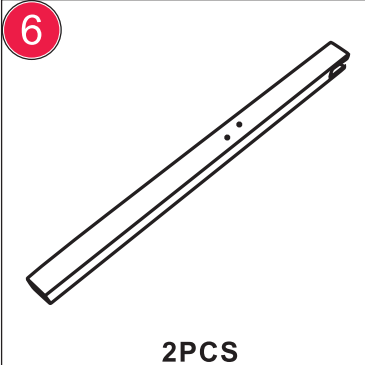
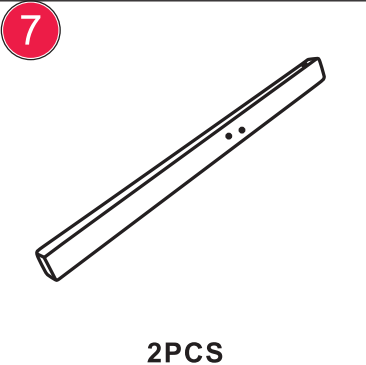
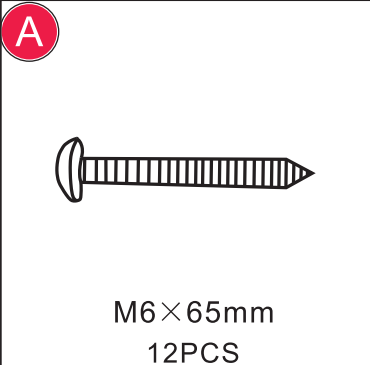
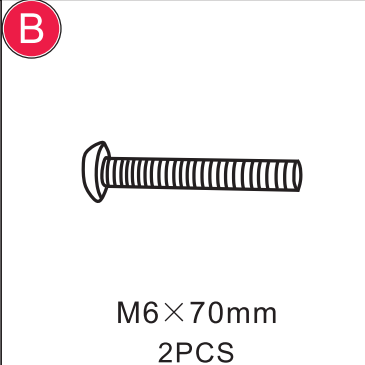
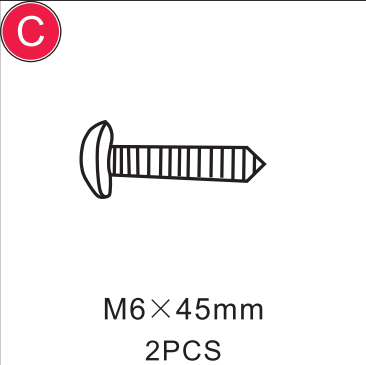

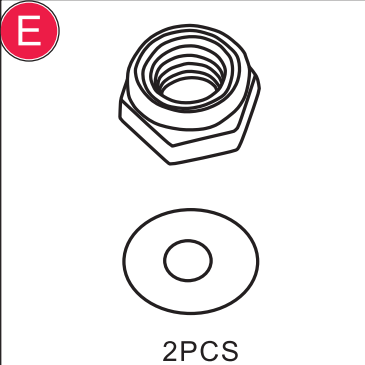
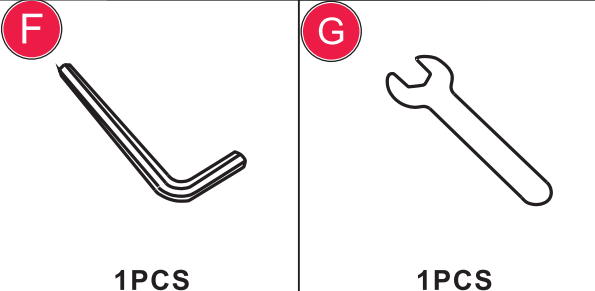
PARTS

 <p>1</p> <p>1PCS</p>	 <p>2</p> <p>1PCS</p>	 <p>3</p> <p>1PCS</p>
 <p>4</p> <p>1PCS</p>	 <p>5</p> <p>1PCS</p>	 <p>6</p> <p>2PCS</p>
 <p>7</p> <p>2PCS</p>	 <p>A</p> <p>M6×65mm 12PCS</p>	 <p>B</p> <p>M6×70mm 2PCS</p>
 <p>C</p> <p>M6×45mm 2PCS</p>	 <p>D</p> <p>M6×90mm 2PCS</p>	 <p>E</p> <p>2PCS</p>
 <p>F</p> <p>1PCS</p>		 <p>G</p> <p>1PCS</p>



If you have any question please contact customer service:
Si vous avez des questions, veuillez contacter le service client :

E-mail: support@pamapic.com
Facebook: [@pamapic.official](https://www.facebook.com/pamapic.official)



INSTRUCTIONS

Step 1

 M6×45mm	
2PCS	1PCS

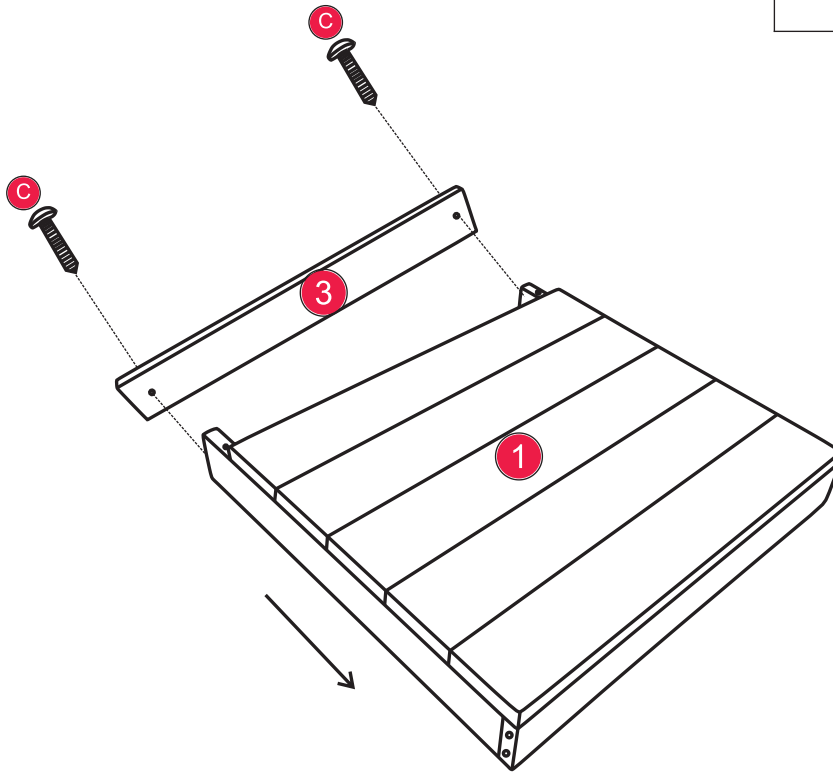

Steps upon completion of installation

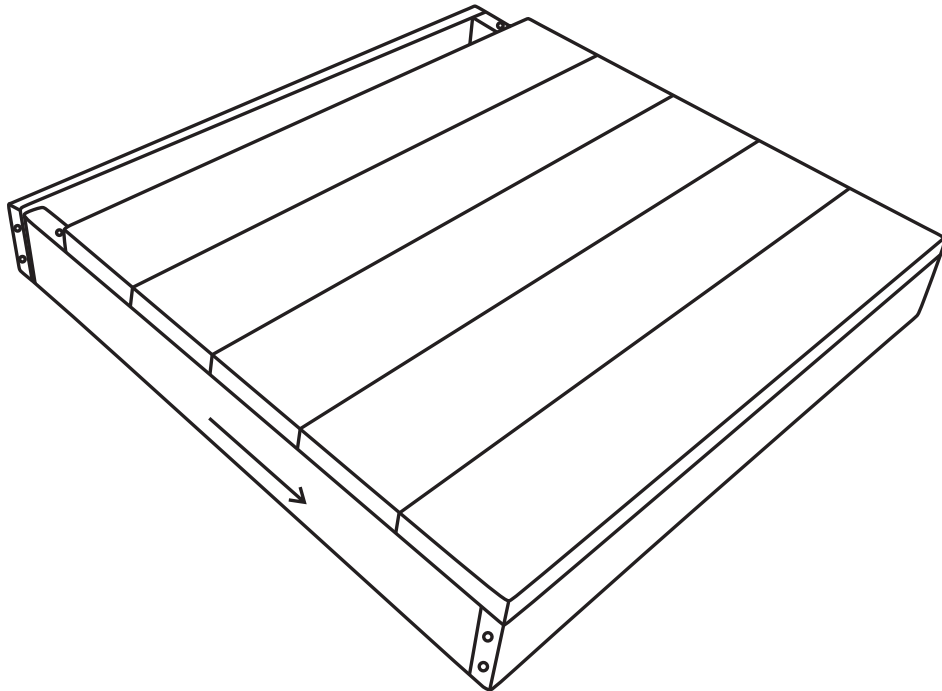

If you have any question please contact customer service:
Si vous avez des questions, veuillez contacter le service client :

E-mail: support@pamapic.com
Facebook: [@pamapic.official](https://www.facebook.com/pamapic.official)



INSTRUCTIONS

Step 2

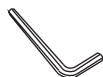
 M6×65mm	
8PCS	1PCS

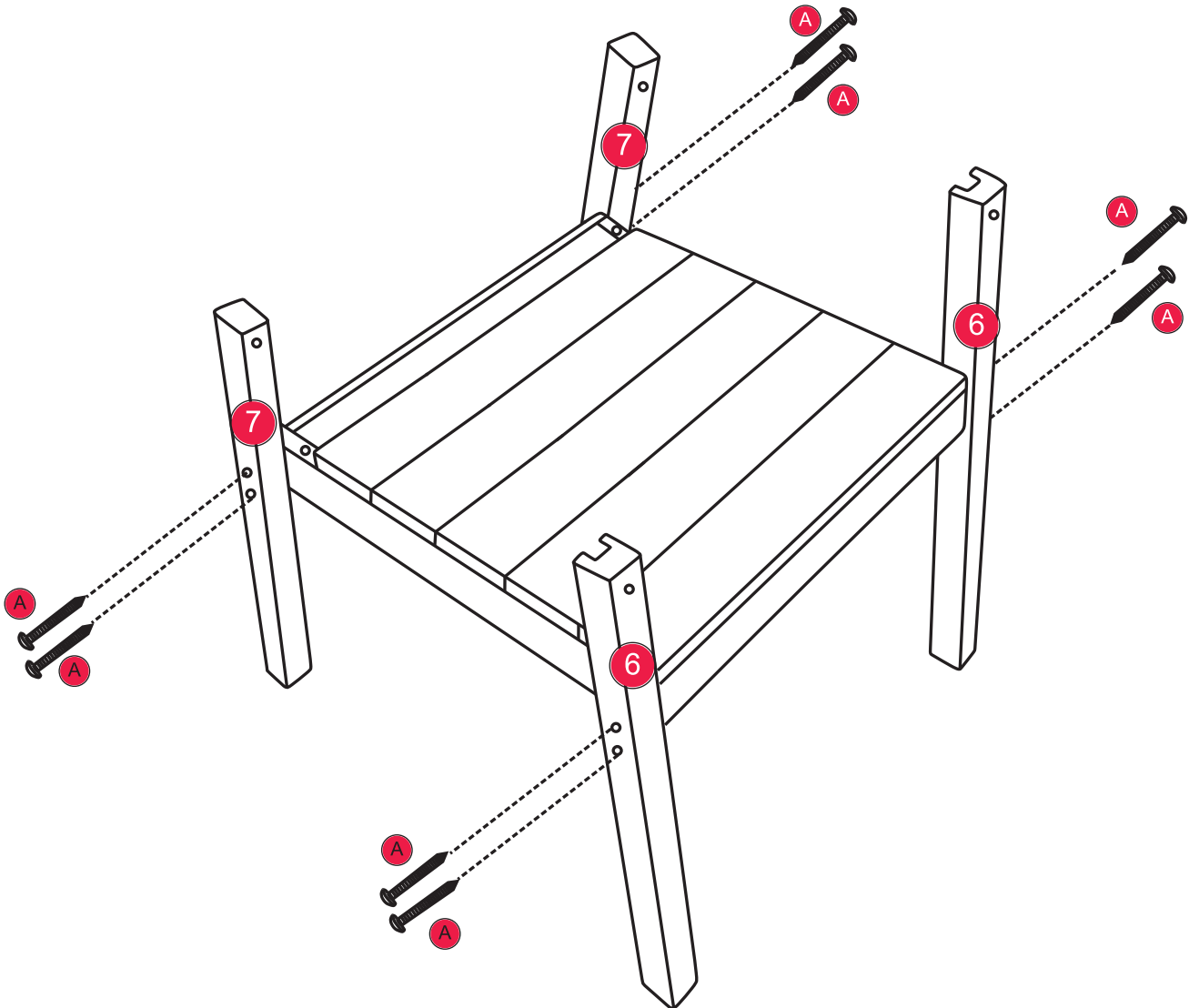



If you have any question please contact customer service:
Si vous avez des questions, veuillez contacter le service client :

E-mail: support@pamapic.com
Facebook: [@pamapic.official](https://www.facebook.com/pamapic.official)



INSTRUCTIONS

Step 3

 M6×90mm	
2PCS	1PCS

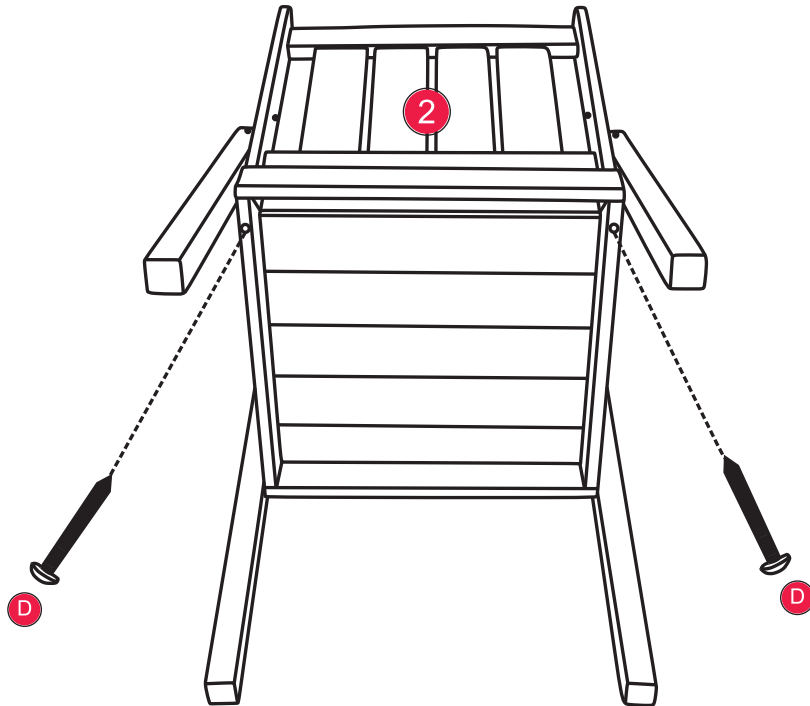

Steps upon completion of installation

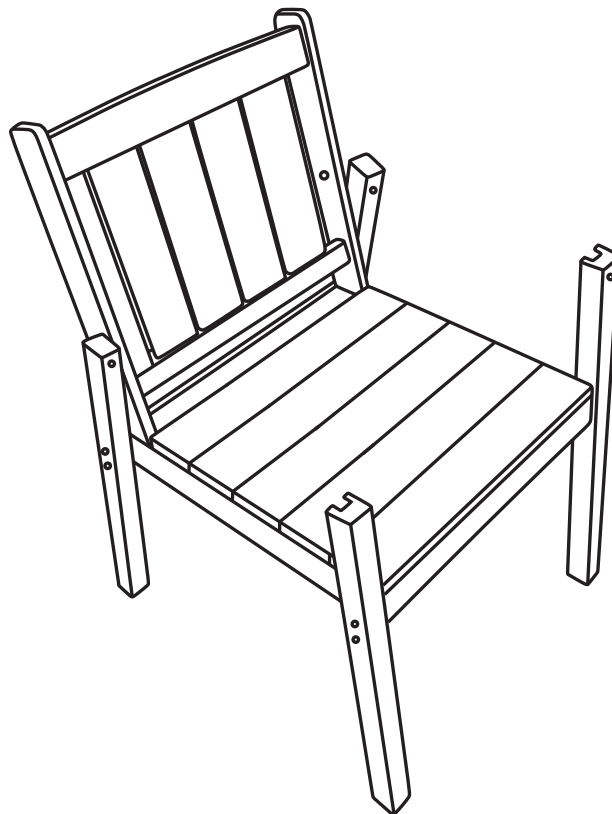



If you have any question please contact customer service:
Si vous avez des questions, veuillez contacter le service client :

E-mail: support@pamapic.com
Facebook: [@pamapic.official](https://www.facebook.com/pamapic.official)



INSTRUCTIONS

Step 4

 M6×65mm	
4PCS	1PCS

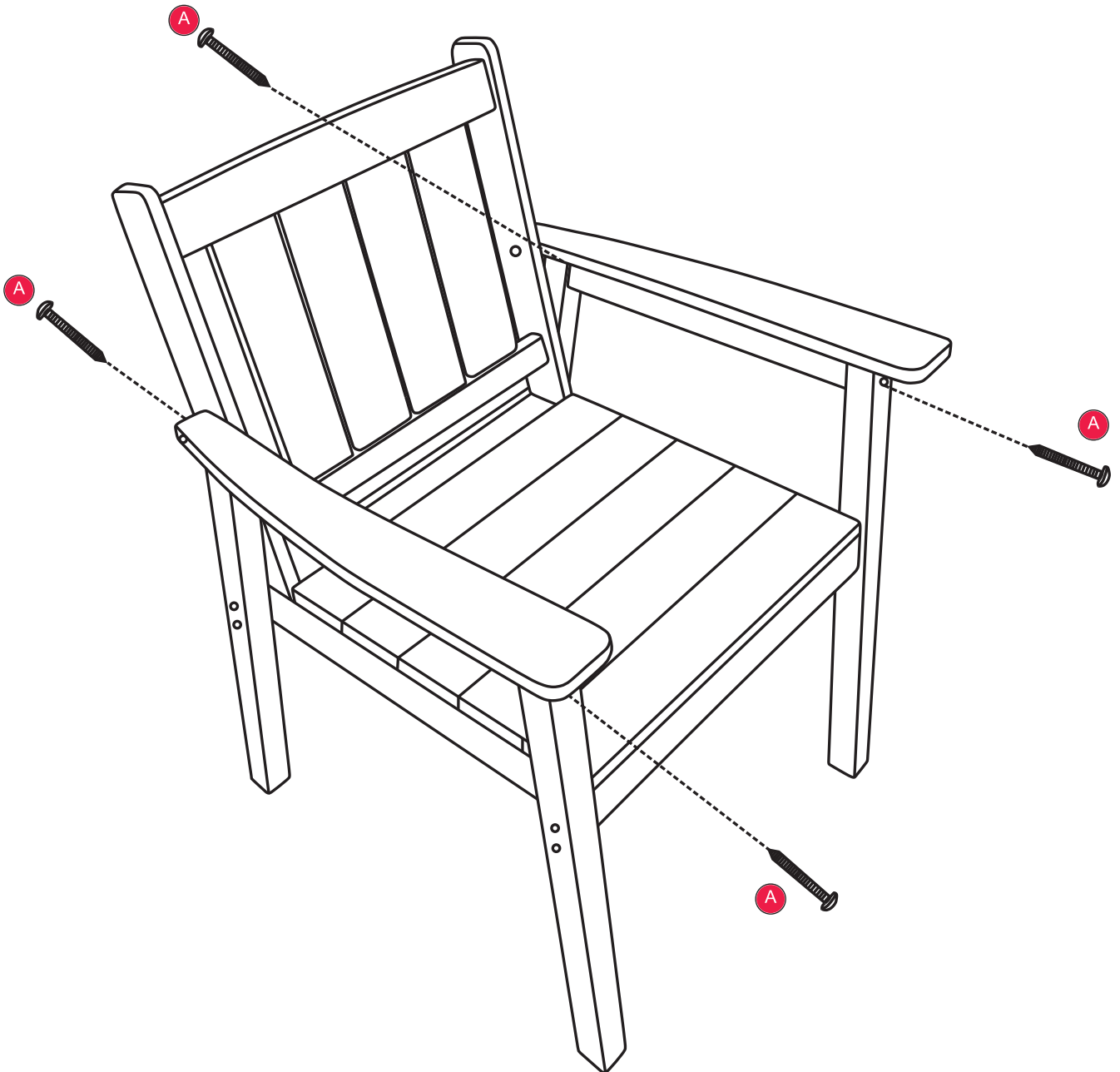





If you have any question please contact customer service:
Si vous avez des questions, veuillez contacter le service client :

E-mail: support@pamapic.com
Facebook: [@pamapic.official](https://www.facebook.com/pamapic.official)



INSTRUCTIONS

Step 5

 M6×65mm			
4PCS	2PCS	1PCS	1PCS

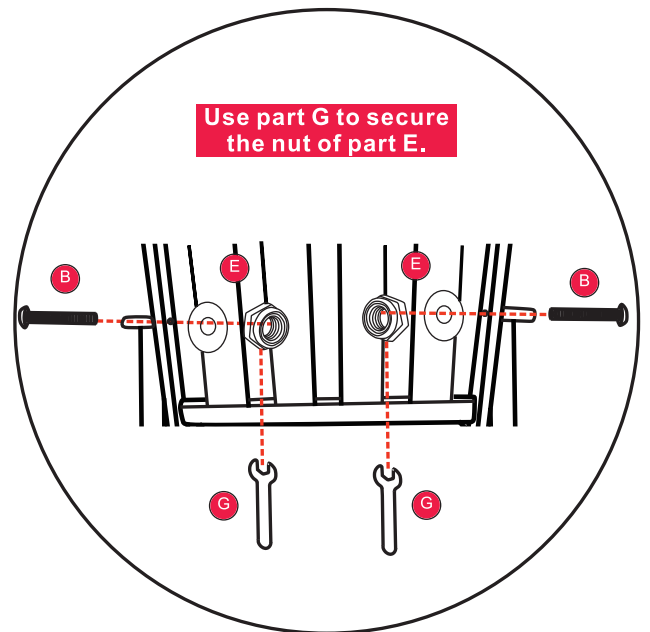
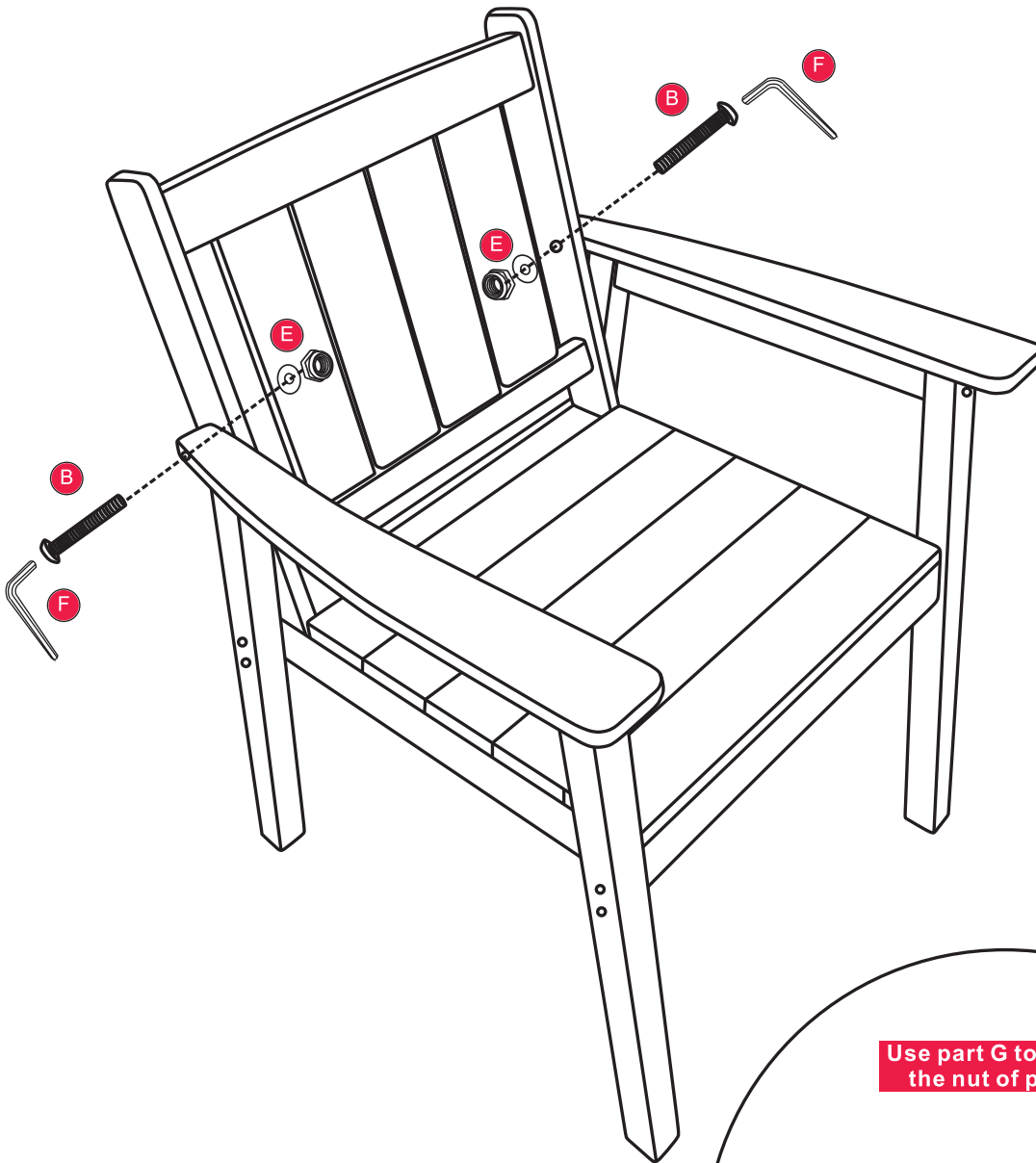

If you have any question please contact customer service:
Si vous avez des questions, veuillez contacter le service client :

E-mail: support@pamapic.com
Facebook: [@pamapic.official](https://www.facebook.com/pamapic.official)



INSTALLATION COMPLETED

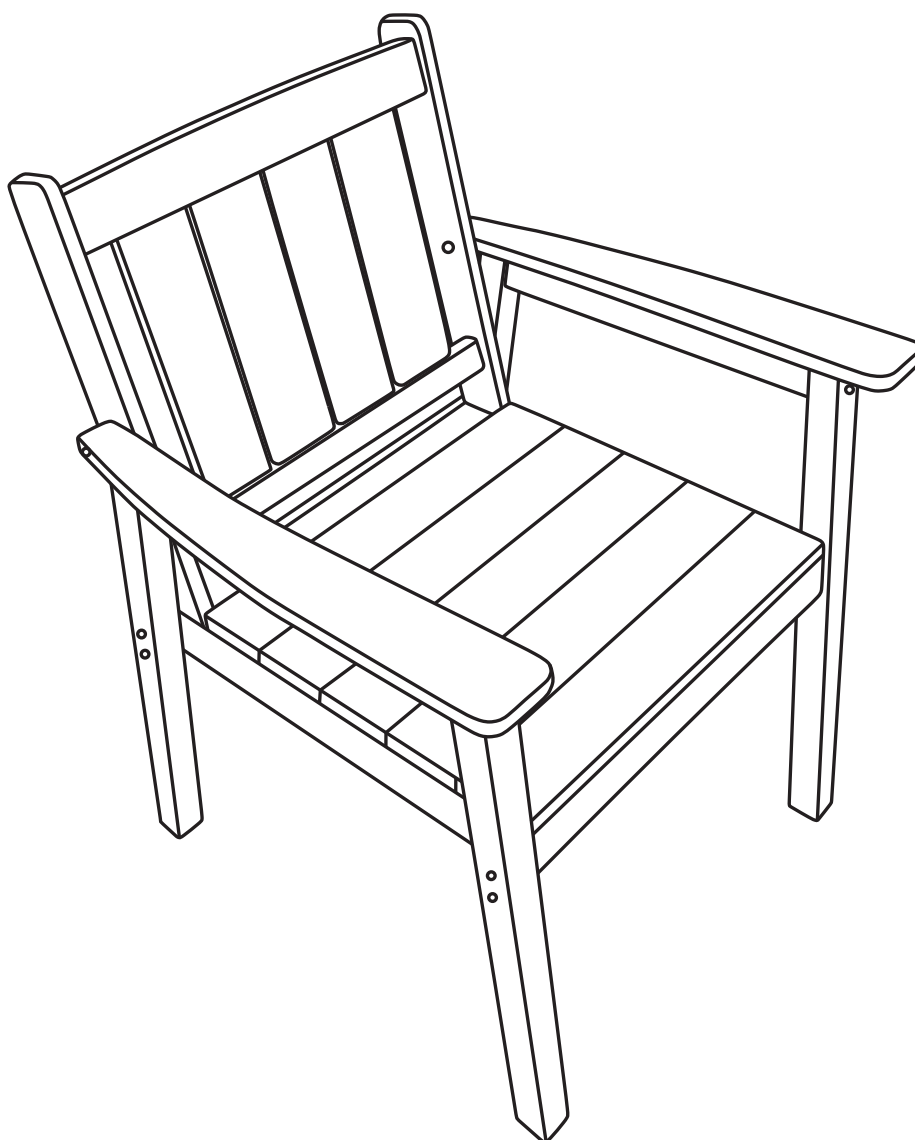

If you have any question please contact customer service:
Si vous avez des questions, veuillez contacter le service client :

E-mail: support@pamapic.com
Facebook: [@pamapic.official](https://www.facebook.com/pamapic.official)





If you have any question please contact customer service:
Si vous avez des questions, veuillez contacter le service client :

E-mail: support@pamapic.com
Facebook: [@pamapic.official](https://www.facebook.com/pamapic.official)



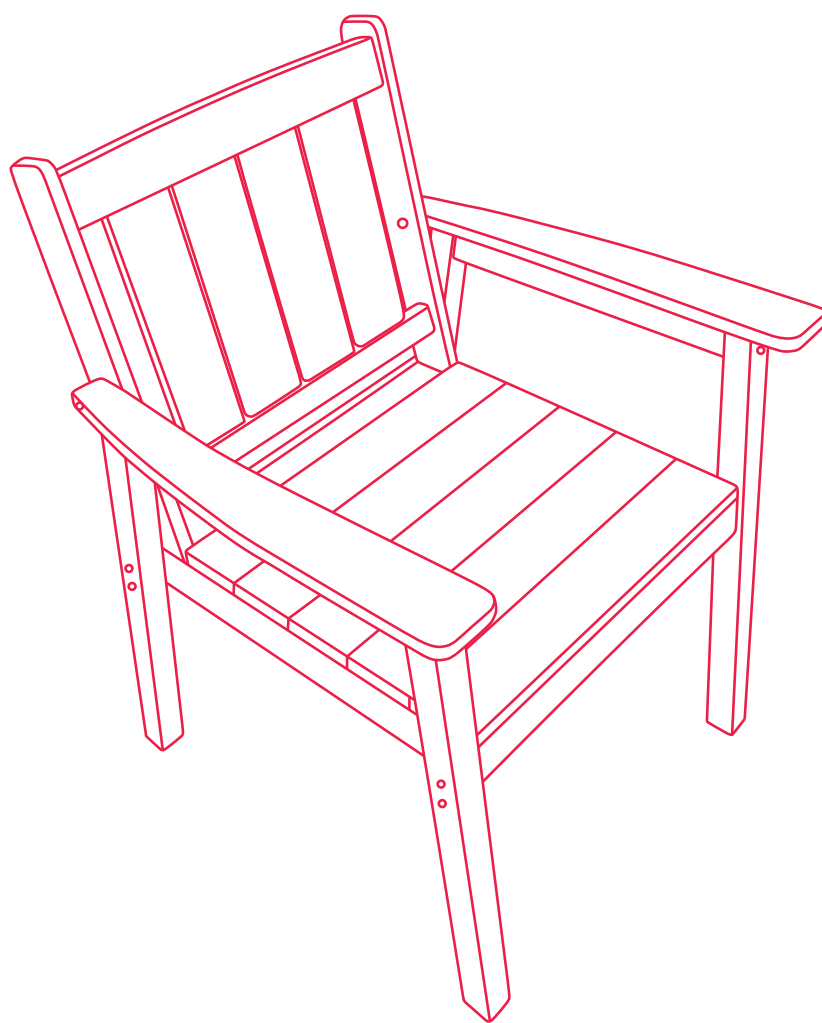

If you have any question please contact customer service:
Si vous avez des questions, veuillez contacter le service client :

E-mail: support@pamapic.com
Facebook: [@pamapic.official](https://www.facebook.com/pamapic.official)

