

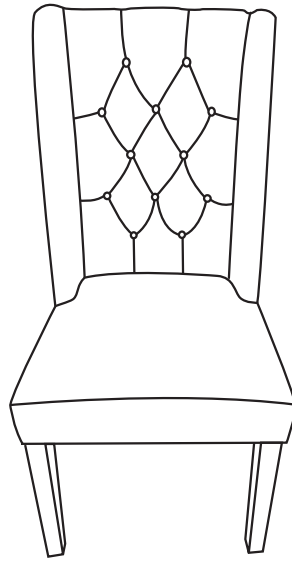



Assembly Instructions

Warnings: You must read this before you proceed.





Dining Chair



Parts List

| Label | Picture | Description | QTY |
|-------|---|-----------------|-----|
| A |  | Chair Back | 1 |
| B |  | Chair Seat | 1 |
| C |  | Front Leg | 2 |
| D |  | Seat Base Cover | 1 |





Hardware

| Label | Picture | Description | QTY |
|-------|--|---------------|-----|
| ① |  | Bolt M8X75 | 5 |
| ② |  | Bolt M8X60 | 6 |
| ③ |  | Spring Washer | 11 |
| ④ |  | Flat Washer | 11 |
| ⑤ |  | Allen Key | 1 |

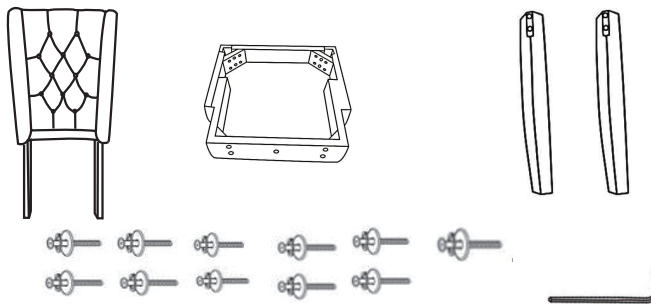
Assembly Preparation

Before
Beginning
Assembly:



-  • Read instructions, cover to cover-
-  • Have 2 adults on hand for assembly-
-  • Do not assemble on flooring or carpet-
-  • Assemble on a clean non-marring surface (packing foam)-
-  • Save all packaging until finished-

Assembly Steps

Overview

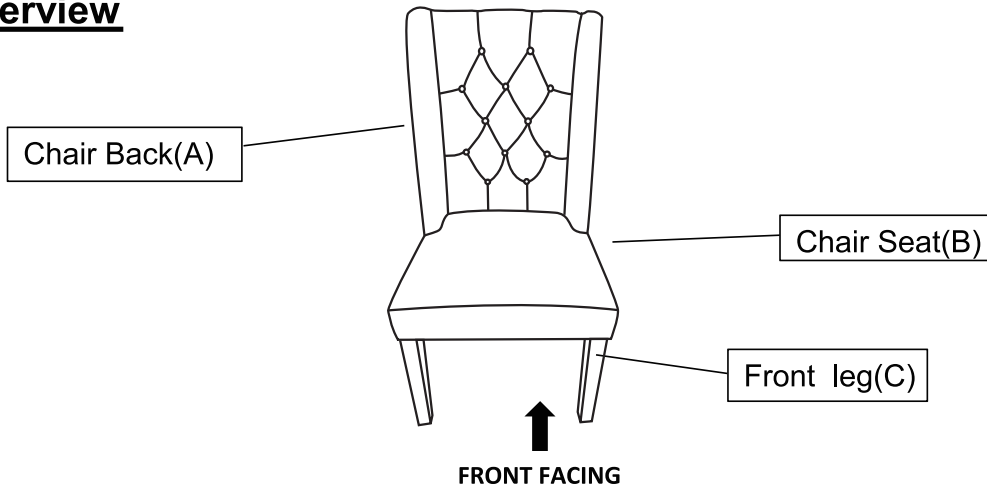

This Dining Chair has multiple parts and may require up to 30 minutes to assemble. To give you an overview of the Dining Chair parts, the above picture is to help you put the various parts into perspective. Please read through the instructions below to familiarise yourself with the parts and steps before assembly.

Step 1

Step 1.1

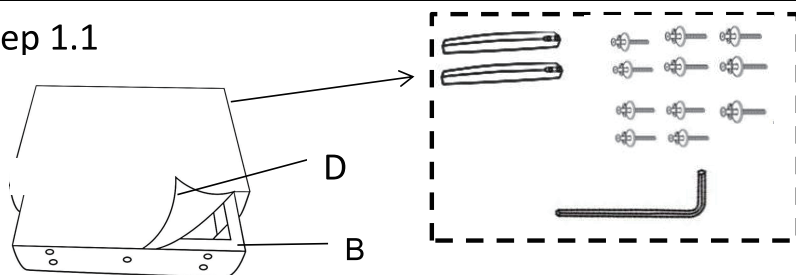

Position the Chair Seat(B) on its back, as shown. Preferably on a surface that will not scratch the upholstery.

Take out the 2 wooden legs and the package of hardware accessories under the chair seat.

Step 1.2

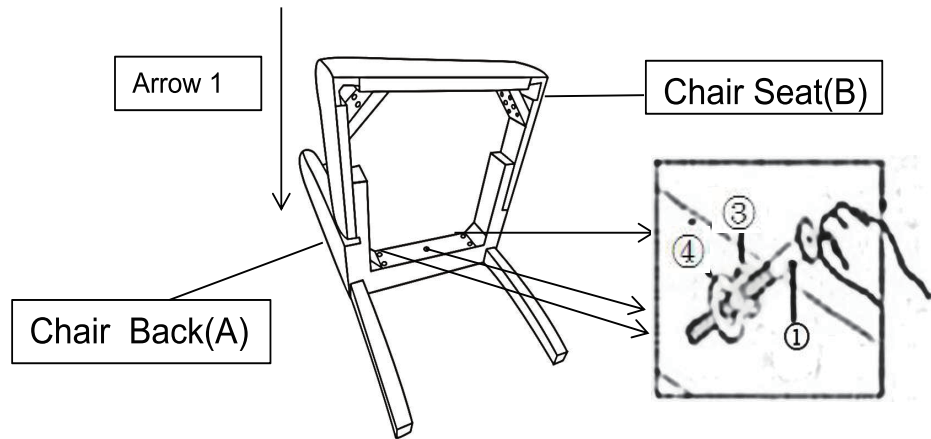

Put the Chair Back(A) onto a flat table or panel.
Align the positioning dowels on the Chair Seat(B)
with the mounting position located on the Chair Back-
panel and Chair-Seat panel.

Use your left hand to push the seat frame floorwards,
depicted by Arrow 1.

This action helps to ensure the Chair Seat(B) is
pressed towards to the Chair Back(A) with no gap
between these.

Then, lock the middle mounting position first and the
corner mounting position later.

The hardware for these are : use 5 Bolts (①)+ 5 Spring
Washers (③) + 5 Flat Washers (④) with the Allen
key(⑤).

At this point of assembly, DO NOT overfasten the
connections.

WARNING!! At this stage, Do not fully tighten Bolts.

Step 2

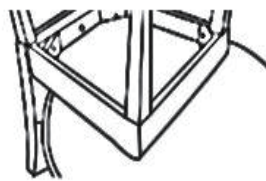
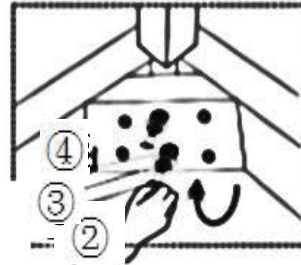

Picture 1

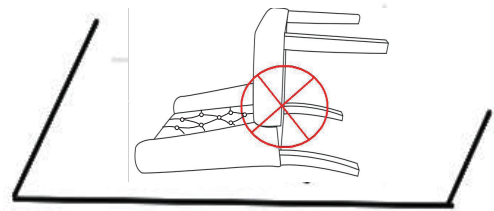

Picture 2

Next, place the chair onto the side of a table as seen in Picture 1. You will now have the chair bottom and all 4-legs facing skywards. Insert each front leg completely vertically into each seat frame corner. **PRESS FIRMLY DOWN** with your hand until there is no gap.

WARNING!! DO NOT POSITION THE FRONT LEG AS SHOWN IN PICTURE 2 .

THIS PICTURE SHOWS THE CHAIR BACK STAYS AGAINST THE GROUND and THE FRONT LEGS HORIZONTAL IN MIDAIR.

Now tighten the bottom bolt first, then the bolt on the top by using 4 Bolts (②) and 4 Spring Washers (③) and 4 Flat Washers (④).

DO NOT tighten the top bolt first.

WARNING!! DO NOT OVER TIGHTEN. OVER TIGHTENING COULD LEAD TO DAMAGE OF THE PRODUCT.

TIGHTEN ONLY UNTIL SECURE AND STABLE.

Step 3

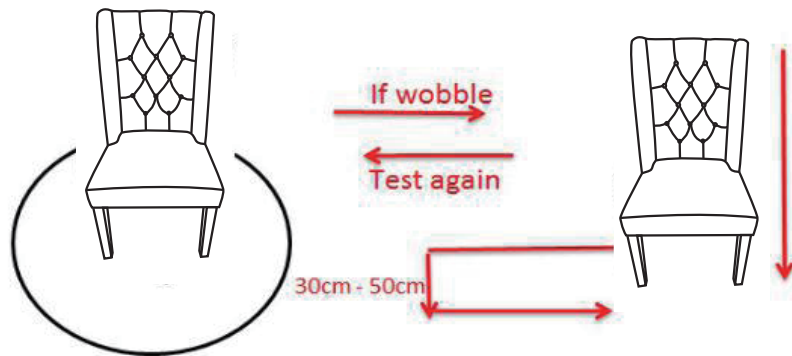





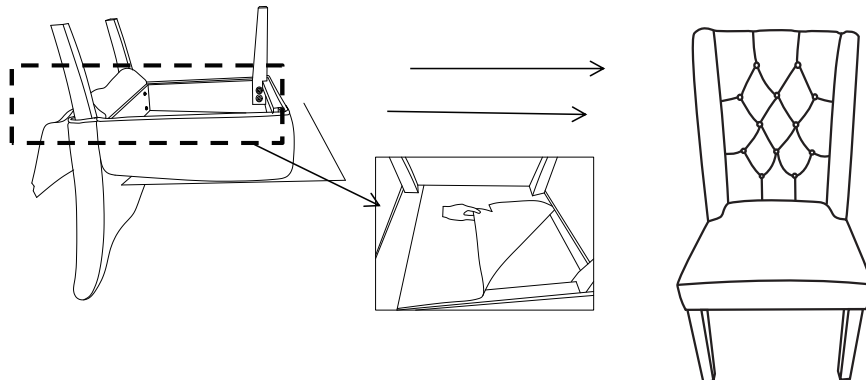















Place the chair on a **LEVEL SURFACE** to see if it wobbles.
If it wobbles, lift the chair to some 30cm to 50cm height from the ground.
Keep your feet and toes well away from the drop zone.
Drop the chair freely and vertically with the four legs, hitting the ground, at the same time.
This Drop Test will help to ensure that all the bolts and gaps to all reach full alignment status.
Test again for evenness on a **LEVEL SURFACE**.
If no wobbles found, proceed to tighten all the bolts.
CAUTION : When tightening these bolts, tighten sequentially.
DO NOT tighten any screw fully and then towards the next one.
This would cause the frame to warp.
If there is still wobbles, loosen the bolts and execute this same drop tests.
WARNING!! IF CHAIR IS NOT STABLE , IT COULD LEAD TO DAMAGING THE PRODUCT.

Step 4



Place the Seat Base Cover(D) back as shown in picture.
 Smooth the Magic Tape down with your hand on all four sides at the edge of the seat.
 Make sure all parts are connected and securely locked into position.
 Then stand the Dining Chair up.
 Your Dining Chair is ready for use.
This Dining Chair can only be used on a flat, level surface.

Care & Maintenance

-   ● Do not put hot items directly on furniture surface
 -   ● Do not clean furniture with harsh cleansers or polish.
 -   ● Do not place furniture under direct sunlight.
 -   ● Do not place furniture near heating or cooling vents.
 -   ● Do not write on furniture without a padded barrier to protect the surface.
 -   ● Do not place furniture outside . For indoor use only .
 -   ● Not for commercial use. For residential use only .
 -   ● Stains may be removed with mild soap solution and damp cloth.
 -   ● Children should not climb or jump on the furniture.
-
-   ● Dust and pick-up spills using a clean, non-colored, lint-free cloth .

What is Proposition 65?

Proposition 65 is a California law that requires warning labels on products that may contain one of more than 800-plus chemicals or ingredients that the California Office of Environmental Health Hazard Assessment (OEHHA) has deemed to cause cancer or other reproductive toxicity. Chemicals and elements on this list include wood dust, brass, and other everyday substances, which can be found in very common household items, such as: lamps, tableware, jewelry, crystal glasses, electric cords, beauty products, automobiles, and furniture.

Why Did I Find a Proposition 65 Warning on My Home Goods Product?

We include Proposition 65 warnings on all of our products because there is always a chance that one of the 800-plus common chemicals and ingredients listed under this law could potentially be on our furniture or packing materials. We risk large fines under this law, if we don't include this warning.

Should I worry?

We realize you may be worried finding this warning on our products, but we want to reassure you that the hazardous exposure limits for any of these chemicals have never been found on furniture products that we've shipped to our customers. Additionally, this warning label is very common and can be found on almost every piece of furniture sold in the state of California.

Just How Common Are Proposition 65 Warnings?

Proposition 65 warnings have become so common in California that it is hard to take a trip to a local bank, grocery store, or restaurant without finding at least one warning. In fact, even the Disney Land Resort has a Proposition 65 warning:

