

ASSEMBLY INSTRUCTION

MF320583

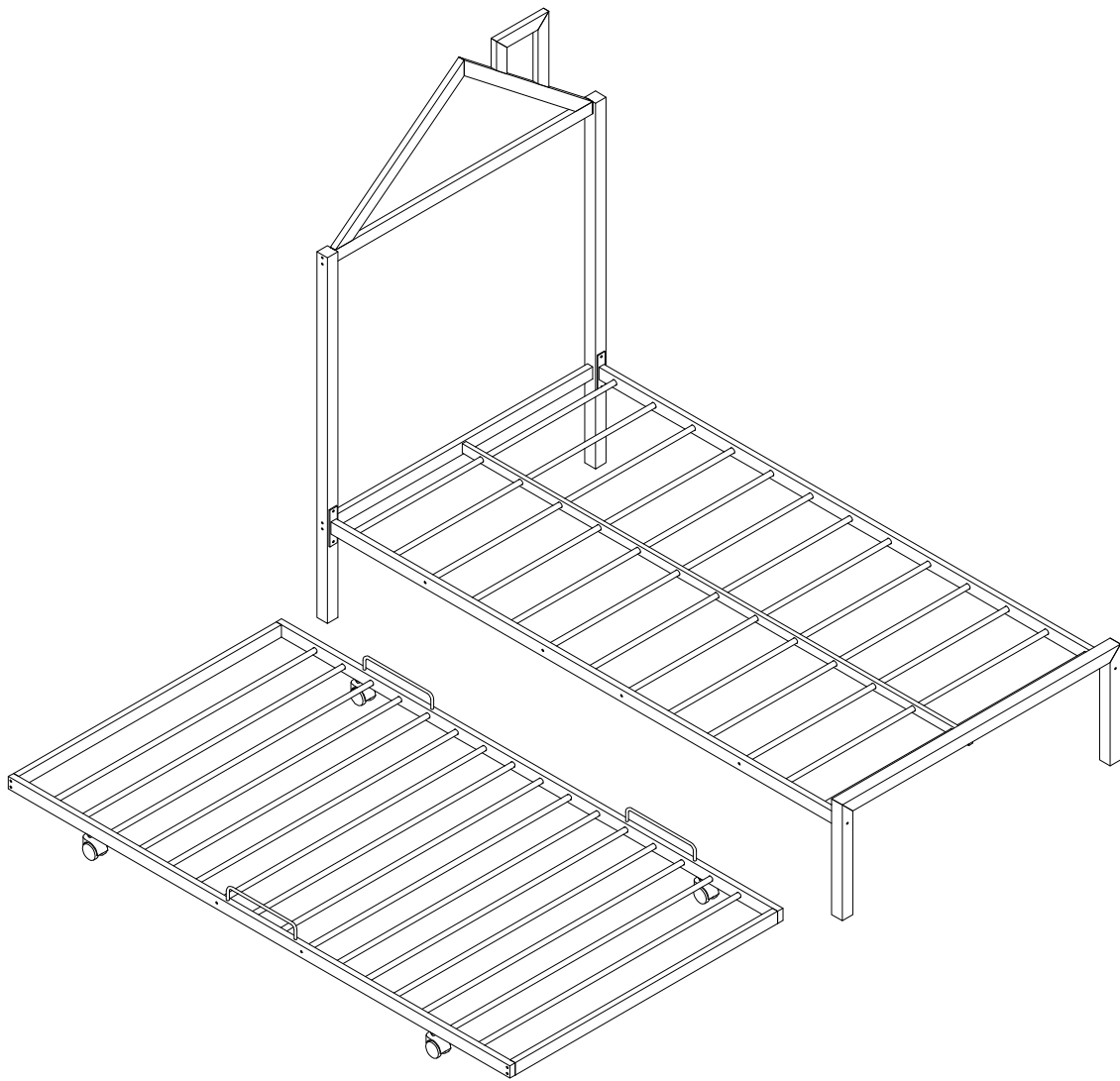

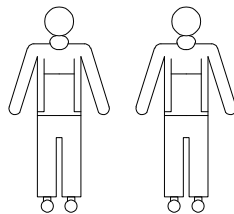

Minimum no. 2 of people
recommended to assemble
this product: Approx.
assembly time: 60 mins

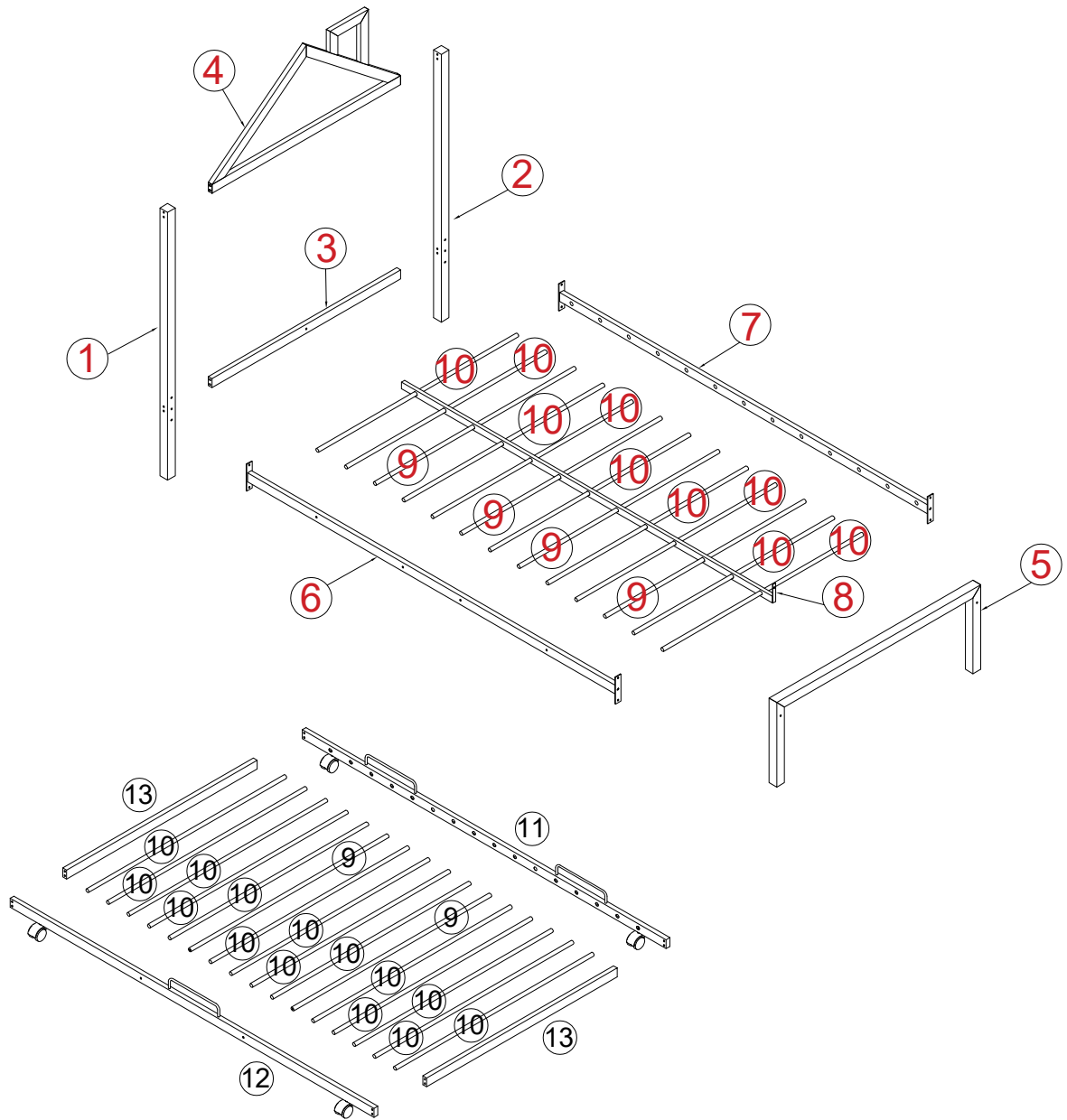





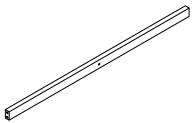
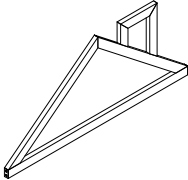
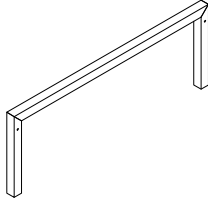
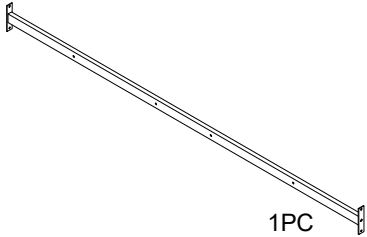
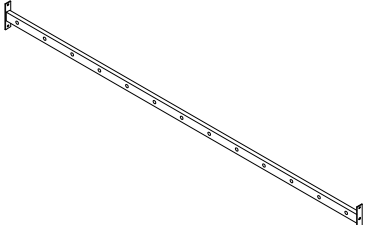
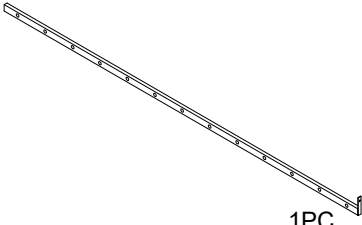
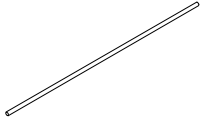
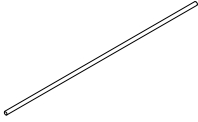
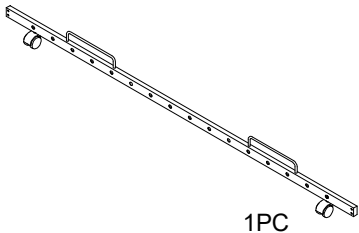
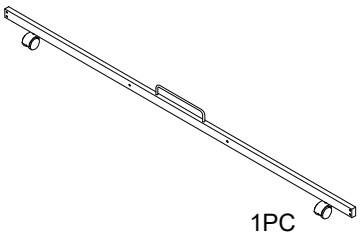
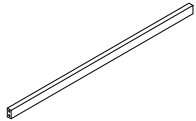



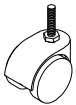

PART LIST MF320583

<p>1</p>  <p>1PC</p>	<p>2</p>  <p>1PC</p>	<p>3</p>  <p>1PC</p>
<p>4</p>  <p>1PC</p>	<p>5</p>  <p>1PC</p>	<p>6</p>  <p>1PC</p>
<p>7</p>  <p>1PC</p>	<p>8</p>  <p>1PC</p>	<p>9</p>  <p>6PCS</p>
<p>10</p>  <p>23PCS</p>	<p>11</p>  <p>1PC</p>	<p>12</p>  <p>1PC</p>
<p>13</p>  <p>2PCS</p>		

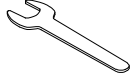
HARDWARE LIST MF320583

<p>A</p>  <p>12PCS M$\frac{1}{4}$"X55</p>	<p>B</p>  <p>9PCS M$\frac{1}{4}$"X35</p>	<p>C</p>  <p>21PCS M$\frac{1}{4}$"X15</p>	<p>D</p>  <p>4PCS #40x40x16</p>
<p>E</p>  <p>2PCS M8xØ50x70H</p>	<p>F</p>  <p>2PCS M8xØ50x70H</p>	<p>G</p>  <p>1PC M4X23X57</p>	<p>H</p>  <p>1PC 13mm</p>

STEP 1

A	D
	
M $\frac{1}{4}$ "x55	#40x40x16
8 PCS	2 PCS

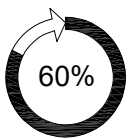
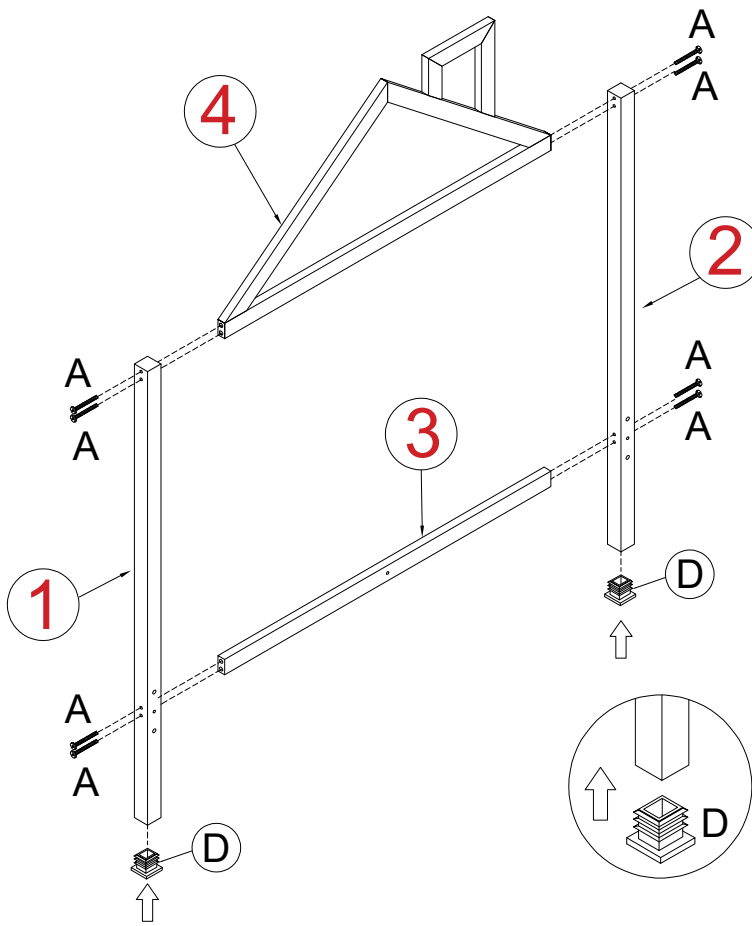



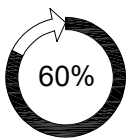
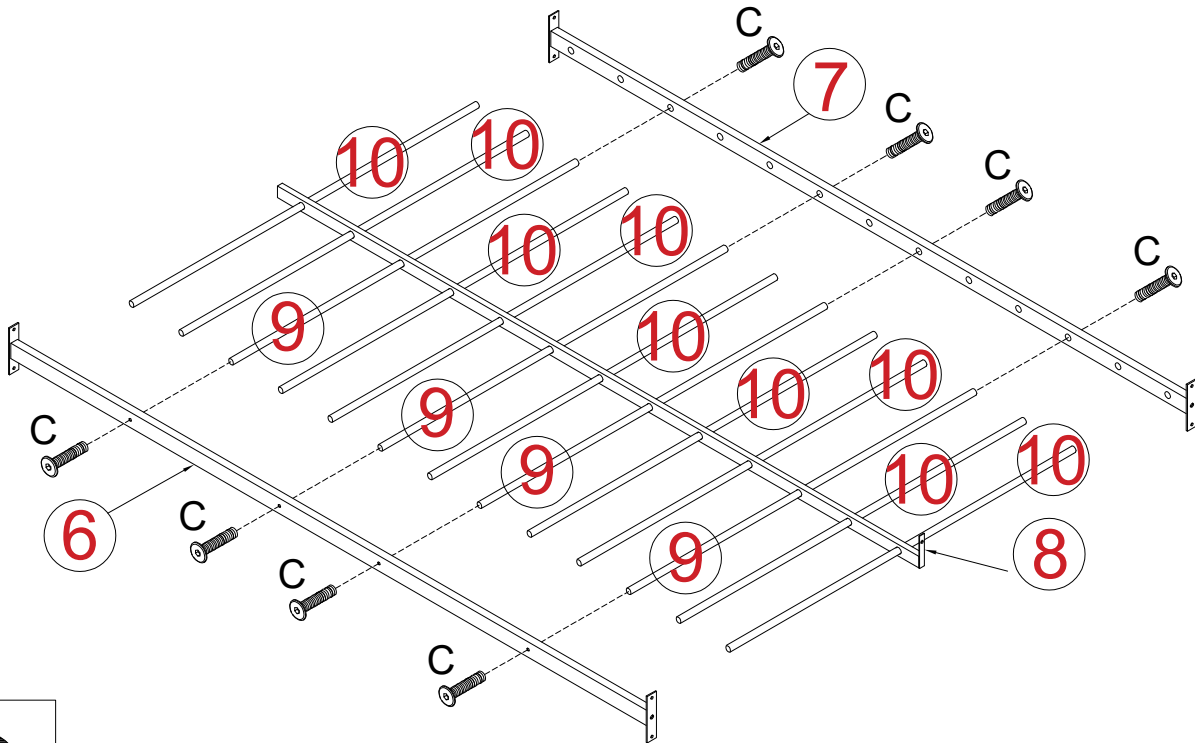

STEP 2

C

M $\frac{1}{4}$ "x15
8 PCS



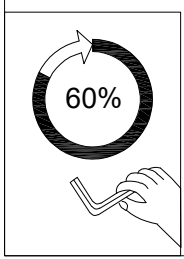
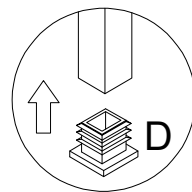
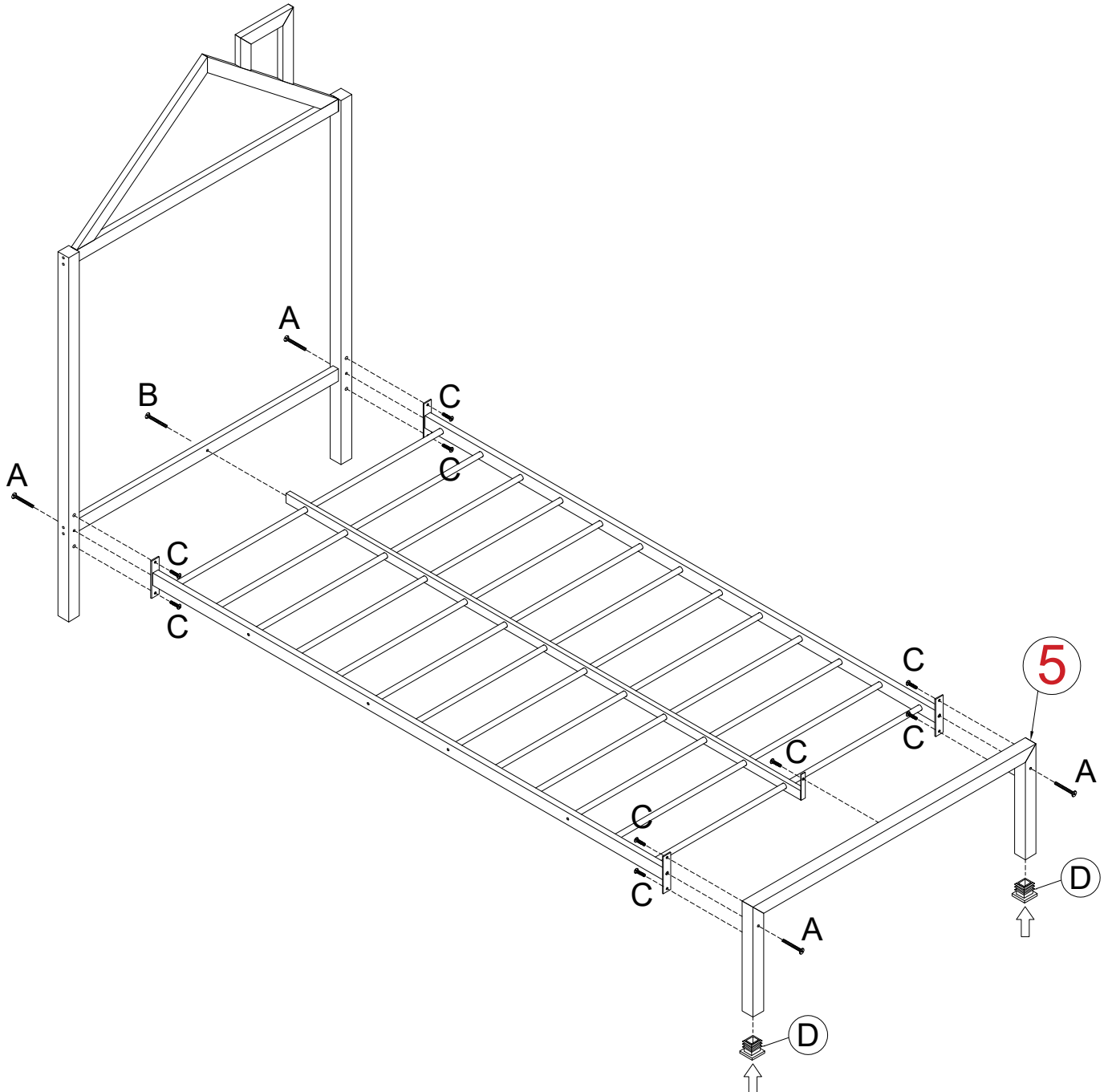

STEP 3

A	B	C	D
			
M $\frac{1}{4}$ "x55	M $\frac{1}{4}$ "x35	M $\frac{1}{4}$ "x15	#40x40x16
4 PCS	1 PC	9 PCS	2 PCS



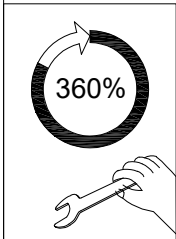
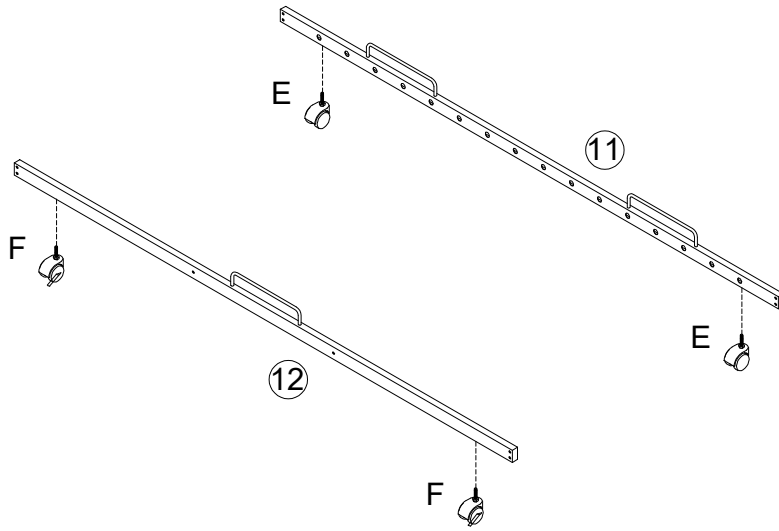

STEP 4

E	F
 M $\frac{5}{16}$ "xØ50x70H	 M $\frac{5}{16}$ "xØ50x70H
2 PCS	2 PCS



STEP 5

B	C
 M $\frac{1}{4}$ "x35	 M $\frac{1}{4}$ "x15
8 PCS	4 PCS

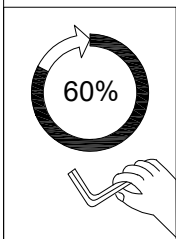
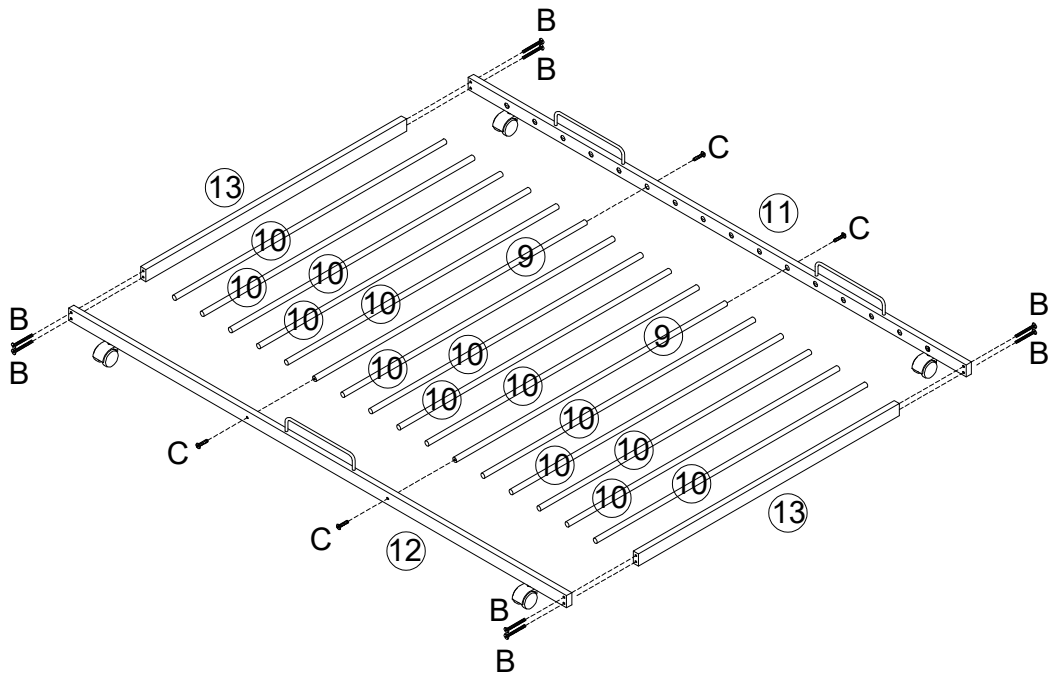

STEP 6

