

IMPORTANT!! PLEASE READ ENTIRE INSTRUCTION SHEET BEFORE ASSEMBLY!!

3pc Bistro Set-CHAIR

Identify all parts packed in the carton against the parts list. Remove all protective materials. Place parts on a non-abrasive surface. If you are missing any parts or Are unsure how to proceed with assembly, please call customer service center

Do not attempt to assemble the product if any parts are missing or damaged .

Step 1

Place right chair seat frame (A) on a flat, soft surface.

Attach swivel chair T-Rocker (B) to the swivel chair frame by using bolts (D) with steel plate (G), locker washer (F), and nut (E) through each hole of the swivel chair seat frame into the swivel chair T-Rocker (B).



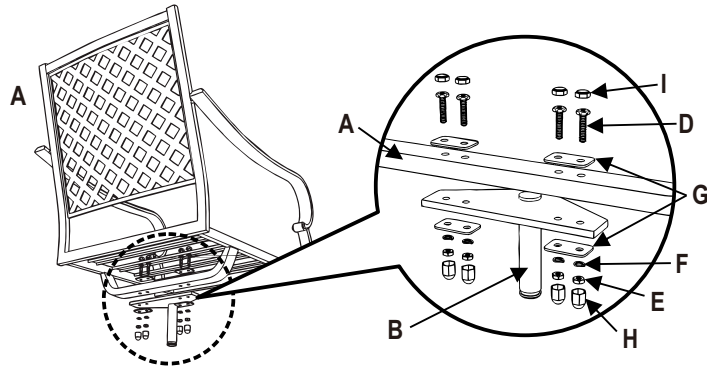





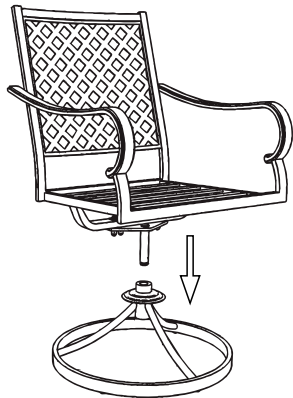



Tighten all bolts with the Hex wrench (J). Cover all bolts (D) and nuts (E) with the plastic caps (H) & (I).



Step 2

Insert the upper chair frame to chair base (C) by using a twisting motion as you insert.



| PARTS LIST | | | | | | | |
|------------|-------------------------|---|---|---|-----------------------|---|---|
| A | SWIVEL CHAIR SEAT FRAME |  | 1 | B | SWIVEL CHAIR T-ROCKER |  | 1 |
| C | SWIVEL CHAIR BASE |  | 1 | D | BOLT(M8*45) |  | 4 |
| E | M8 NUT |  | 4 | F | LOCKER WASHER |  | 4 |
| G | STEEL PLATE |  | 4 | H | M8 MUT PLASTIC CAP |  | 4 |
| I | M8 PLASTIC CAP |  | 4 | J | HEX WRENCH |  | 1 |
| K | BACK CUSHION |  | 1 | L | SEAT CUSHION |  | 1 |

Step 3

Place the cushions (K&L) on the seat.

Now is ready for your enjoyment.

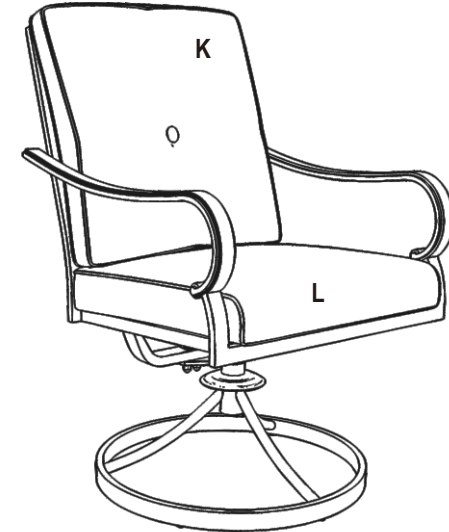

IMPORTANT!! PLEASE READ ENTIRE INSTRUCTION SHEET BEFORE ASSEMBLY!!

3pc Bistro Set-TABLE

Identify all parts packed in the carton against the parts list. Remove all protective materials. Place parts on a non-abrasive surface. If you are missing any parts or Are unsure how to proceed with assembly, please call customer service center





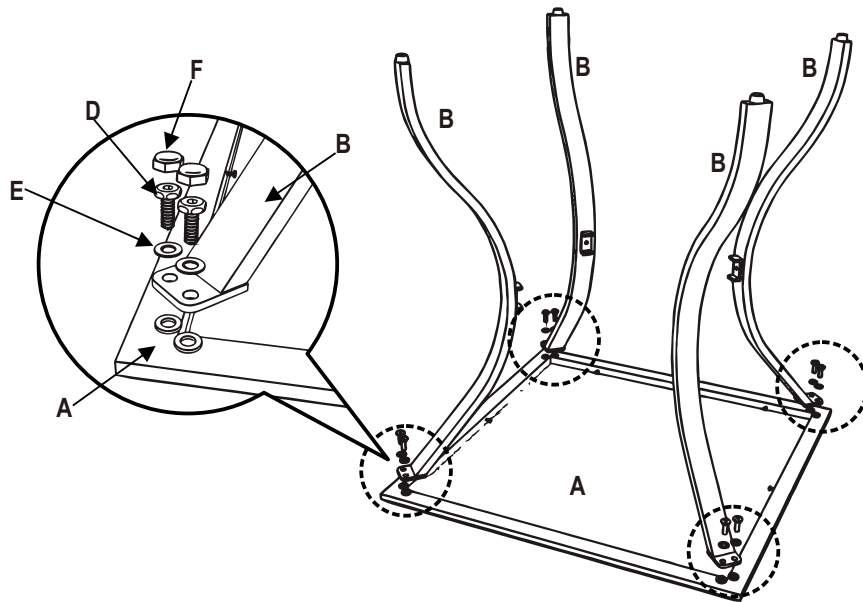

Do not attempt to assemble the product if any parts are missing or damaged .

Step 1

Place table top (A) upside down on a flat, soft surface.

Attach the table legs (B) to table top (A) by inserting bolts (D) with washer (E) through the pre-drilled holes in the table top and legs.



| PARTS LIST | | | | | | | |
|------------|-------------------|---|----|---|-------------|---|----|
| A | TABLE TOP |  | 1 | B | TABLE LEG |  | 4 |
| C | TABLE SUPPORT RIM |  | 1 | D | BOLT(M6*20) |  | 12 |
| E | METAL WASHER |  | 12 | F | CAP |  | 12 |
| G | ALLEN WRENCH |  | 1 | | | | |

Step 2

Attach the table support rim (C) to table legs (B) by using bolts (D) with washer (E) through the pre-drilled holes in the table support tray and legs.

Tighten all bolts (D) with the Allen wrench (J). Cover all bolts with the plastic caps (F). Now is ready for your enjoyment.

