









# Assembly Instructions

**Caution : You must read this before you proceed**

## Care & Maintenance



-  ● Not for commercial use. For residential use only.
  -  ● Furniture may scratch floors. We recommend using furniture pads to protect your floors.
  -  ● Do not put hot items directly on furniture surface.
  -  ● Do not clean furniture with harsh cleansers or polish.
  -  ● Do not place furniture under direct sunlight.
  -  ● Do not place furniture near heating or cooling vents.
  -  ● Do not write on furniture without a padded barrier to protect the surface.
  -  ● Do not place furniture outside . For indoor use only.
  -  ● Stains may be removed with mild soap solution and damp cloth.
  -  ● Children should not climb or jump on the furniture.
- 
-  ● Dust and pick-up spills using a clean, non-colored, lint-free cloth.

Please look in carton for hardware packs and legs.  
Sets often ship in multiple boxes and may arrive a day or two apart.

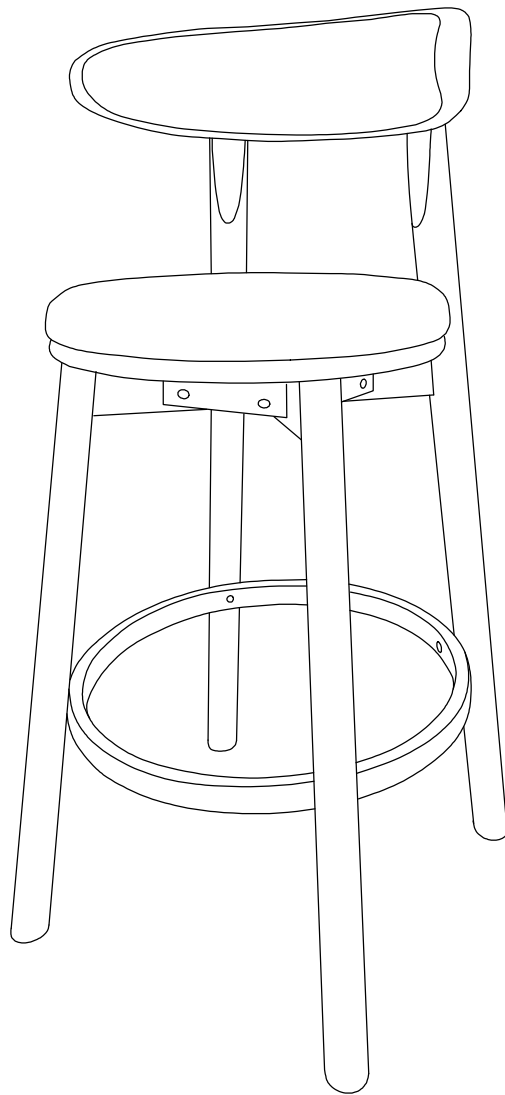

# COUNTER STOOL

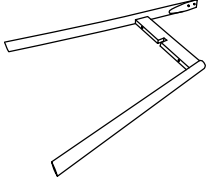
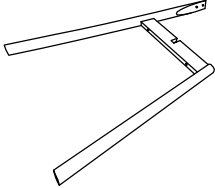
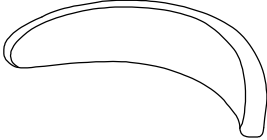
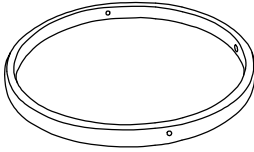
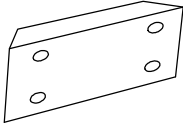

## Parts List

| Label | Picture                                                                             | Description        | QTY |
|-------|-------------------------------------------------------------------------------------|--------------------|-----|
| A     |    | LEG<br>FRAME A     | 1   |
| B     |    | LEG<br>FRAME B     | 1   |
| C     |    | BACK<br>REST       | 1   |
| D     |  | ROUND<br>STRETCHER | 1   |
| E     |  | LEG<br>SUPPORT     | 4   |
| F     |  | SEAT               | 1   |

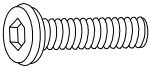
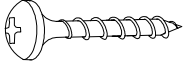
## Parts List

| Label | Picture                                                                           | Description                | QTY  |
|-------|-----------------------------------------------------------------------------------|----------------------------|------|
| 1     |  | JCBC SCREW<br>(M6*35MM)    | 8+1  |
| 2     |  | PANHEAD SCREW<br>(M4*25MM) | 16+1 |
| 3     |  | CSK SCREW<br>(M4*32MM)     | 4+1  |
| 4     |  | ALLEN KEY<br>(M4)          | 1    |

# Assembly Preparation

Before  
Beginning  
Assembly :

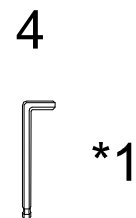
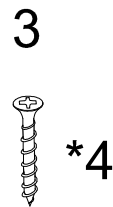
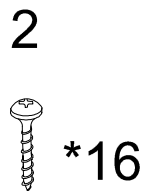
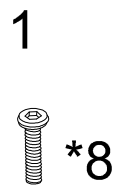
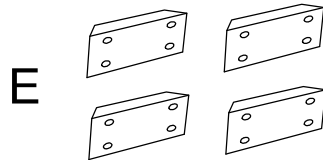
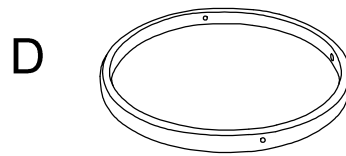
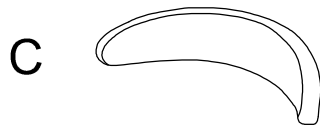
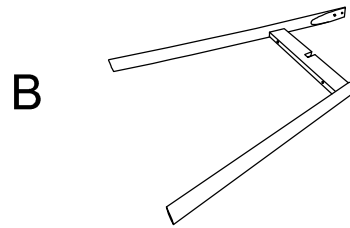
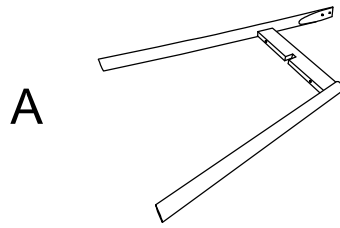

- Read instructions, cover to cover.
- Have 2 adults on hand for assembly.
- Do not assembly on flooring or carpet.
- Assembly on a clean non-marring surface (packing foam).
- Save all packaging until finished.

# Assembly Steps

## Overview

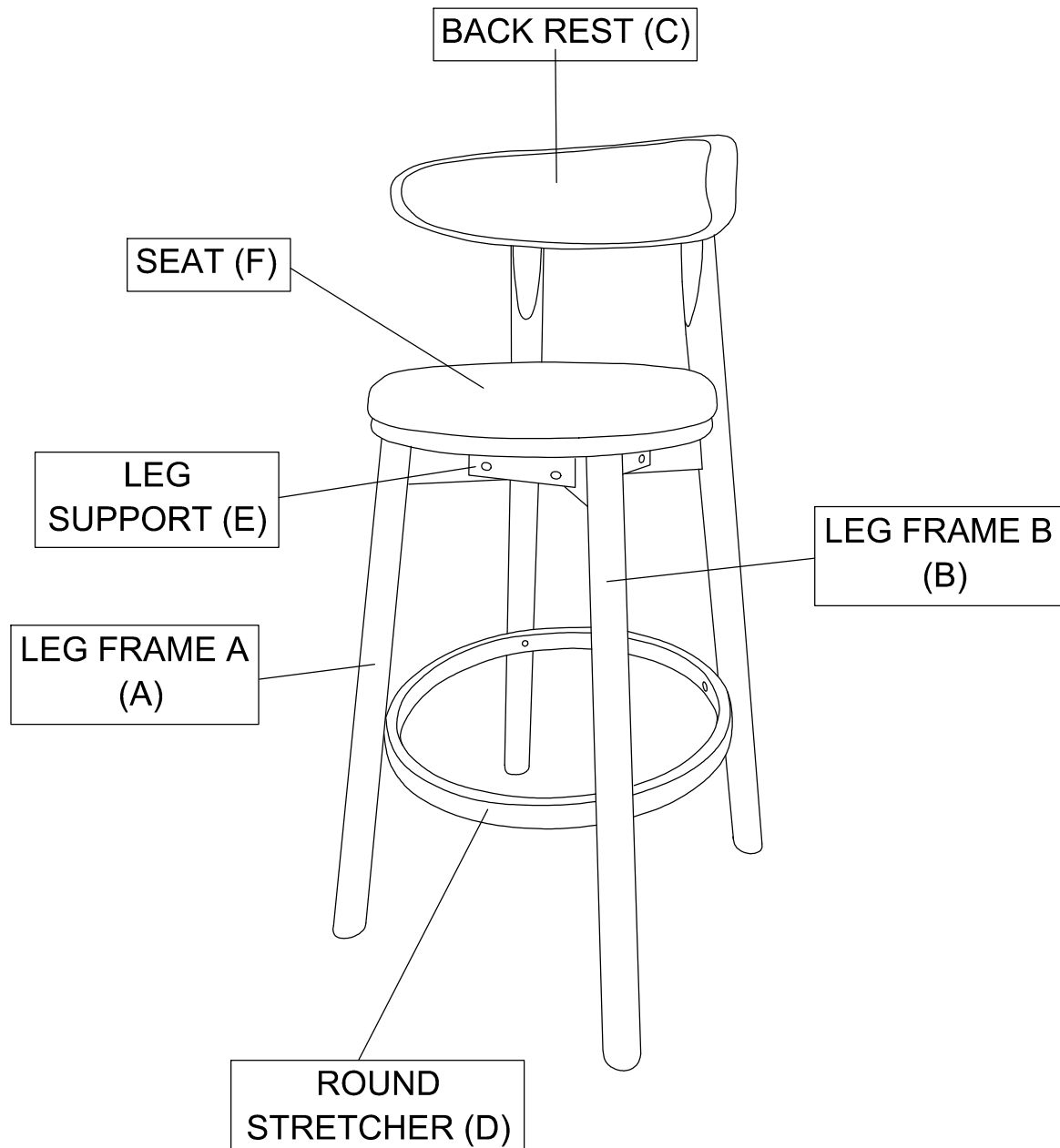

This Counter Stool has multiply parts.

To give an overview of the Counter Stool, the above picture is to help you put the various parts into perspective.

Please read through the instructions below to familiarise yourself with the parts and steps before assembly.

**Note: it is recommended that you have an adult partner to assist during the entire assembly process.**

Step 1

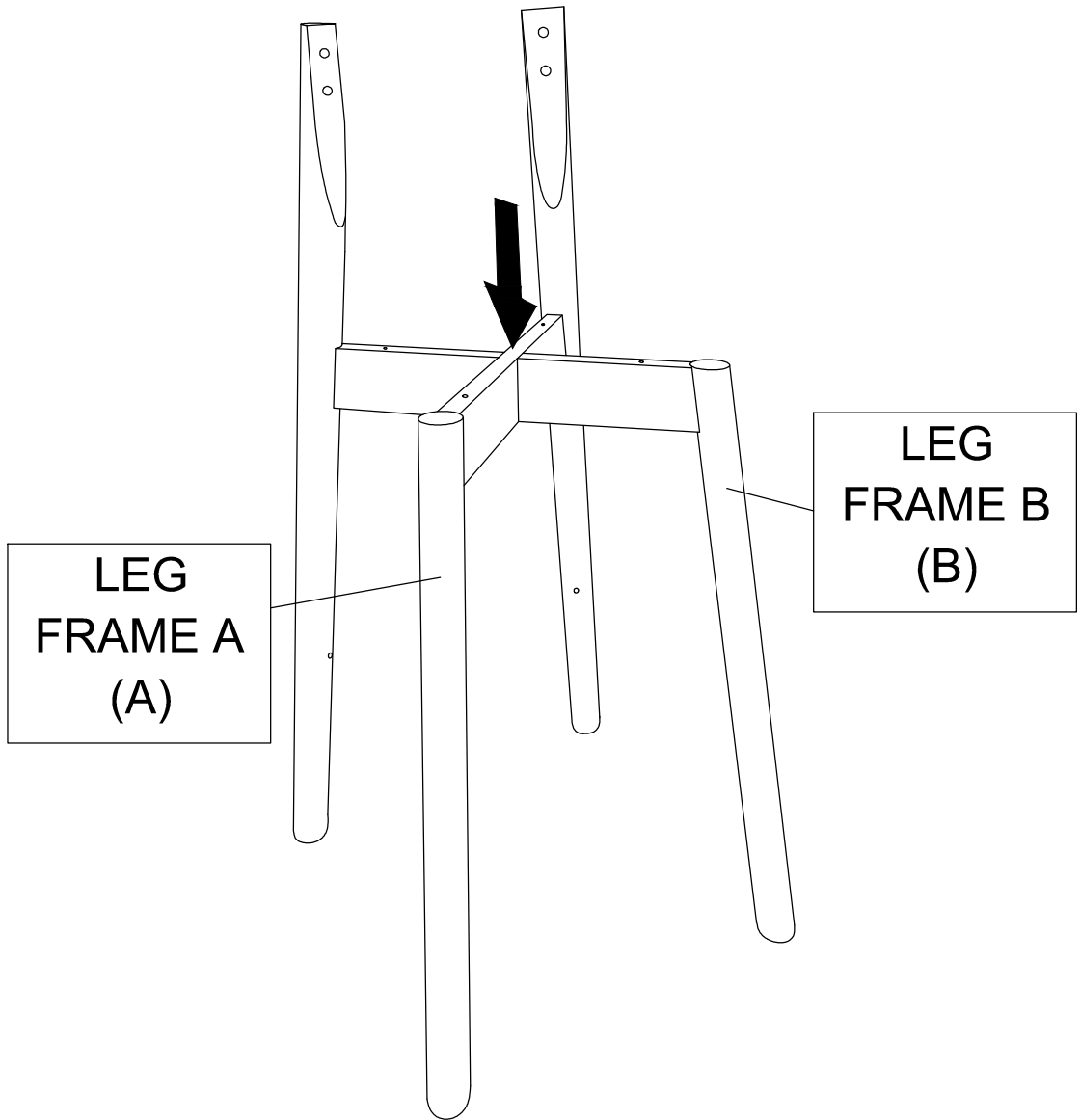

Open the carton and place all parts onto a clean, non-marring surface. Insert Leg Frame A (A) into the slot on Leg Frame B (B).

Step 2

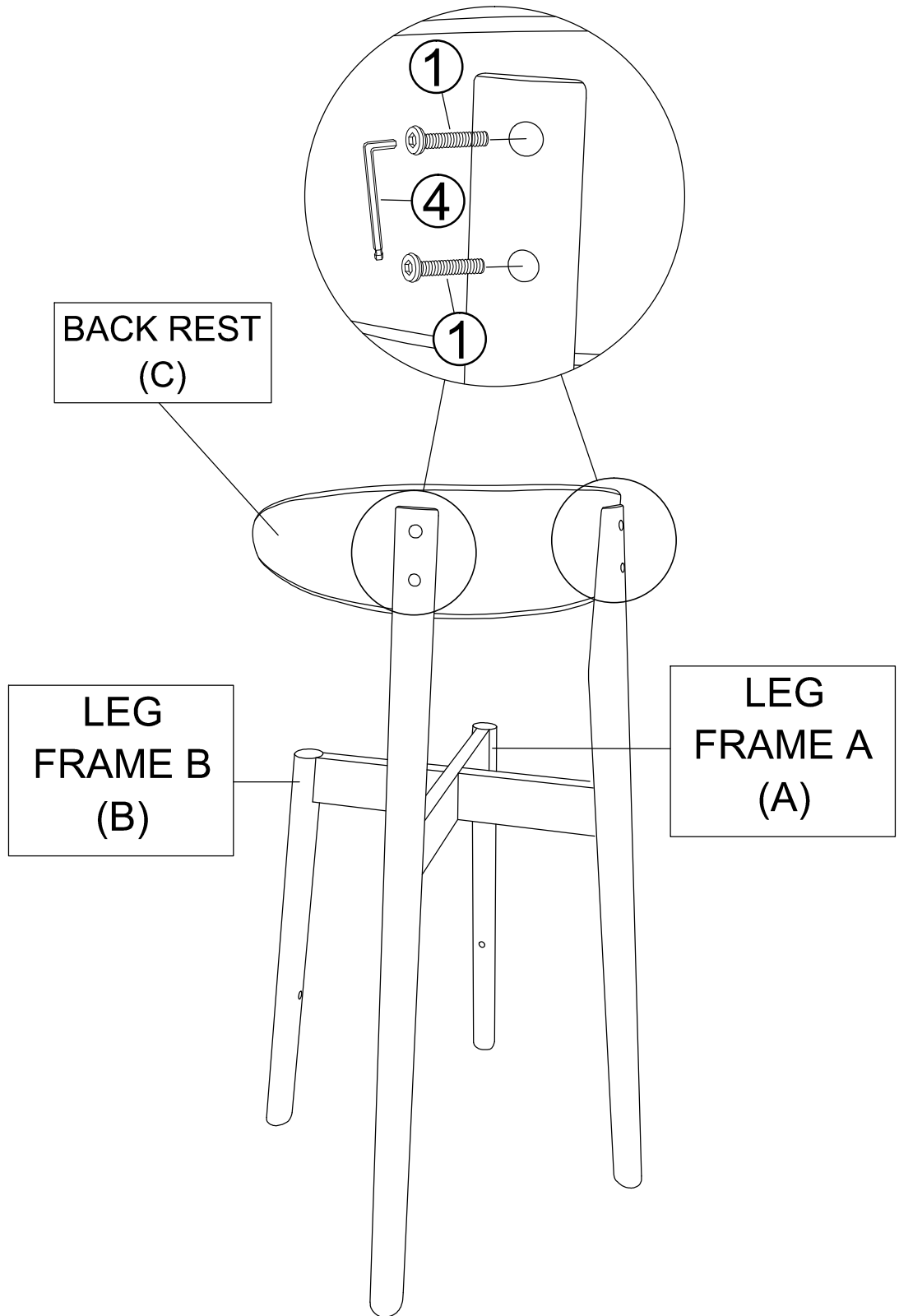

Use Allen Key (4) to secure Back Rest (C) to Leg Frame A (A) and Leg Frame B (B) with Jcbc Screw (1).

Step 3

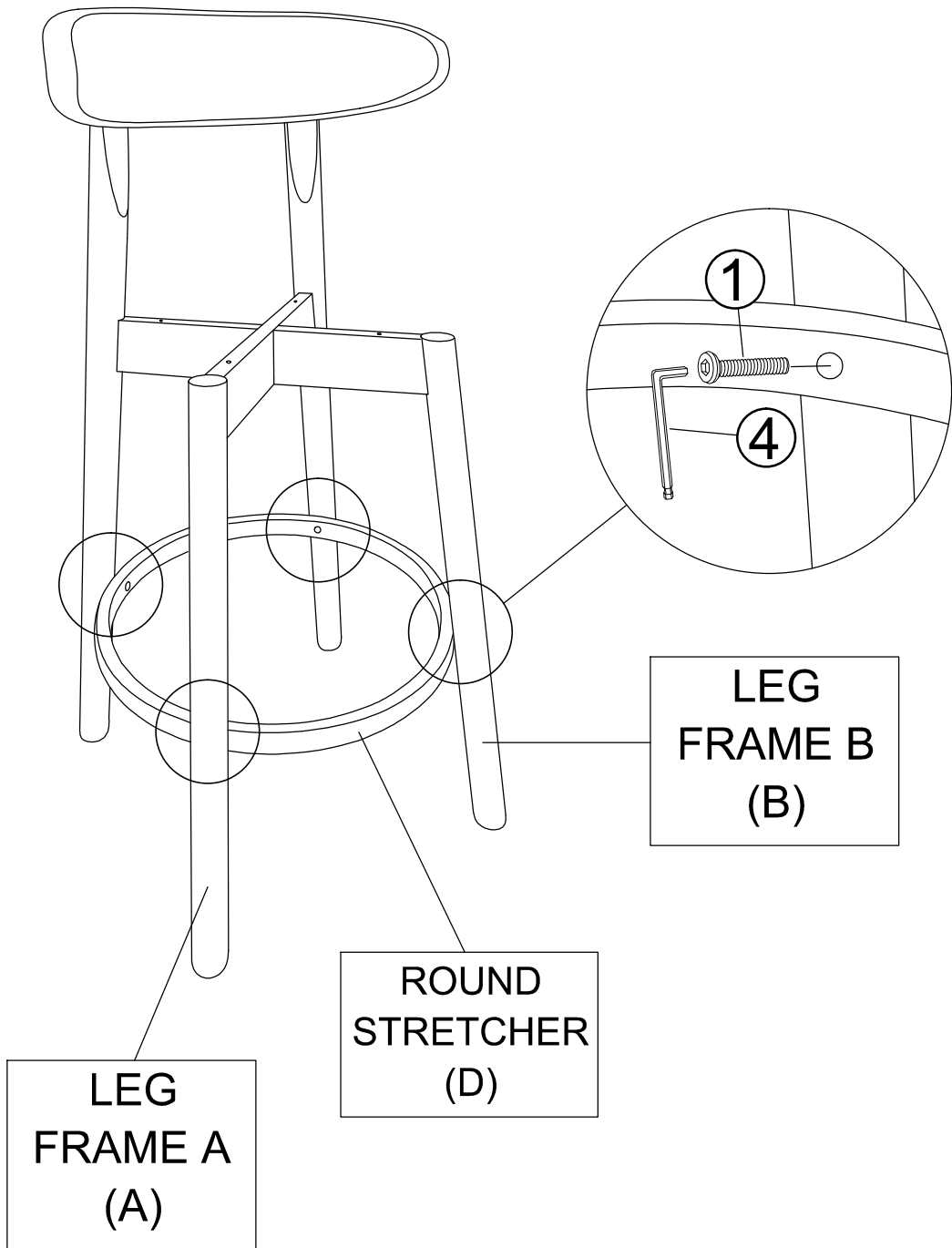

Use Allen Key (4) to secure Round Stretcher (D) to Leg Frame A (A) and Leg Frame B (B) with Jcbc Screw (1).

Step 4

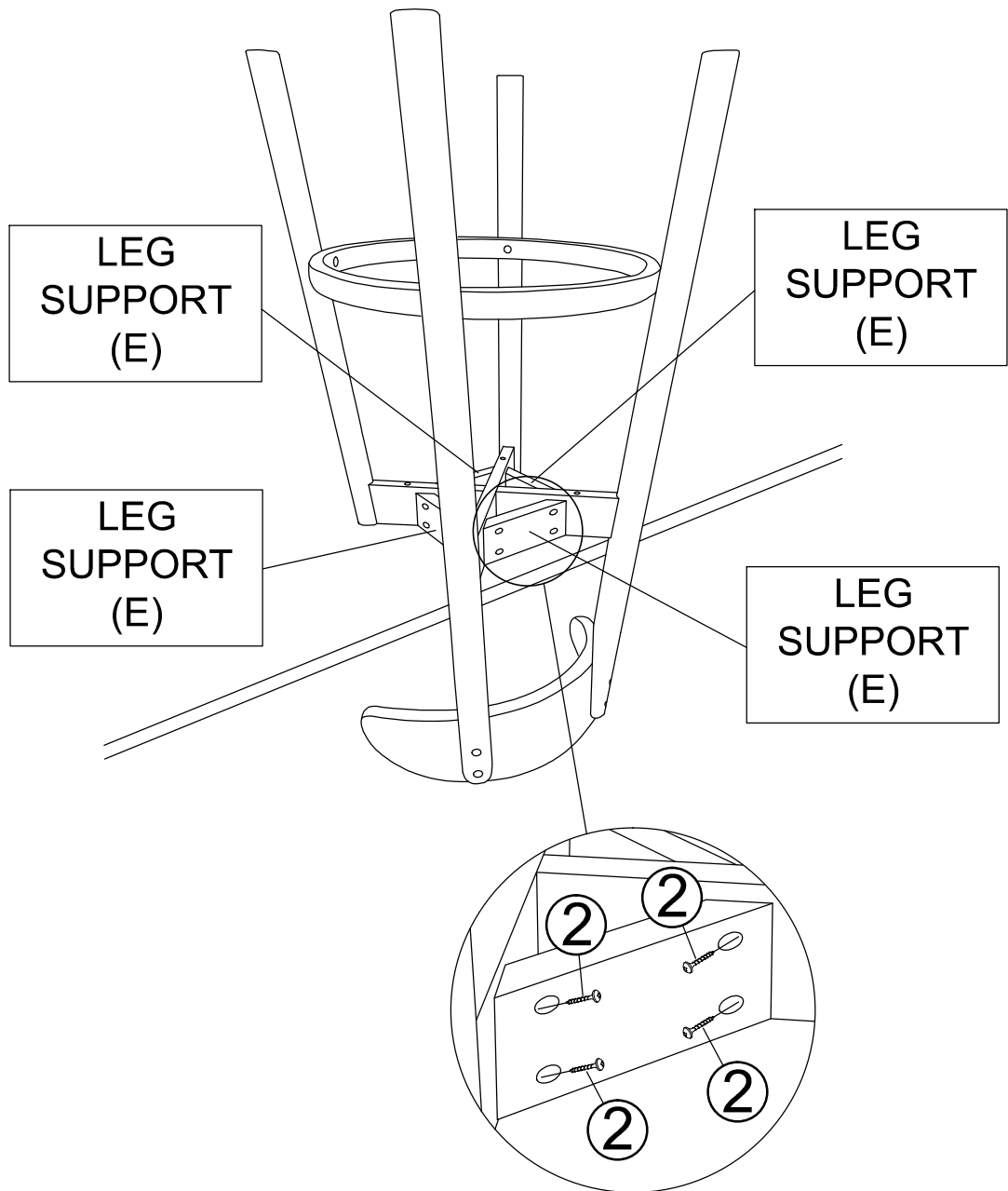

Secure Leg Support (E) to Leg Frame A (A) and Leg Frame B (B) using Panhead Screw (2).

Step 5

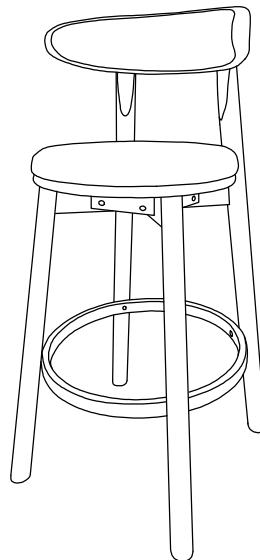
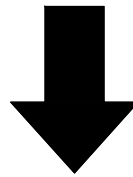
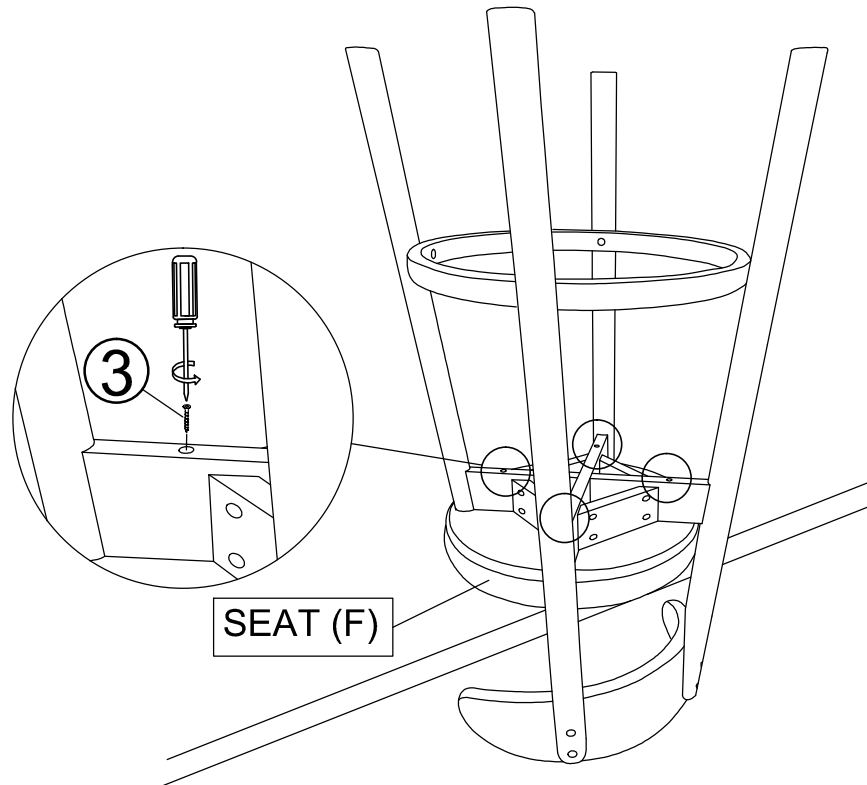

Secure Seat (F) to Leg Frame A (A) and Leg Frame B (B) using Csk Screw (3). Your counter stool is ready to use.

**This counter stool can only use on a flat, level surface.**