

Assembly Instructions

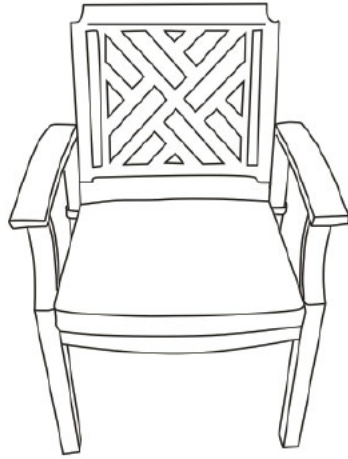



Caution: You must read this before you proceed

Chair



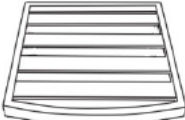

Caution: This Chair is NOT a TOY.
Keep your child/children at bay during the assembly process.

Part List

Label	Picture	Description	QTY
A		Backrest Panel	1
B		Chair Seat Panel	1
C		Right Leg with Arm	1
D		Left Leg with Arm	1
E		Cushion	1

Hardware

Label	Picture	Description	QTY
①		Bolt (M6*30mm)	5
②		Bolt (M6*50mm)	5
③		Allen Key	1

Assembly Preparation

Before beginning assembly:

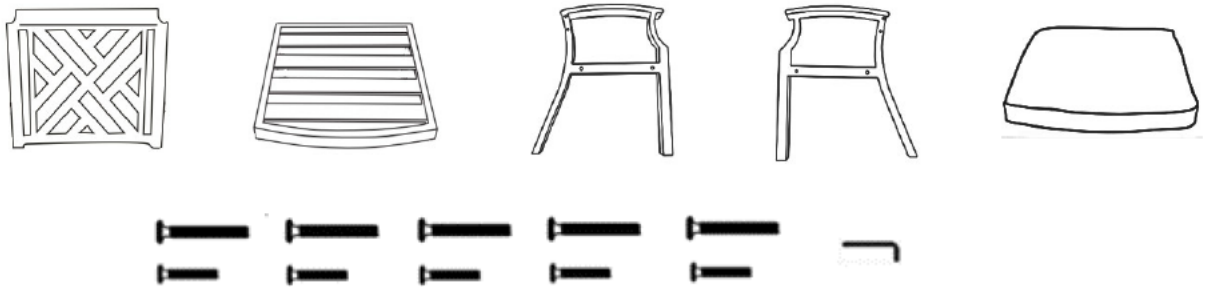

- Read instructions, cover to cover-



- Have 2 adults on hand for assembly-



- Do not assemble on flooring or carpet-



- Assemble on a clean non-marring surface (packing foam)-



- Save all packaging until finished-

Assembly Steps

Overview

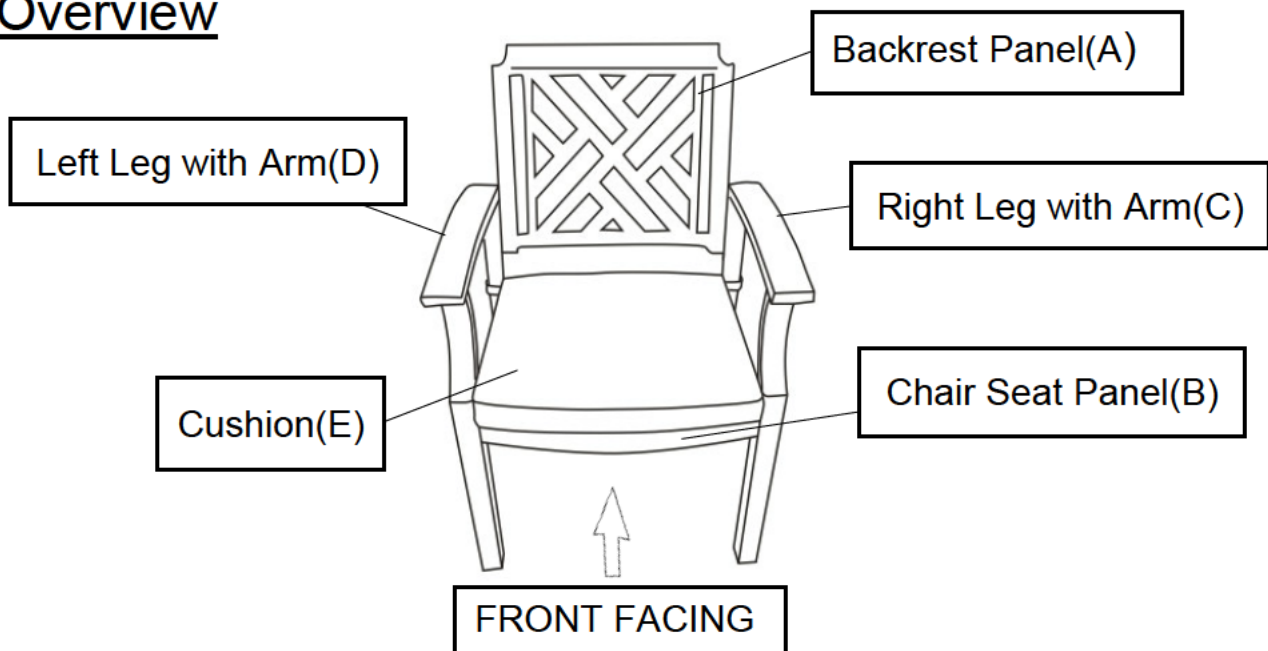

This Chair has multiple parts and may require up to 30 minutes to assemble. To give you an overview of the Chair parts, the above picture is to help you put the various parts into perspective. Please read through the instructions below to familiarise yourself with the parts and steps before assembly.

Step 1



Unpack and place all parts on a clean, non-marring surface.

Step 2

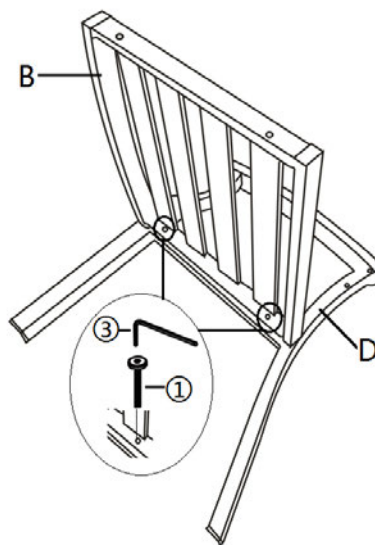

Attach Chair Seat Panel(B) to Left Leg with Arm(D) using Bolts(①) with Allen Key(③).

Do not fully tighten the Bolts.

Step 3

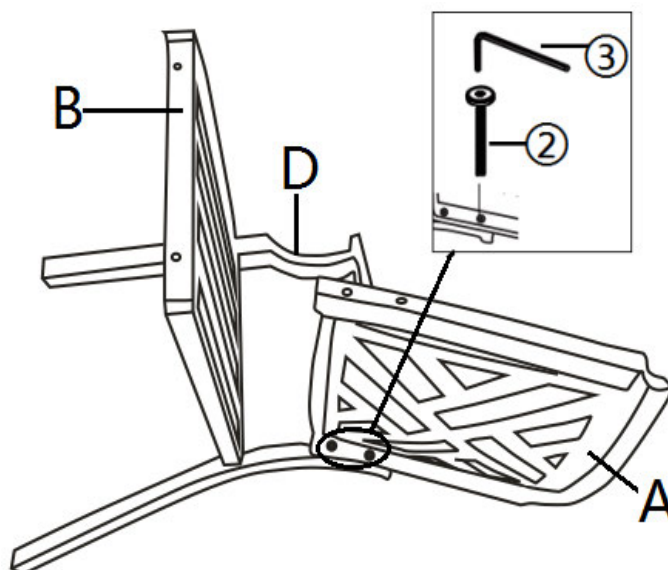

Attach Backrest Panel(A) to the Left Leg with Arm(D) using Bolts(②) with Allen Key(③).

Do not fully tighten the Bolts.

Step 4

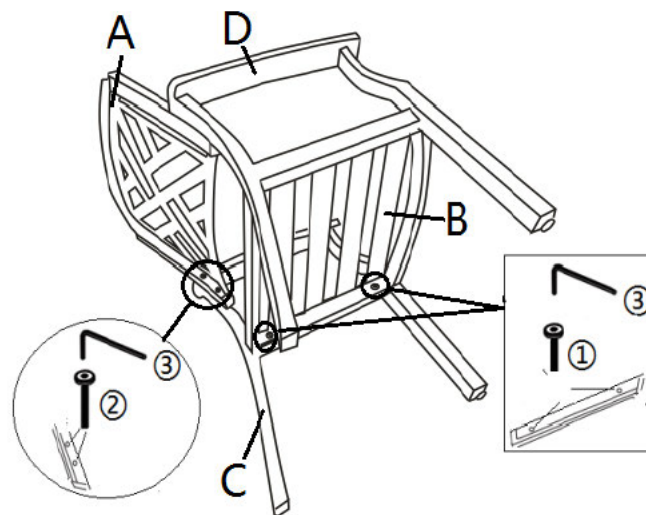

Attach Right Leg with Arm(C) to Backrest Panel(A) and Chair Seat Panel(B) using Bolts(①), and Bolts(②) with Allen Key(③).

Do not fully tighten the Bolts.

Step 5

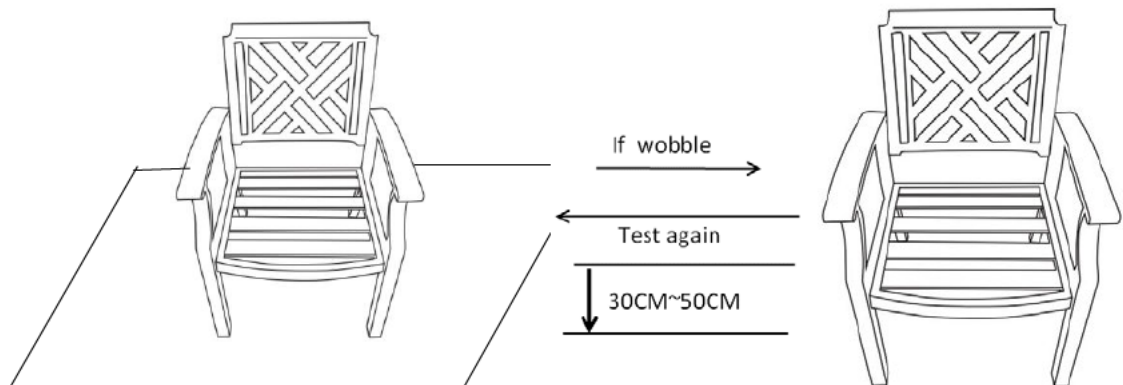

Stand the Chair up.

Place the Chair on a LEVEL SURFACE to see if it wobbles.

Noted: Need tighten the Pre-attached Levellers under chair legs.

If it wobbles, lift the Chair some 30cm to 50cm high from the ground.

Keep your feet and toes well away from the drop zone.

Drop the Chair freely and vertically with the four legs, hitting the ground, at the same time.

This Drop Test will help to ensure that all the Bolts and gaps all reach full alignment status.

Test again for evenness on a LEVEL SURFACE.

If no wobbles are found, proceed to tighten all the Bolts.

When tightening the Bolts, tighten sequentially.

DO NOT tighten any Bolt fully and then move on to the next one.

If there are still wobbles, loosen the Bolts and execute the same drop test.

If the Chair is not stable it could lead to damage to the product.

Step 6

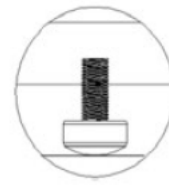
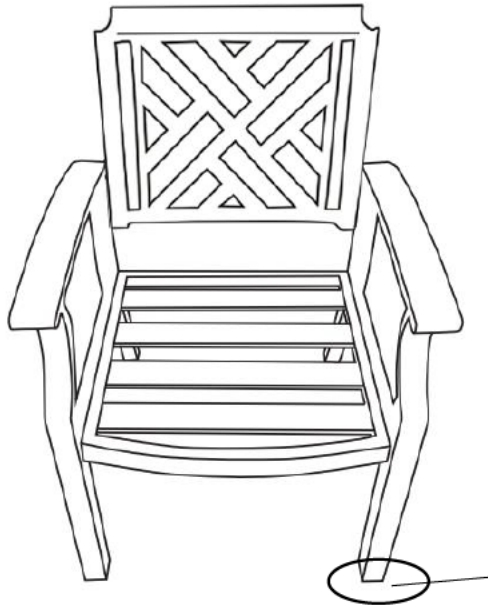

Adjust height
for balance

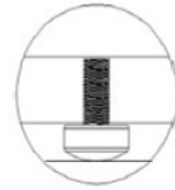

Adjust low for
balance

Adjust Pre-installed
Levellers
height for balance

Adjust the Pre-attached levellers at the bottoms of the chair legs until the chair is level with the ground.



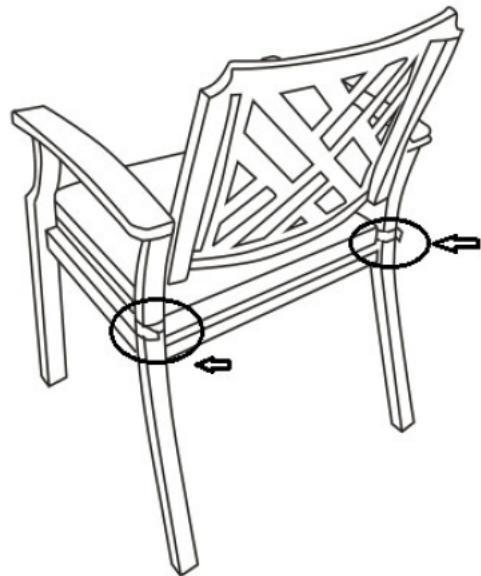
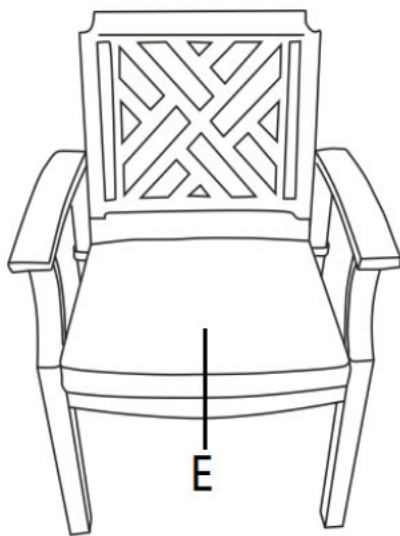















Step 7



Place the Cushion(E) on the Chair and secure the straps around the Legs.
Your Chair is ready for use.

This Chair can only be used on a flat, level surface.

Care & Maintenance

-   • Do not put hot items directly on furniture surface.
 -   • Do not clean furniture with harsh cleansers or polish.
 -   • To obtain the longest lifespan of your outdoor products, minimizing exposure to direct sunlight is recommended.
 -   • Children should not climb or jump on the furniture.
 -   • Do not write on furniture without a padded barrier to protect the surface.
 -   • To obtain the longest lifespan of your outdoor products, avoid extended and lengthy exposure to rain, snow, and direct sunshine. Whenever possible cover the product and /or place under patio or awnings.
 -   • Not for commercial use. For residential use only .
 -   • Stains may be removed with mild soap solution and damp cloth.
-
-   • Dust and pick-up spills using a clean, non-colored, lint-free cloth .