

Assemble Instruction

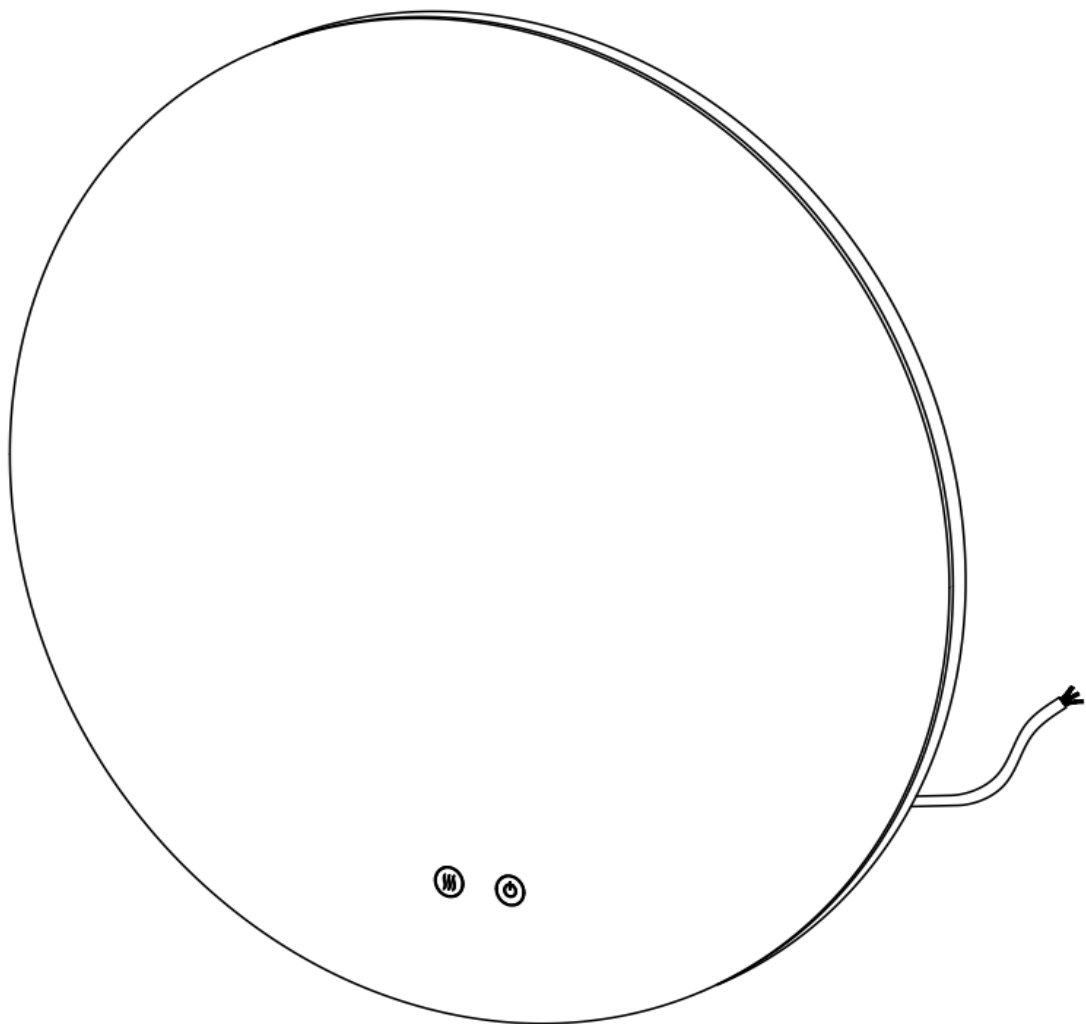

SKU: YC6060

SIZE: 24*24 inch

LED Wall Mount Mirror

Thank you for purchasing this product. If you have any questions, please contact our customer service department. We are always willing to help you.



Important Notices:

1. Please make sure all parts are included. When taking all parts out, please put them on a soft surface to prevent scratches.
2. As this product is made of metal, the edges and corners are sharp, please protect yourself from scratching during installation.
3. When working at height, please choose a safe platform to operate.
4. Please make sure there are no hidden cables or pipes before drilling.
5. Wear a pair of safety goggles when drilling.
6. Be careful when using power tools near water.

Wall Types:

1. Fixtures provided are usually used for solid walls.
2. If mount it on a tile, please use a ceramic drill and insert a wall plug under the tile.

Accessories includes:

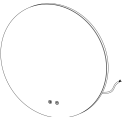
Typ	Draw	Number	Name
1		2PCS	Metal screws
2		2PCS	Rubber plug screws
3		1PC	LED Wall Mount Mirror

Tools needed:

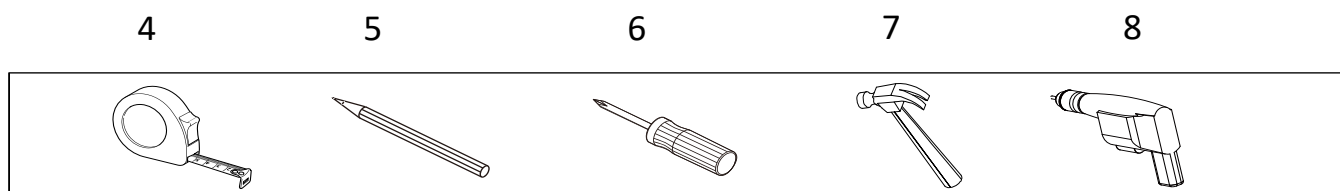

Installation Steps:

1. Determine installation location

Please mark the hole location on the wall according to the hole spacing on the back of the frame mirror. Then, drilling the hole according to the mark location and install the glue plug screw into the holes. Please install at least 2 screws or more to make sure the frame mirror is stable.

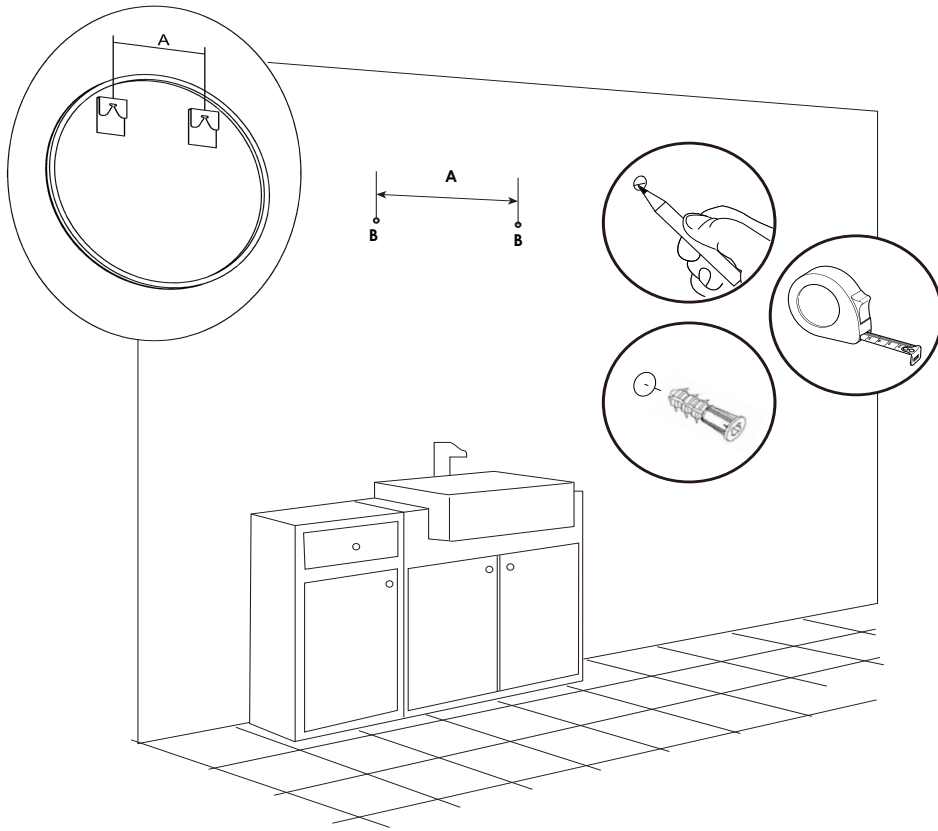

2		2PCS
4		1PC
5		1PC
7		1PC
8		1PC

2. Install the cabinet

Turn the metal screws into the rubber plug screws and leave gaps, then hang the mirror according to the corresponding holes position.

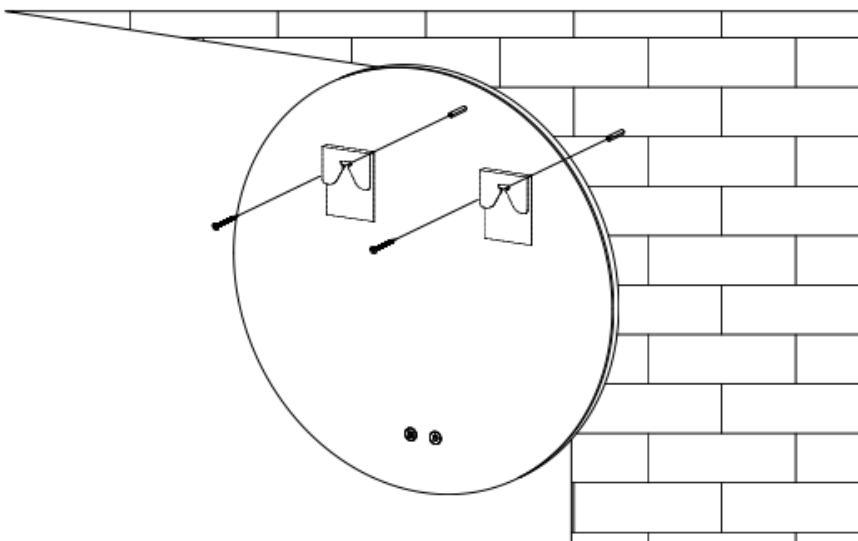

Note:

When mounting to the wall, the wire can not be pressed between the mirror and the wall, otherwise the wire installation will be affected.

1		2PCS
6		1PC

3. Wiring diagram:

Wiring of any lights should be done by a qualified electrician and in accordance with National and Local Electrical Codes. Please buy a suitable plug to connect the wire if necessary.

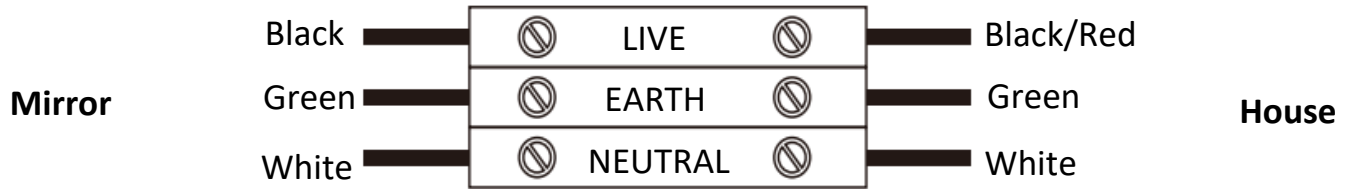

4. Test:

After the installation is completed, please test whether the LED light can be normally used. If not, please check whether the plug wire is successfully installed. Lights up with short press means installation is successful. If there is any problem, please contact the customer service.

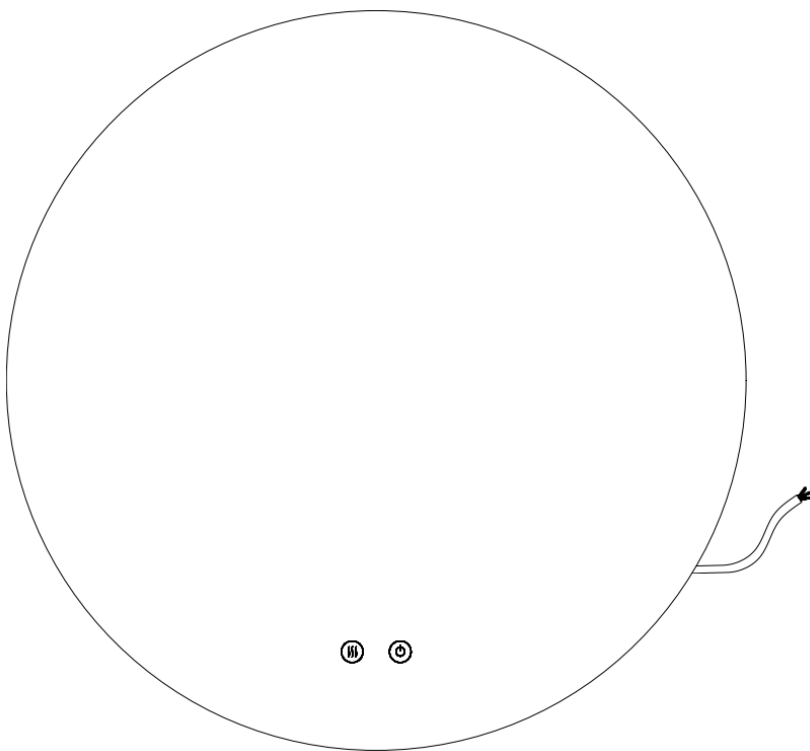

The product's touch switch mode:

1. Short press the switch button to change three colors: cold light , white light , warm light.
2. Long pressing the switch button allows you to adjust the brightness of the light.

 Demister control

 Switch the light on/off