









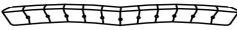

Assembly Instruction

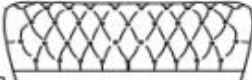
Sofa

PARTS LIST

 A	$\times 4$	 BL	$\times 1$	 BR	$\times 1$		
 C1	$\times 1$	 C2	$\times 1$	 D	$\times 1$	 E	$\times 2$
 F	$\times 2$	 G	$\times 16$	 J		 H	$\times 1$

STEP1

STEP2

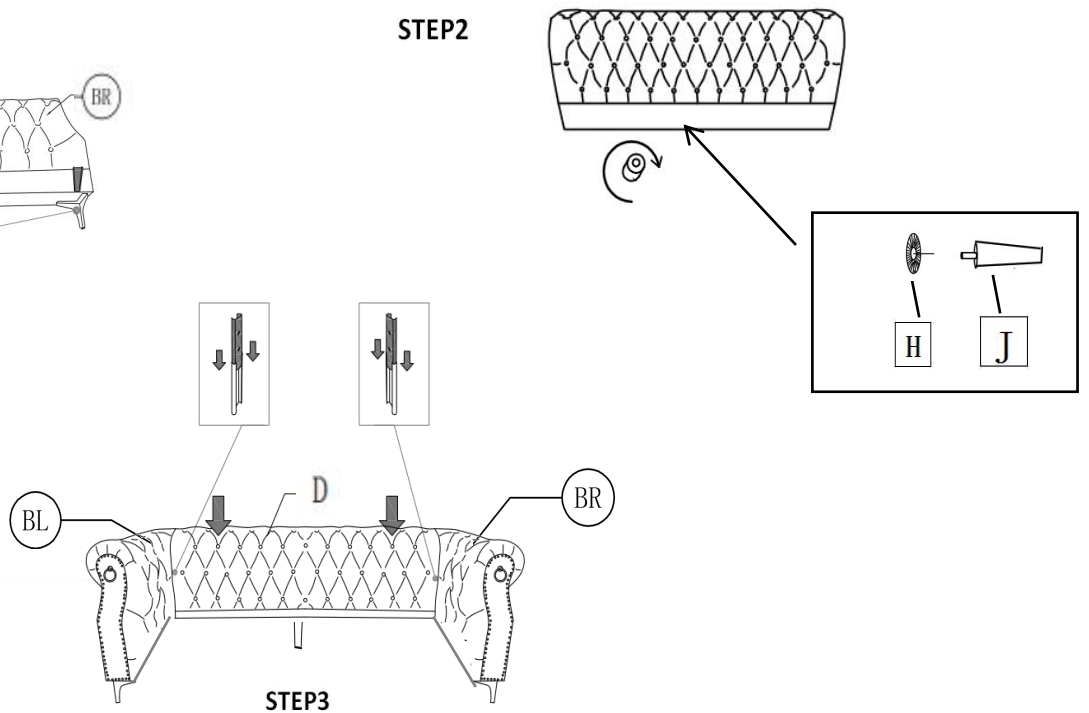
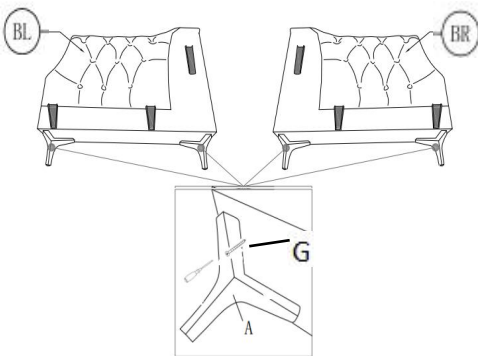

STEP3

STEP4

STEP5

