

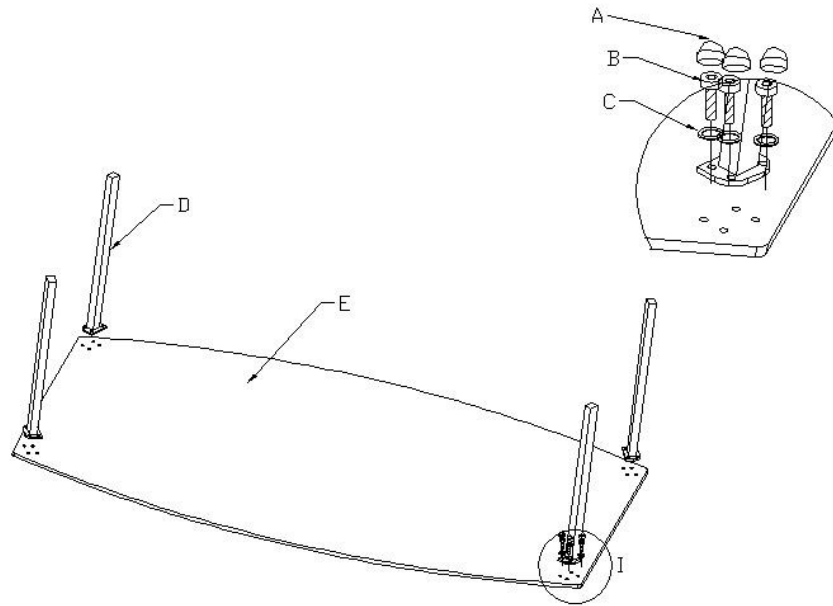





Aufbauanleitung Tisch 150x90cm

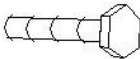

A		16 Stk.
B		16 Stk.
C		16 Stk.
D		4 Stk.
E		1 Stk.
F		1 Stk.

Achtung!

Bitte ziehen Sie die Schrauben erst vollständig an, wenn alle Schrauben in ihrer richtigen Position sind!