

INSTRUCTION MANUAL

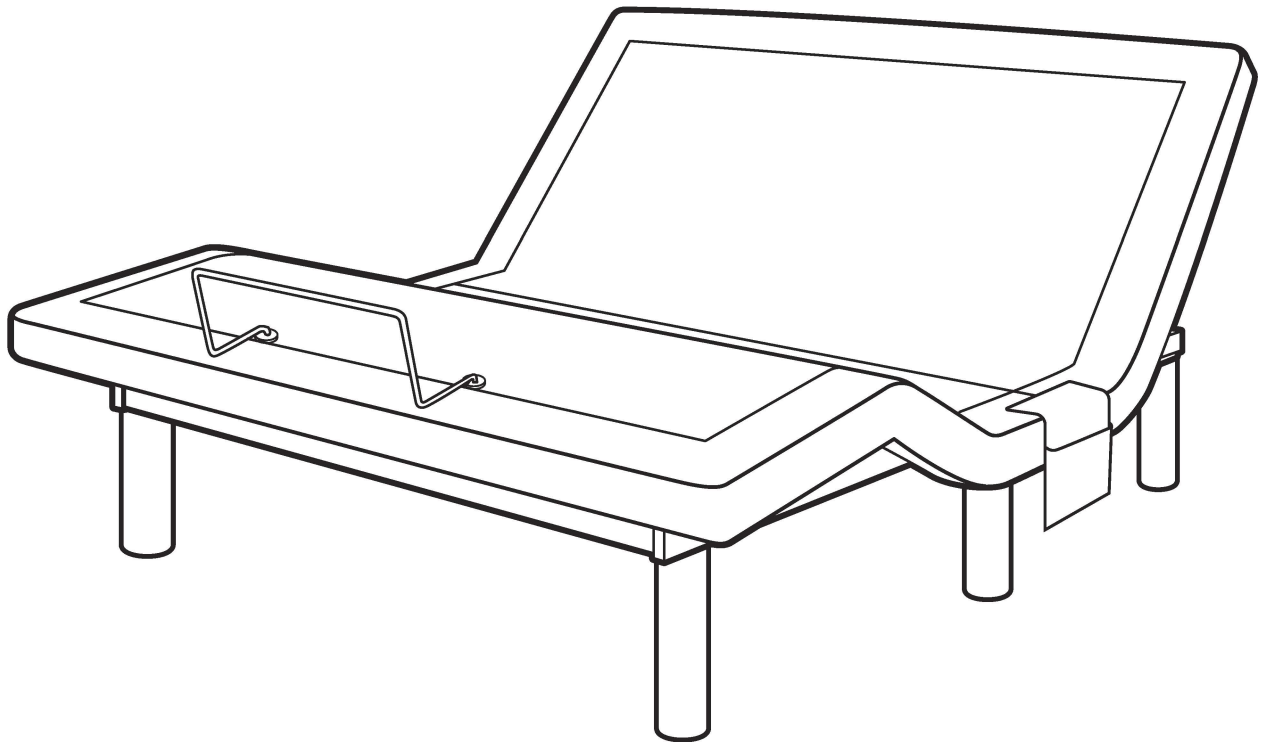

Adjustable Bed Base

CONTENTS

IMPORTANT SAFETY INFORMATION	02
SPECIFICATIONS	04
STANDARD PARTS LIST	04
INSTALLATION STEPS	05
BED BASE DIAGRAM	07
REMOTE CONTROL	08
PAIRING REMOTE	09
PROGRAMMABLE BED POSITION	09
PRESET BED POSITIONS	10
RESET PRESET POSITIONS	11
THE STANDARD BED CONTROL APP	12
SYNCHRONIZING TWO TWIN XL BASES	14
TROUBLESHOOTING	15

IMPORTANT SAFETY INFORMATION

For your safety, please read all instructions carefully before using this adjustable bed base. Save these instructions for future reference.

WARNING

TO REDUCE THE RISK OF BURNS, FIRE, ELECTRIC SHOCK, OR OTHER PERSONAL INJURY:



The product is intended for indoor use only. The product must be assembled and used in accordance with the provisions of the manual. Personal injury and/or damage to the product may occur if products are used outside of their intended purposes and/or if products have been changed/modified from their original design. The seller does not assume any responsibility or liability with respect to any injury/damage caused by incorrect assembly or improper use.



Do not operate this bed if it has a damaged cord or plug, if it is not working properly, if it has been dropped or damaged, or if it has been submerged in water. Please contact customer service for further assistance.



- Unplug from outlet before installing, removing parts, cleaning or servicing.
- Remember to turn all controls to the OFF position before unplugging.



- Close supervision is necessary when the bed is used by or near children or disabled persons.
- DO NOT allow any person or pet under the bed at any time.



Keep the product away from fire sources and high temperatures. DO NOT expose the product to direct sunlight.

DO NOT place any hot objects on the surface of the product.



DO NOT operate where aerosol (spray) products are being used or where oxygen is being administered.



Exercise extra caution when handling liquids in or around the bed. In case of spillage, immediately stand in a dry, clean area of the floor and unplug the bed. Clean up spill and allow the area around bed to dry thoroughly before using the electric controls again. DO NOT eat or drink hot liquids while operating the bed.



Never operate the bed with the air openings blocked. Keep the air openings free of lint, hair, and other obstructions.

IMPORTANT SAFETY INFORMATION

WEIGHT LIMITS

- **Weight Restrictions:** The recommended weight limit for this bed base is 750 lbs / 340kg. The bed will structurally support this weight, provided it is evenly distributed across the foundation. The power foundation is not designed to support or lift this amount in the head or foot sections alone. Exceeding this weight restriction could damage the bed and/or cause injury and will void the warranty.

WARRANTY WARNING

- Any opening or tampering with the control box, motors, or hand controls (with the exception of the battery compartment if equipped) will void the warranty.

PRODUCT RATING

- The motors are not designed to operate continuously for more than [2] minutes in a [20] minute time period or approximately 10% duty cycle. Attempting to circumvent or exceed this rating will shorten the life expectancy of the foundation and may void the warranty.

OPERATING INFORMATION

- After foundation assembly is complete, operate the remote control or App to ensure the bed is functioning properly.
- Keep moving parts free of obstruction during bed operation. This includes sheets, clothing, tubing, wiring, and electrical power cords.
- Distribute body weight evenly over bed surface. Do not place entire weight on head or foot sections of the bed, even while repositioning, entering, or exiting the bed.

HOSPITAL USE DISCLAIMER

- This bed base is NOT designed for hospital use and does NOT meet hospital standards.

RADIO FREQUENCY: 2.4 GHz

FCC COMPLIANCE:

This device complies with Part 15 of the FCC Rules. Operation is subject to the following two conditions: (1) This device may not cause harmful interference, and (2) this device must accept any interference received, including interference that may cause undesired operation.

To comply with the FCC RF exposure requirements, no change to the antenna or the device is permitted. Any change to the antenna or the device could result in the device exceeding the RF exposure requirement and void user's right to operate the device.

SPECIFICATIONS



Power Input
DC 29.0V \approx 1.8A



Head Motor Thrust
6000N



Foot Motor Thrust
4000N



Operating Noise
<43dB



2 Person Assembly



Max. Load
750 lbs / 340kg

STANDARD PARTS LIST

Before disposing of the packaging materials, make sure all components are installed. Components are typically located in boxes under the bed base or attached to the frame.

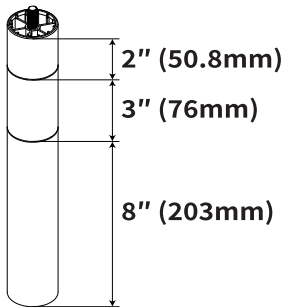

Bed Leg

A x 6

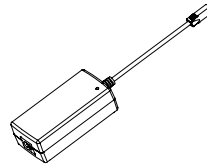

Power Supply
(29V 1.8A)

B x 1

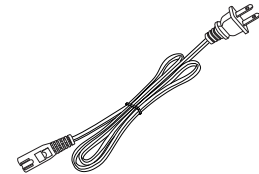

AC Power Cord

C x 1

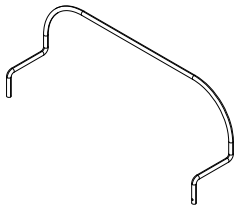

Mattress Retainer Bar

D x 1



Remote Control

E x 1



AAA Batteries

OPTIONAL ACCESSORIES

NOTE!

You will need this strap if you have two Twin XL bases.

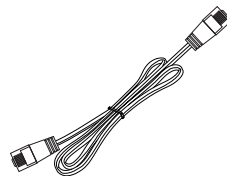

Sync Cord

F x 1

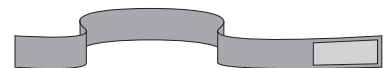

Bed Leg Strap

G x 1

1 Attaching the Bed Legs

Hand tighten the six legs [A] by threading them clockwise into the pre-threaded holes on the bed base.

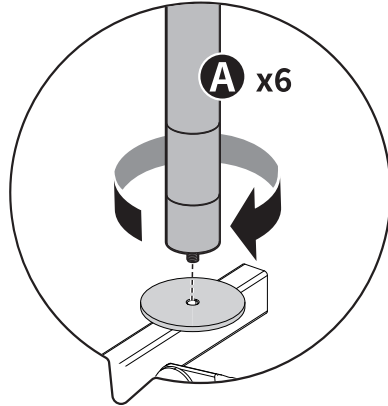

NOTE: Each leg is comprised of 3 sections to provide multiple height configurations. Attach the legs according to your desired height before attaching to the base.

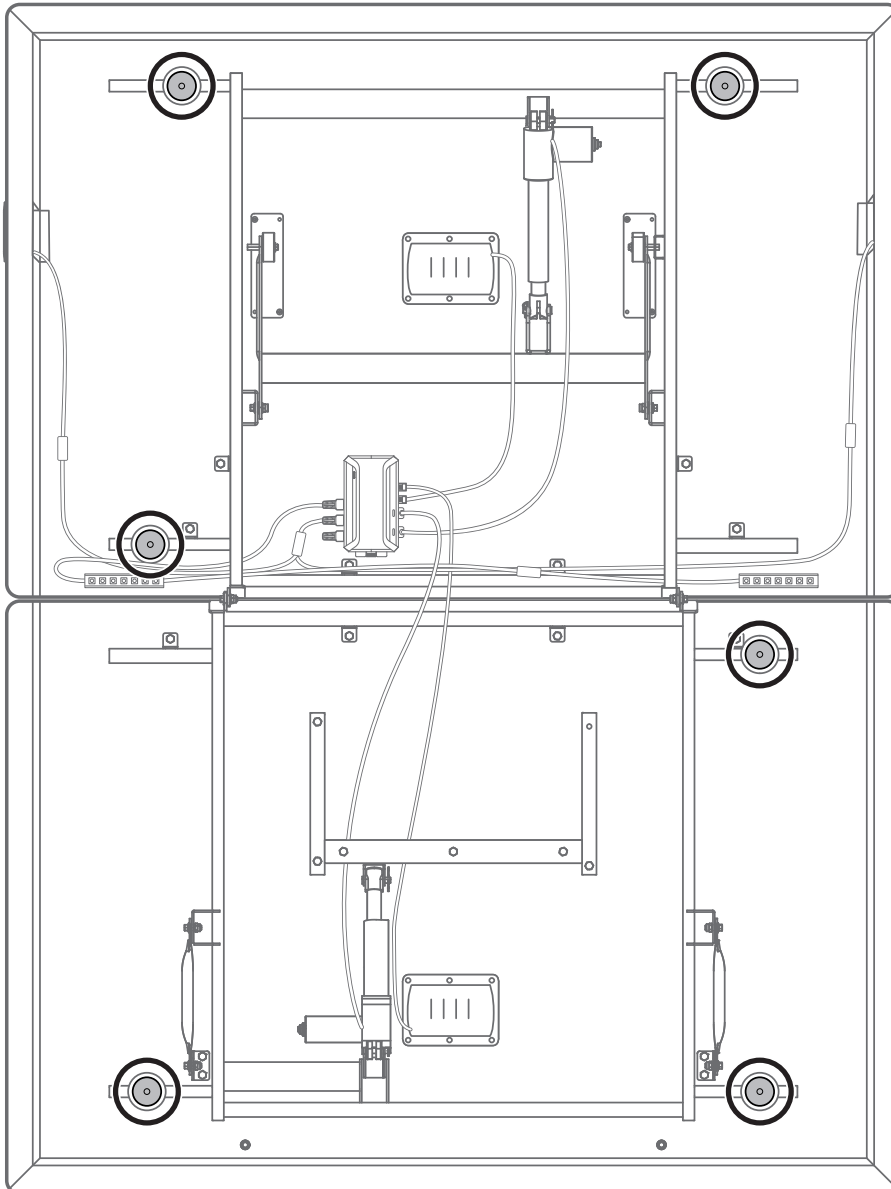

2 Setting up the Electronics

Plug the AC power cord [C] into the power supply [B], then connect it to the wire harness located underneath the bed.

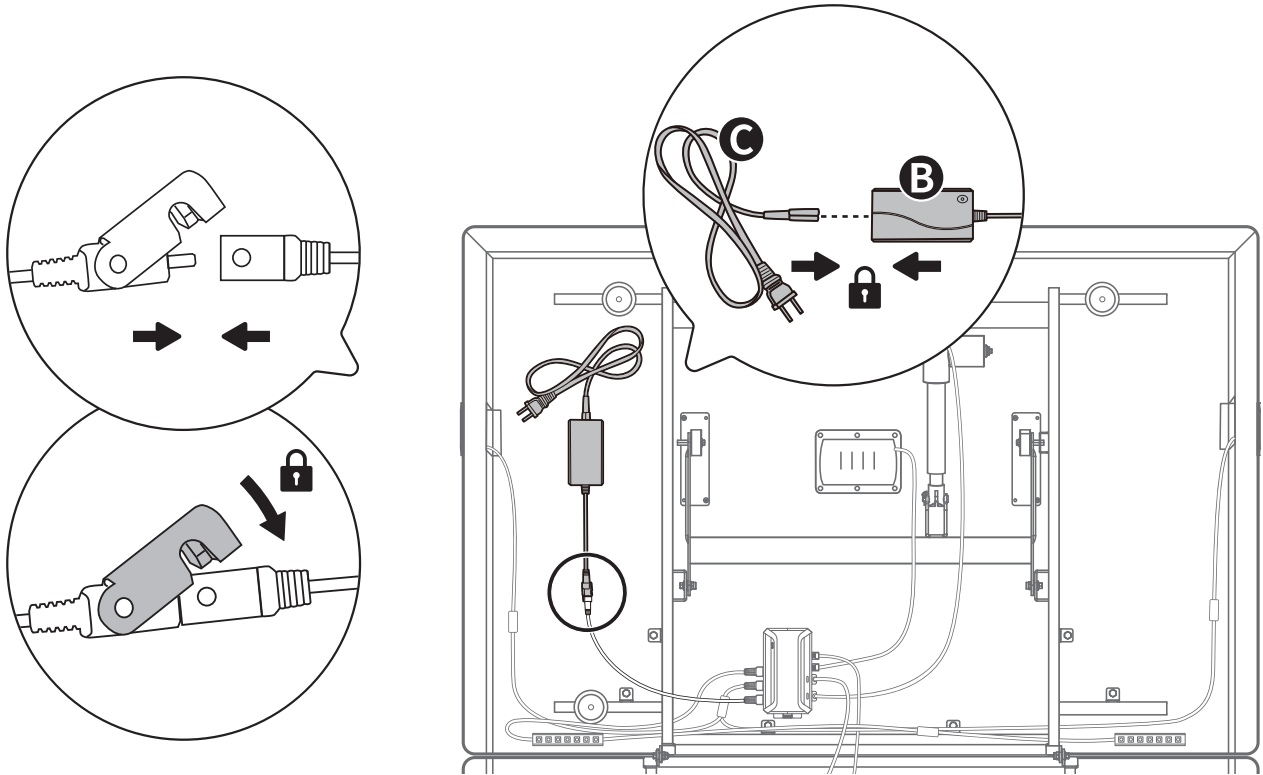

3 Inserting the Mattress Retainer Bar

Flip the bed base over. Insert the mattress retainer bar [D] into the holes at the footboard, then plug in the power cord.



HEAVY! You may need assistance with this step.

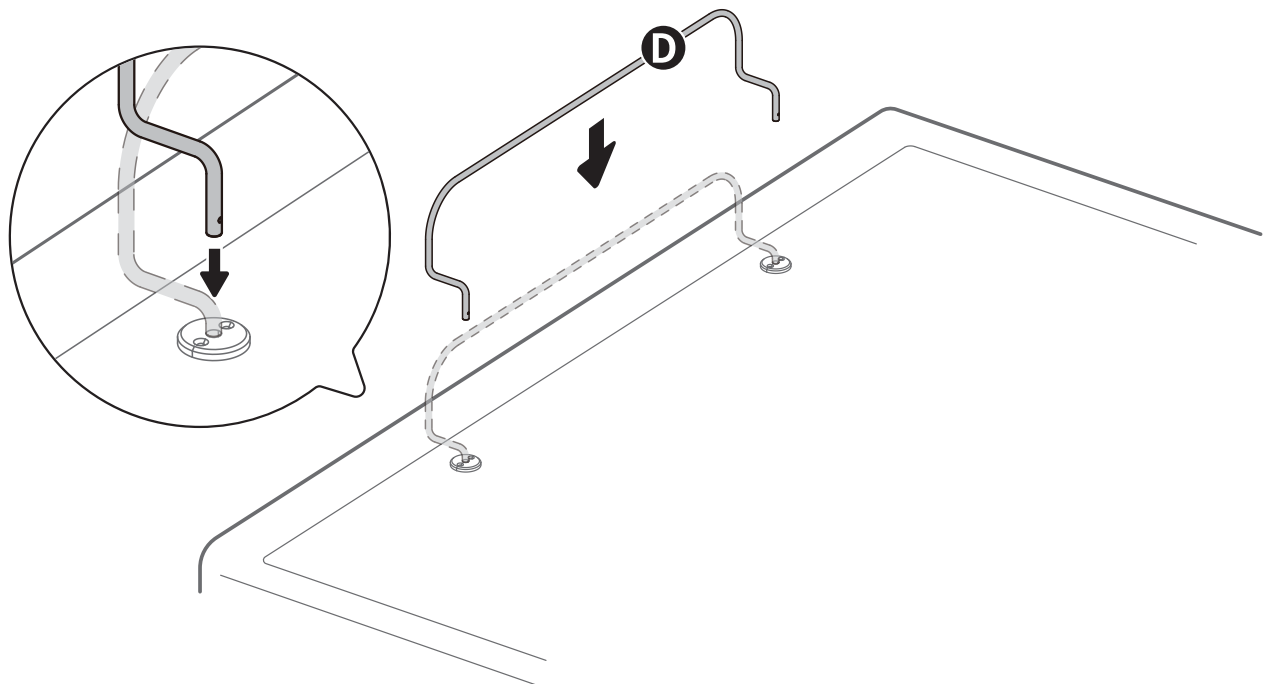

BED BASE DIAGRAM

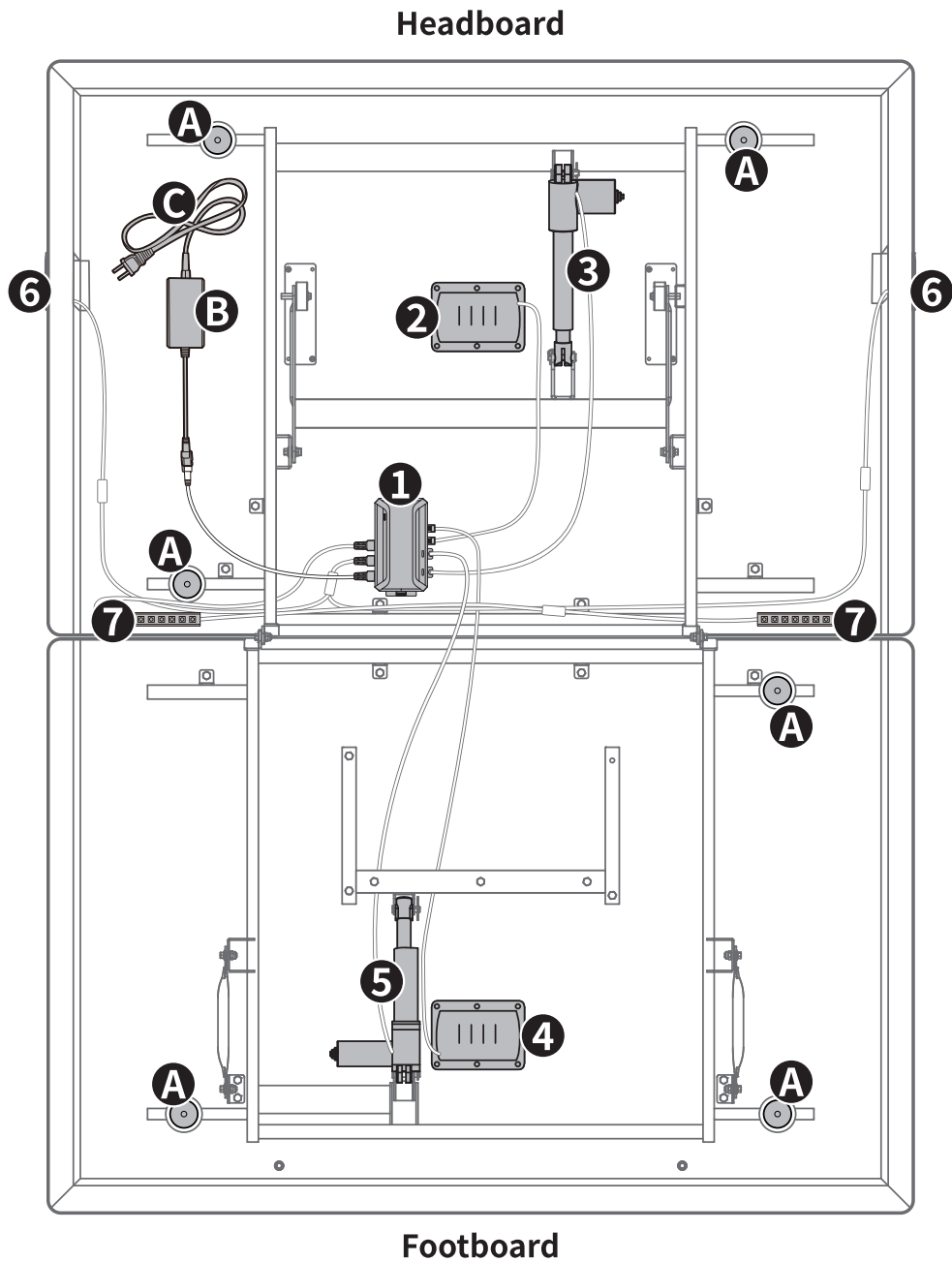



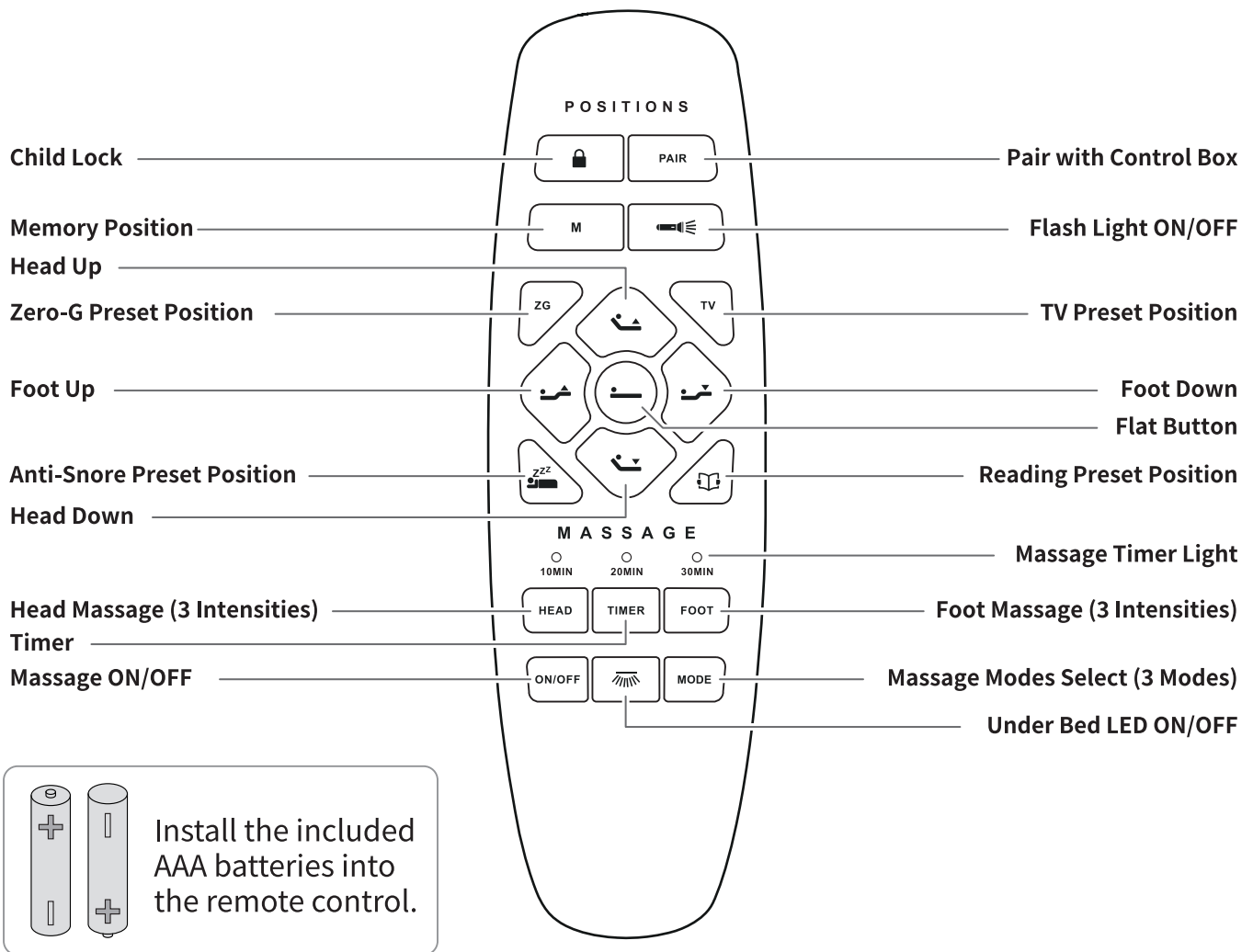

- | | | | |
|---|--------------------|---|---------------|
| 1 | Control Box | A | Leg |
| 2 | Head Massage Motor | B | Power Supply |
| 3 | Head Motor | C | AC Power Cord |
| 4 | Foot Massage Motor | | |
| 5 | Foot Motor | | |
| 6 | USB Ports | | |
| 7 | LED Lights | | |







REMOTE CONTROL







ADJUST

-  Press and hold to raise or lower the HEAD section.
-  Press and hold to raise or lower the FOOT section.
-  Press and hold the button to turn the flashlight on.
-  Press and hold the button for 5 seconds to lock or unlock the remote control.

ONE-TOUCH BUTTONS

-  Programmable preset position.
-  ZG preset position.
-  TV preset position.
-  FLAT preset position.
-  Under bed LED light on/off.
-  Anti-snore preset position.
-  READING preset position.

MESSAGE FEATURE

-  Press to turn on the head massage.
-  The light indicates the 10, 20 or 30 minute timer settings.
-  Press to turn on the foot massage.
-  Message ON/OFF.
-  Press to choose between 3 massage settings.

PAIRING REMOTE

The remote comes paired to the bed. If the remote becomes unpaired or is unresponsive, perform the following to pair the remote:

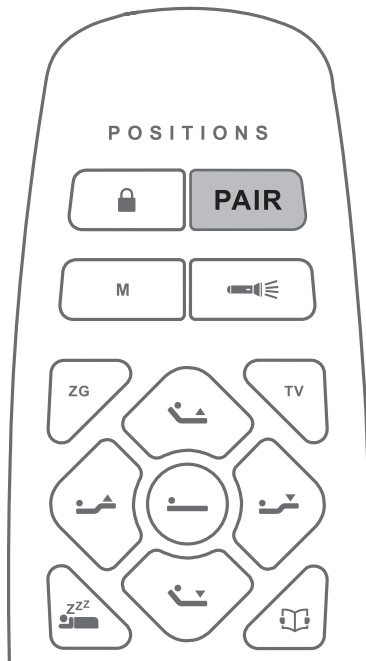

STEP 1:

Make sure the batteries are working. Replace them when needed.

STEP 2:

Unplug the power cord and then reconnect it to the power source. Immediately press and hold the **PAIR** button for 5 seconds. The lights will flash then stop. Remote is now paired.

PROGRAMMABLE BED POSITION

The bed base has a programmable feature that allows you to save a custom position. Please read all the instructions below before setting your custom presets on the remote.

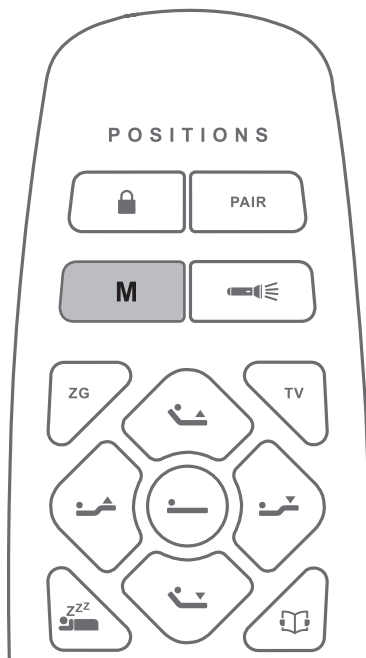

STEP 1:

Adjust the head and foot to your desired position.

STEP 2:

Press and hold memory button **M** for 10 seconds until the lights on the remote are flashing. Now the position is saved.

STEP 3:

To adjust the saved position, repeat Steps 1 and 2 and the new position will be saved.

PRESET BED POSITIONS

TV SETTING:

Head Angle	50°
Foot Angle	35°

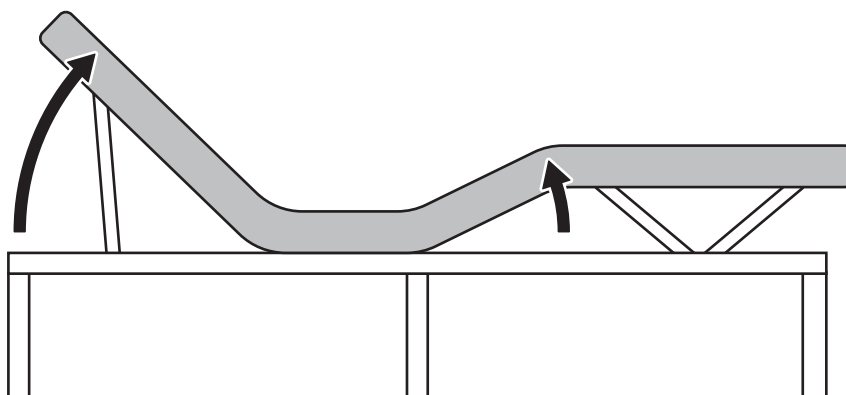

ANTI-SNORE SETTING:

Head Angle	10°
Foot Angle	0°

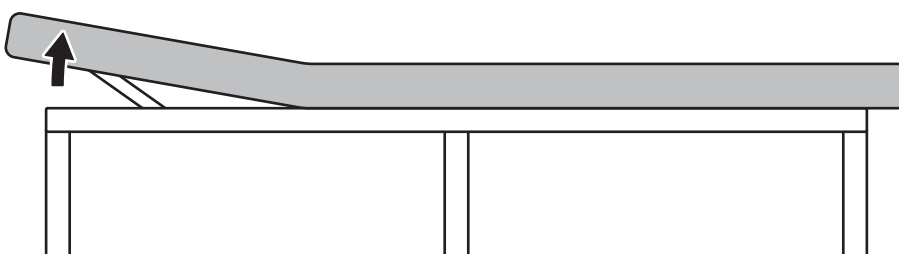

ZERO GRAVITY (ZG) SETTING:

Head Angle	18°
Foot Angle	40°

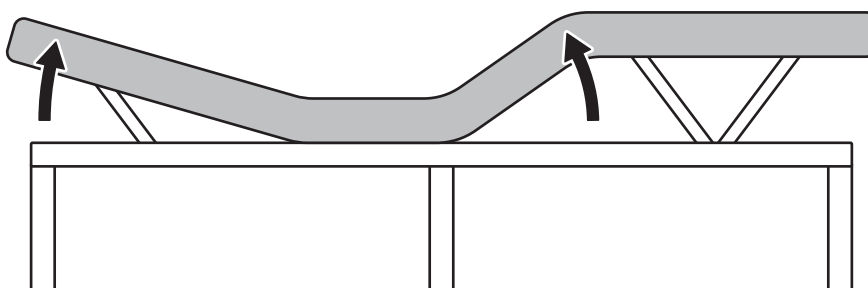

READING SETTING:

Head Angle	40°
Foot Angle	30°

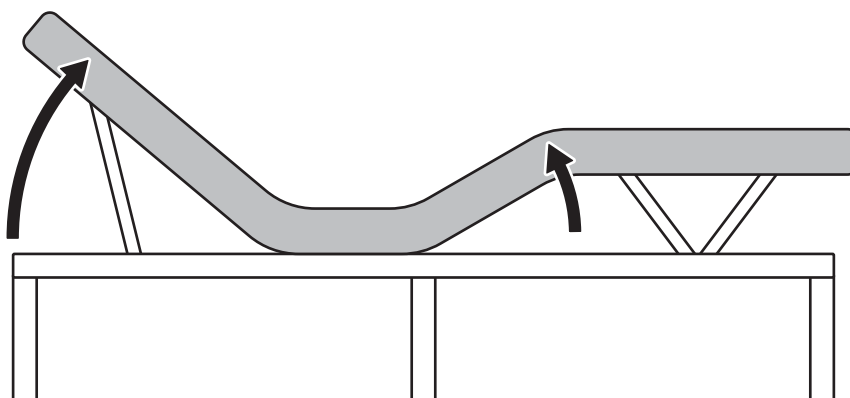

RESET PRESET POSITIONS

The remote comes with PRESET buttons for: zero gravity, TV, anti-snore and reading settings. A user may want to CUSTOMIZE their settings to their own preference. For example:

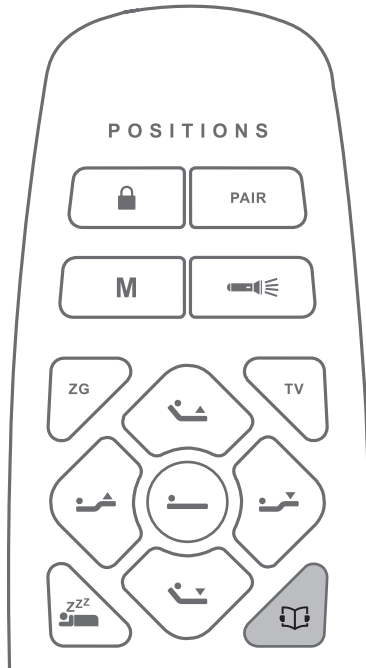

STEP 1:



Adjust the bed to your desired READING position.

STEP 2:

Press and hold  for 10 seconds. The lights on the remote will flash. The READING preset is now customized to your personal preference.

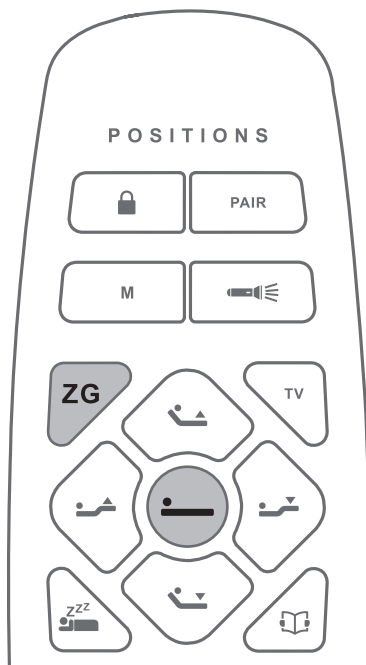
If you want to go back to the ORIGINAL FACTORY SETTINGS:



Press and hold  +  for 10 seconds. The lights on the remote will flash.

THE STANDARD BED CONTROL APP

1. Download

Download the App by searching in App store: iOS (App store), Android (Google play / Huawei App store)

iOS
App store

Google play

Huawei
APP store

2. Log in

After downloading the App, click on it and log in.

If you are a first-time user, you can sign up using your mobile phone or email.



3. Connect

Power on the control box. Once successfully logged in, click the icon  in the upper left corner of the connection page as follows.

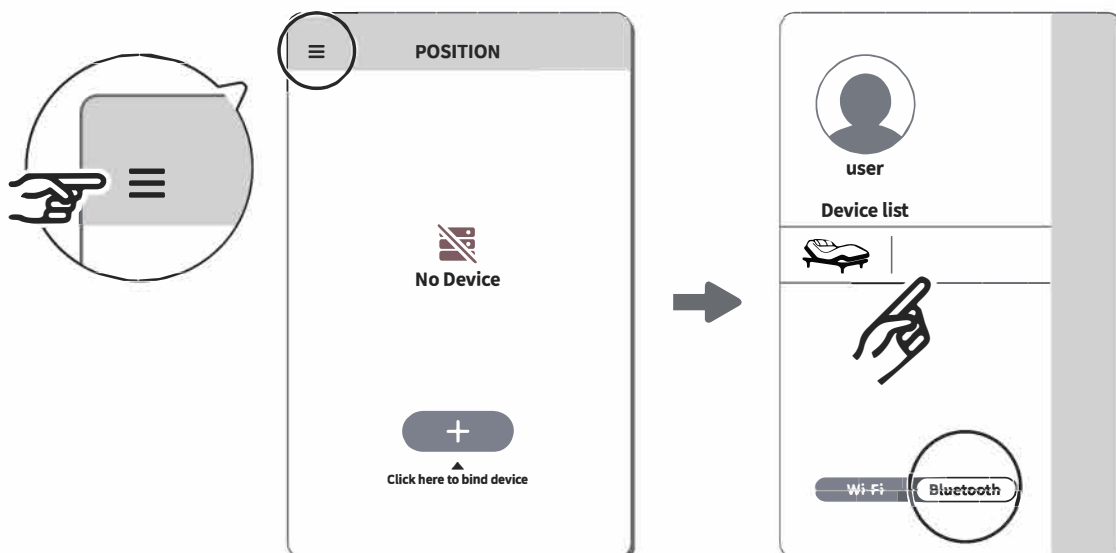

Additional Feature of iOS Version 12 or Above: Siri Voice Control

NOTE: The App for iOS offers the feature in the upper right corner. Click to access the shortcut options.

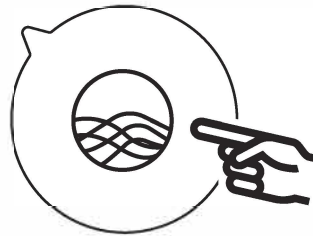
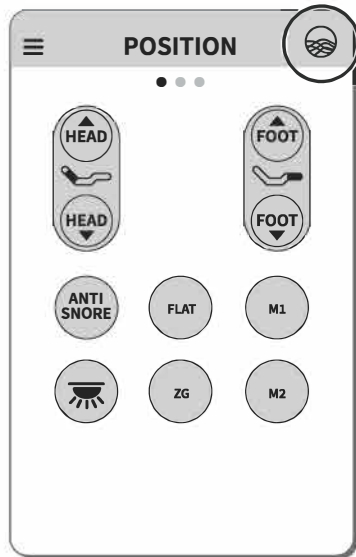

1. Click on the icon in the upper right corner to access the shortcut settings page.

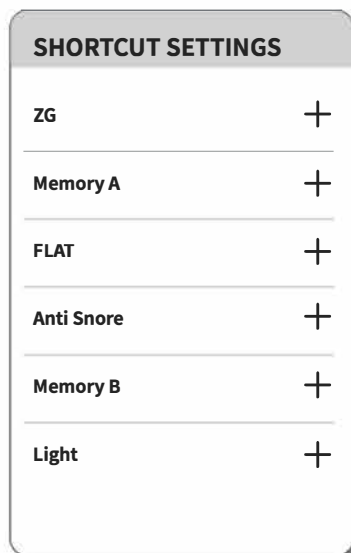

2. Click "+", then you can add a custom phrase and run this shortcut by Siri.

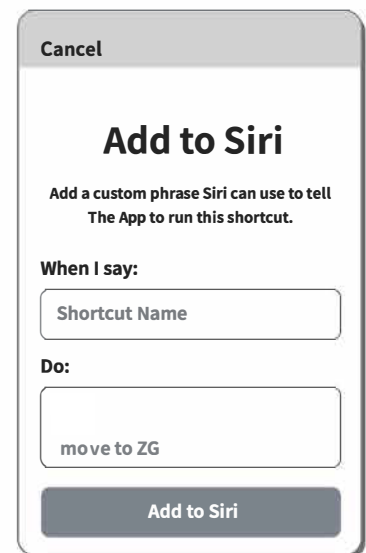

Your bed is now ready to be controlled using the App.



SYNCHRONIZING TWO TWIN XL BASES

⚠ WARNING The sync cord is for TWO TWIN XL bases only.

STEP 1:

Secure the two twin XL bases together using the bed leg strap [G]. Make sure that both bases (A & B) are connected to a power source and are in the flat position.

STEP 2:

Using the provided sync cord [F] to connect both control boxes (A & B).

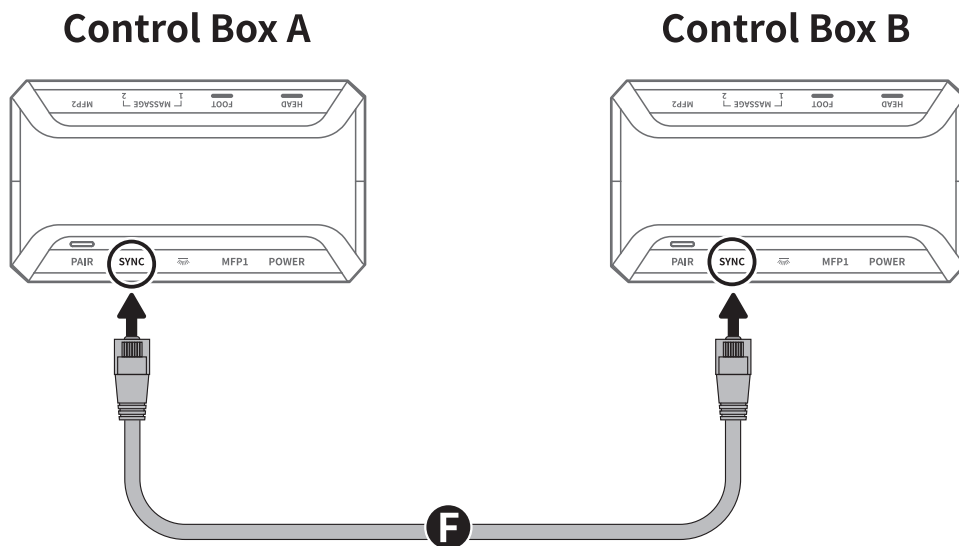

STEP 3:

The bases (A & B) can be simultaneously operated by the same remote.

NOTE:
⚠ Wrap the bed legs (front & back) together tightly using the bed leg strap [G]. Fasten the strap to prevent movement & maintain stability.

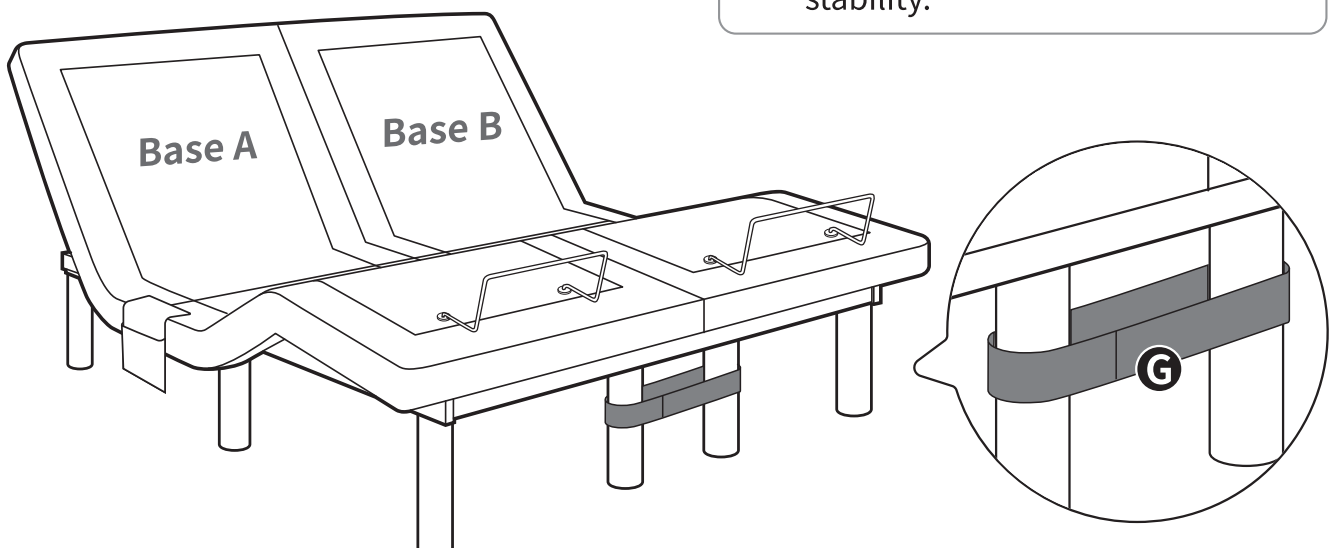

TROUBLESHOOTING

In the event that the bed base fails to operate, review these symptoms and possible solutions:

SYMPTOMS	SOLUTIONS
<p>Remote control illuminates and appears to be operable, but can't activate bed.</p>	<ol style="list-style-type: none">1. Verify that the power cord is plugged into a working, grounded electrical outlet. Test the outlet by plugging in another working appliance.2. Check the child lock feature. To ACTIVATE or to DEACTIVATE the Child Lock Button on the remote, press and hold for 5 seconds.
<p>No features of the bed base can activate.</p>	<ol style="list-style-type: none">1. Program the remote control. See the Programmable Bed Position and Pairing Remote section of this manual for instructions.2. Unplug the power cord, wait 30 seconds and plug back in to reset electronic components.3. The surge protection device or the electrical outlet may be defective.4. Test the outlet by plugging in another working appliance.5. Verify that the connector on the wired remote control is securely attached to the control box.
<p>Remote control does not illuminate.</p>	<p>Replace the batteries in the remote control.</p>

<p>Remote control is unresponsive.</p>	<ol style="list-style-type: none"> 1. PAIR the remote. Unplug the base from the electrical outlet, HOLD the PAIR button on the remote, then plug back in. CONTINUE TO HOLD THE PAIR BUTTON. The lights will flash under the base. When the lights stop flashing, release the PAIR button. The remote is now paired. 2. Check the Child Lock. With this feature, if it is "ON" the remote will appear "DEAD" even after changing batteries. TO ACTIVATE or to DEACTIVATE the Child Lock Button on the remote, press and hold for 5 seconds. 3. Restore Factory Settings. On the remote control, PRESS and HOLD the ZG and FLAT buttons for 10 seconds until the backlight flashes. All customized settings on the remote control and the control box are now cleared or returned to factory default settings.
<p>Head or foot section can elevate, but can't return to the flat position.</p>	<ol style="list-style-type: none"> 1. Bed mechanism may be obstructed. Elevate bed and check for obstruction. Remove obstruction. 2. Head section may be too close to the wall. 3. Headboard may be too close to the edge of the mattress. Verify that there is enough distance between the headboard brackets and mattress. Adjust if required.
<p>Remote control illuminates but base does not function.</p>	<p>RESET the REMOTE back to factory settings.</p> <ol style="list-style-type: none"> 1. On the remote control, PRESS and HOLD the ZG and FLAT buttons for 10 seconds until the backlight flashes. 2. All customized settings on the remote control and the control box are now cleared or returned to the factory default settings.

<p>Head & Foot lift function has minor interference during operation.</p>	<ol style="list-style-type: none"> 1. Check batteries in remote control, replace with two new AAA batteries if necessary. 2. Press the lift buttons squarely and accurately. 3. Remote control may be experiencing common Radio Frequency Interference from other radio transmitting devices. Wait several seconds, and then try pressing appropriate button again. See FCC Compliance Statement on Page 03 of this manual.
<p>A clicking noise is heard under the bed when raising or lowering.</p>	<p>This is normal. The lift motor relays “click” when they are engaged. No action is required.</p>