

LED Lamp Wall Sconce

AT6506-GD

INSTALLATION SHEET

START FROM HERE

- Make sure power is completely off at the fuse box.
- Have your fixture installed by a qualified licensed electrician
- Prepare everything in a clear area.
- Wear gloves at all times during this installation.
- Read instructions carefully before you start assembly.
- Keep this instruction sheet for future reference.

Technical Support: 1-855-855-8926

Please Note:

- This Kuzco LED fixture comes with pre-wired LED module(s)
- Unless instructed to do so, please do not touch any part of the LED module(s) as any unnecessary contact with the module could cause permanent damage.
- For dimming, an ELV (Electronic Low Voltage) type of dimmer is required.
- Dry Location Only
- 120V input

- 1.** Remove the fixture from its original packaging. Remove the mounting plate **(1c)** from within the canopy backplate **(2a)** by loosening the four set screws **(2d)** and two screws **(2b)**. Secure the mounting plate **(1c)** to the junction box **(1a)** with screws **(1d)** provided in the hardware package.
- 2.** Attach the canopy backplate **(2a)** to the mounting plate **(1c)**, which is attached to the electrical junction box **(1a)** on the wall. First attach all wiring with the provided marrettes **(1b)** (white to white "N", black to black "L", ground to ground "G"). Now direct the canopy backplate **(2a)** onto the mounting plate **(1c)** be sure to line up the mounting threaded holes with the screws **(2b)**. Next, place the canopy **(2c)** onto the canopy backplate **(2a)** and secure with all four set screws **(2d)** turning clockwise.
- 3.** You have now completed the installation of your fixture, enjoy.

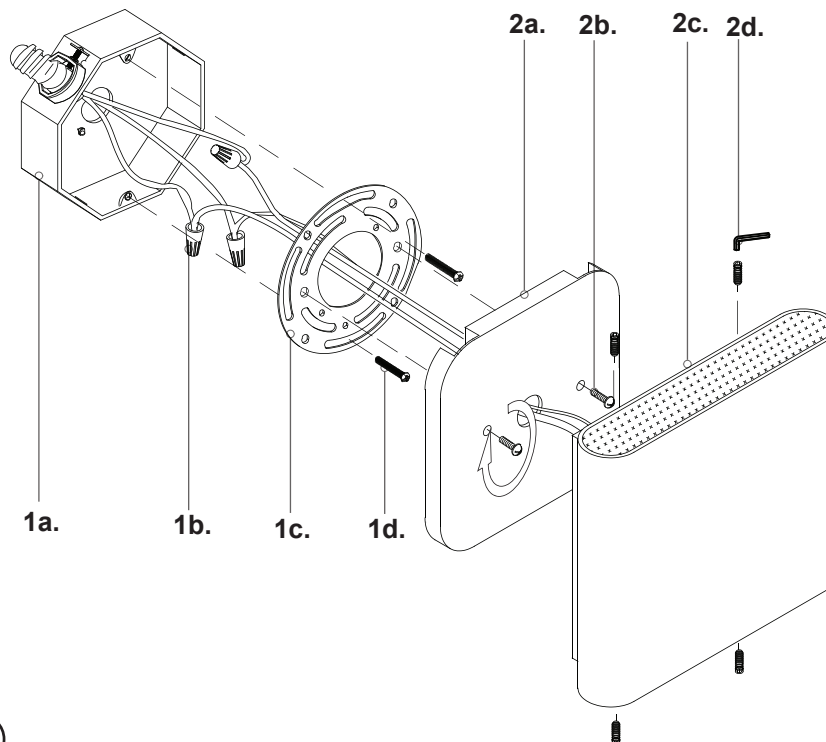

KUZCO

19054 28th Avenue Surrey, BC Canada V3Z 6M3
T: 604 538 7162 TF: 1-855 85 KUZCO F: 604 538 7196
W: kuzcolighting.com
20181127