

Gaming Chair NEMSG-TPG-CFT



Missing parts, damages, and any problems in the installation process, please contact us by text or email. Please choose SMS or email as your first choice for communicating with us.

 +1(503)928-7812

 hellovitesse@gmail.com

Warning

Please read the instructions carefully before installing the product, and do not use the product before the installation is complete. If the product is damaged or defective, please contact customer service in time.

* Indoor use only.

* Please keep the instructions in case of further use.

* To avoid personal injury, don't use the damaged product, and dispose it properly.

* To avoid personal injury, do not stand on the product.

* To avoid personal injury, place the product on the flat ground.

* To avoid product damage and personal injury, please check the product's load capacity and do not support user's whole body on the chair arms.

* To avoid product damage and personal injury, assemble the product properly.

* The features and specifications of the product are subjects to changes without prior notice.

* Please move the product gently to avoid collision.

* Please ensure the centre of gravity is on the hydraulic during sitting.

* Please watch your fingers when you adjusting the backrest angle.

* Please toggle the handle gently which under your seat when adjusting the chair height.

* Please do not use strong acid or strong alkaline cleaners to clean the chair.

* Considering the parts loosing during use, please tighten the screws **every three months**.

Parts list

(1)Caster X5



(2)Base

Packed separately

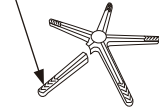

(3)Gas Lift



(4)Mechanism

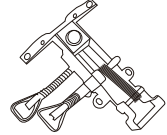

(5)Seat



(6)Back



(7)Left&right arm

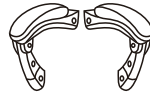

(8)Footrest

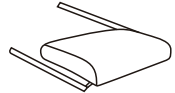

(9)Headrest cushion

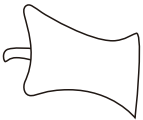

(10)Lumbar cushion

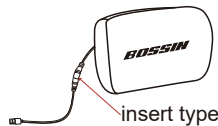

(11)Back iron



(12)Plastic cover



(A)X4 (M6*20mm)



(B)X4 (M8*20mm)



(C)X4(M8*30mm)



(D)X4(M6*25mm)



(E)X4 Screw cover



(F)X8 metal gasket



(G)X2 Rubber ring



(H)X1(M6*75*55MM)



(I)X4 Metal gasket
(Φ=30mm)



Installation steps

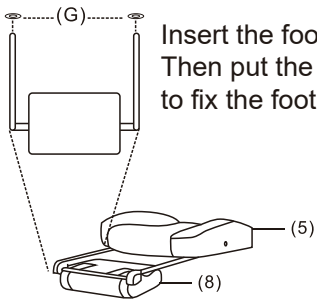
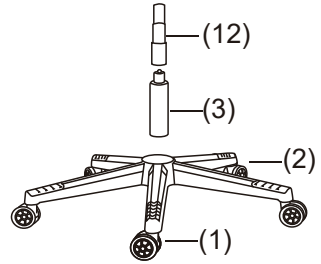
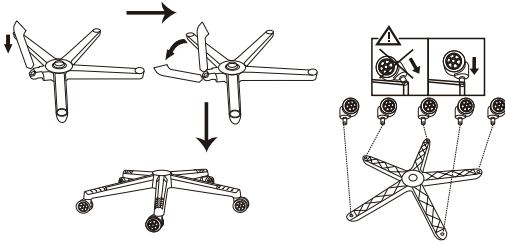

Insert the footrest under the seat. Then put the rubber ring(G) on it to fix the footrest.

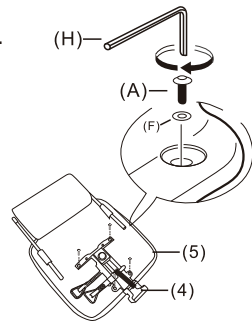

For easier assemble, please put in all the screws first, but not tighten all.

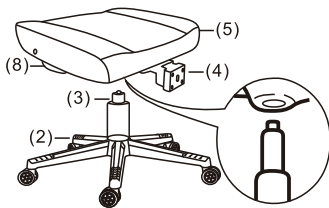

⑤

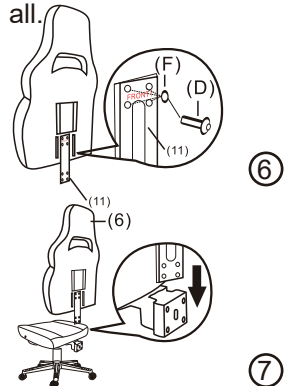

⑥

⑦

Please note: the side of back iron which labeled FRONT is facing outward, not labeled is facing inward

Installation steps

Please half-tighten all the screws into the holes in advance.
Make sure the back is vertical to seat before you fully tighten the screws.

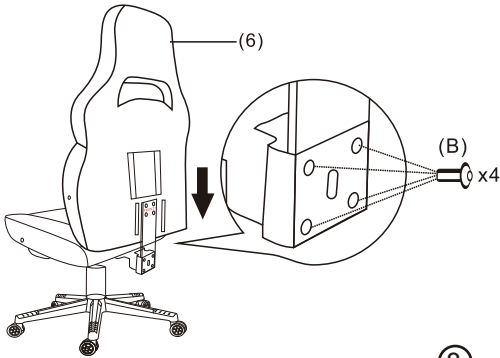

8

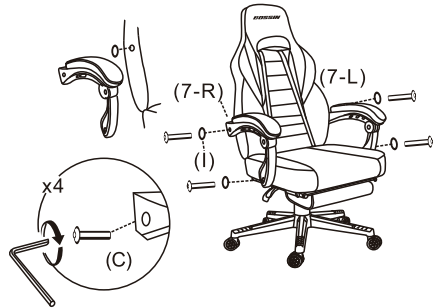

9

After all the screws are set, fully tighten them

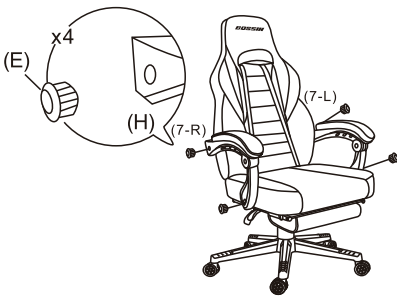

10

Please insert two
connector, enjoy
your massage time

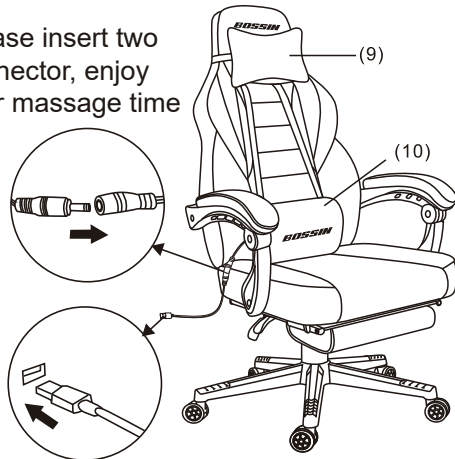

11

Function

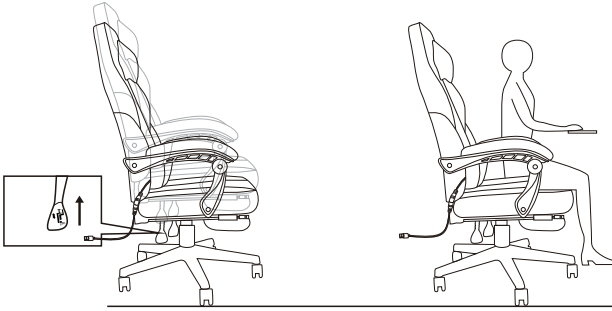

Lifting function

Lift up: move your body from the chair and then lift the height control handle.

Lift down: Seat down on the chair and push the height control handle.

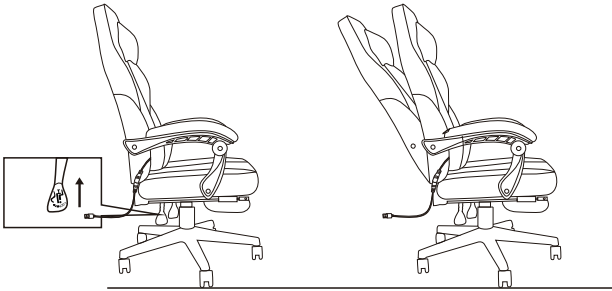

Tilt function

Use the other control handle, you can lock the angle or adjust it to what angle you want.

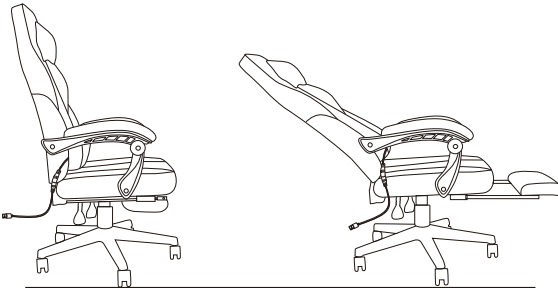

WARNING!

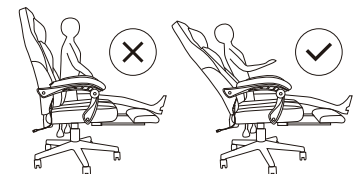

Do not unfold footrest and make chair back vertical simultaneously, the chair will tilt due to the shift in center of gravity. Please lie down the back when using the footrest.

1.

Q: The chair doesn't stay at the height I want, and sunk when I sit on it.What should I do?

A: This problem can be solved by replacing the gas lift.Please find our YouTube channel(vitessegaming), we uploaded the video of gas lift moving process (named:re move the gas lift). If you can't solve the problem even with the help of the video, please contact us and we will send you a new replacement part.

2.

Q: I received a screw that couldn't match with the hole or I received an incomplete screw, what should I do?

A: If the screw didn't match or couldn't tight with hole, please check whether the screw has thread or the hole has thread. If not, please contact us, we will send you replacements.

3.

Q:What to do if the massage lumbar support is defective?

A: First, please reconnect the message's wire and check if the wire is broken. If it still not work, please contact us we will send a replacement massage lumbar support.



+1(503)928-7812



hellovitesse@gmail.com



Instagram: vitessegaming



YouTube : vitessegaming

Please feel free to **send us the text or email**. We will reply to you within 24 hours. Also please feel free to contact us if you have received the defective items.

Follow our YouTube Channel then you will be able to find our **assembling video** as a pinned video.