

ASSEMBLY INSTRUCTION

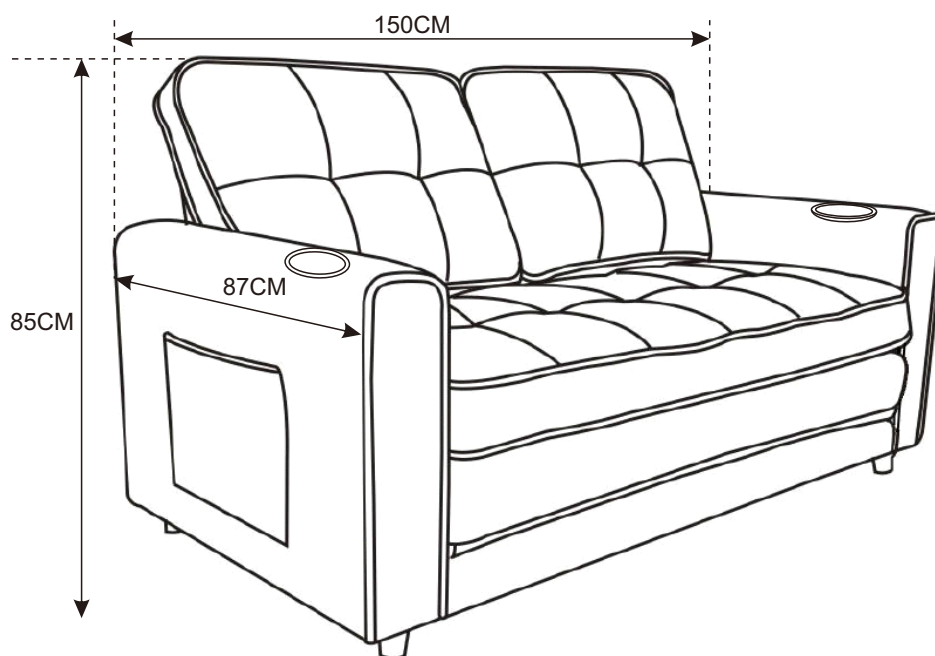

Return & Warranty policy:

-We strive to offer the highest quality products, and we also try our best to satisfy each and every customer that orders from us with replacement parts/or service as needed.

-1. If the item is damaged or defective, please take photos as evidence for replacements and refunds.





-Please do not return to store, contact the seller if you have any troubles with this product.

-2. As the cushions are all vacuum compressed, there will be some wrinkles.

Please give your cushions up to 72 hours to reach its original size and the wrinkles will basically disappear.

-3. Please do not open the compressed packages until your sofa frame is completely assembled.

ASSEMBLY INSTRUCTION

HARDWARE LIST			
NO	DESCRIPTION	SKETCH	QTY
1	PLASTIC GASKET		4 PCS
2	SCREWS M 8*60MM		4 PCS
3	GASKET		4 PCS
4	ALLEN KEY		1 PC









PARTS LIST			
NO	DESCRIPTION	SKETCH	QTY
A	LEG		4PCS
B	BACK CUSHION		2PCS
C	SEAT FRAME		1PC
D	ARM		2PCS
E	SEAT		1PC
F	BACK REST		1PC
G	CUP HOLDER		2PCS

DIAGRAM1

Open the carton, and take out
2pcs back cushion and 1pc seat

B		2PCS
E		1PC

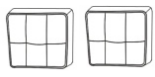
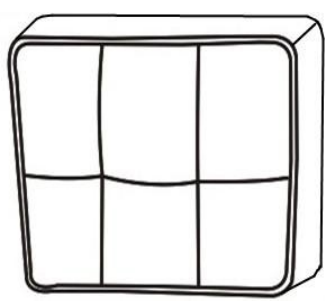
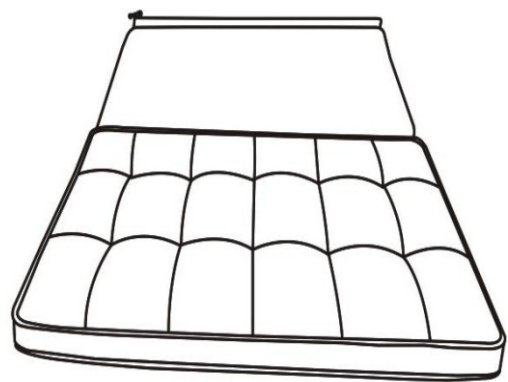
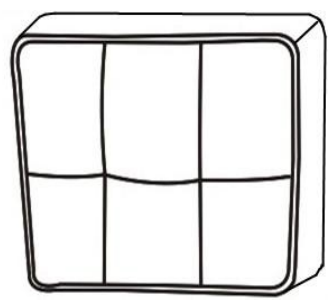
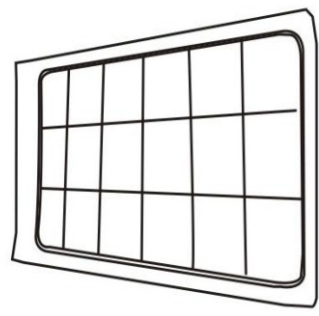
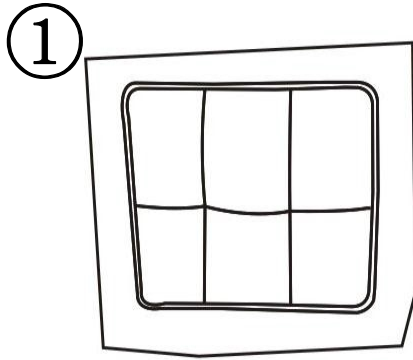
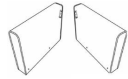





DIAGRAM2

Take out 2pcs arm, 1pc seat frame,
2pcs cup holder, 4pcs screws
M8X60MM, 4pcs gasket, and 1pc
allen key, connect arm and
seat frame with screws.

D		2PCS
C		1PC
2		4PCS
3		4PCS
4		1PC

②

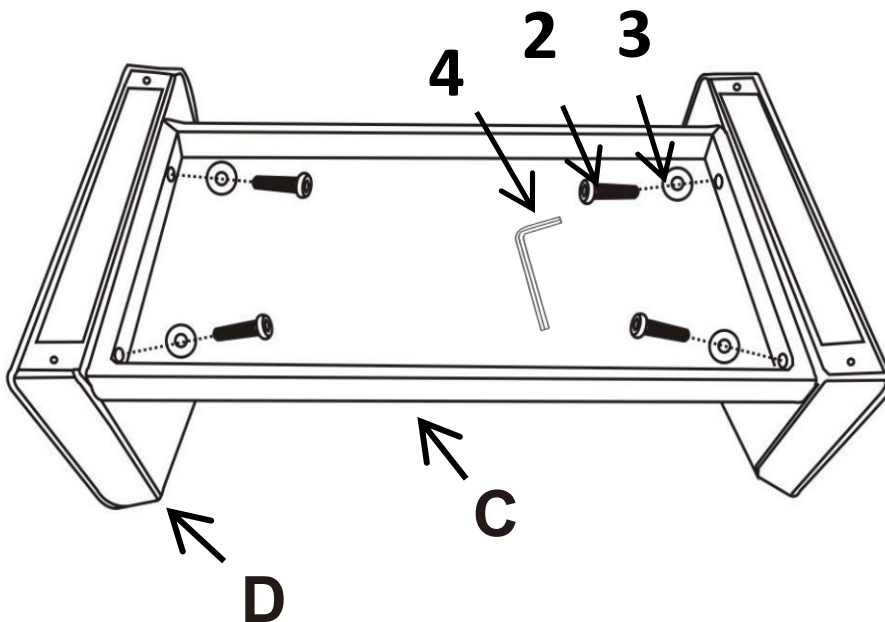
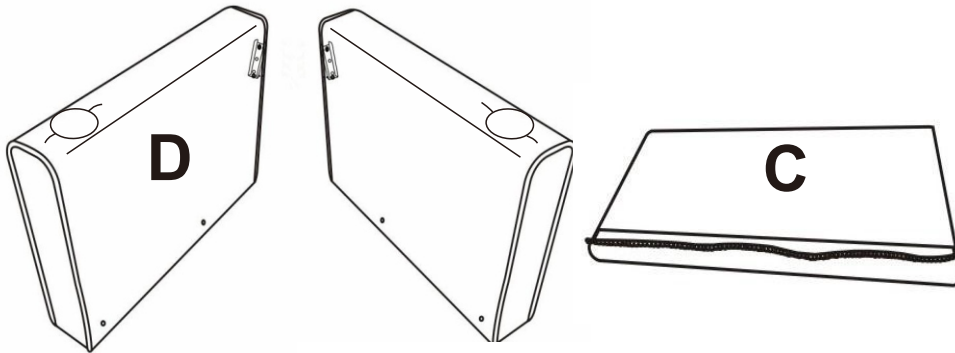



DIAGRAM3

Install the leg(A) of the sofa and insert a plastic gasket(1) in the middle

A		4PCS
1		4PCS

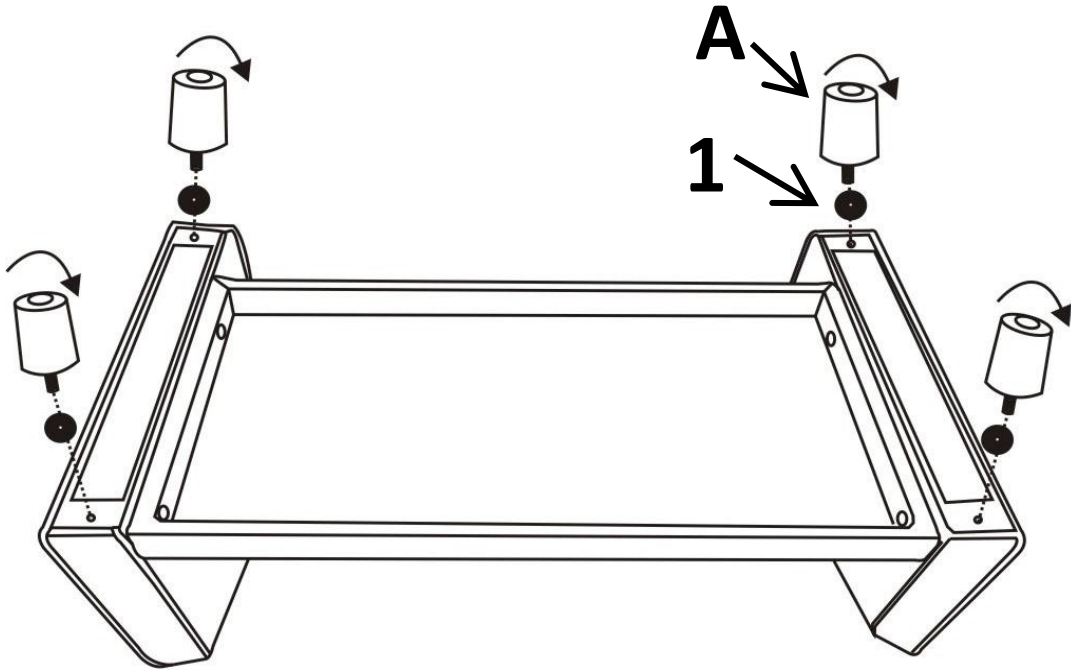



DIAGRAM4

Connect the Arm (C) and the Backrest (F)

F		1PC
---	---	-----

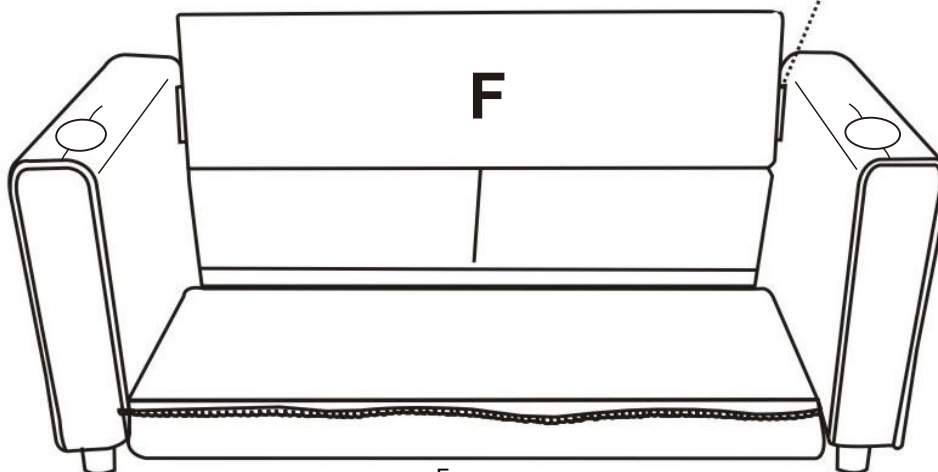
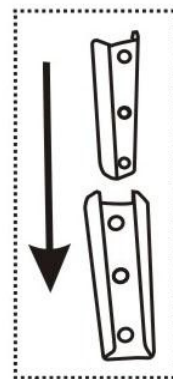
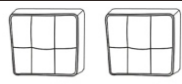



DIAGRAM5

Use the zipper to connect the seat (E) and seat frame. Put in the back cushion.

B		2PCS
E		1PC

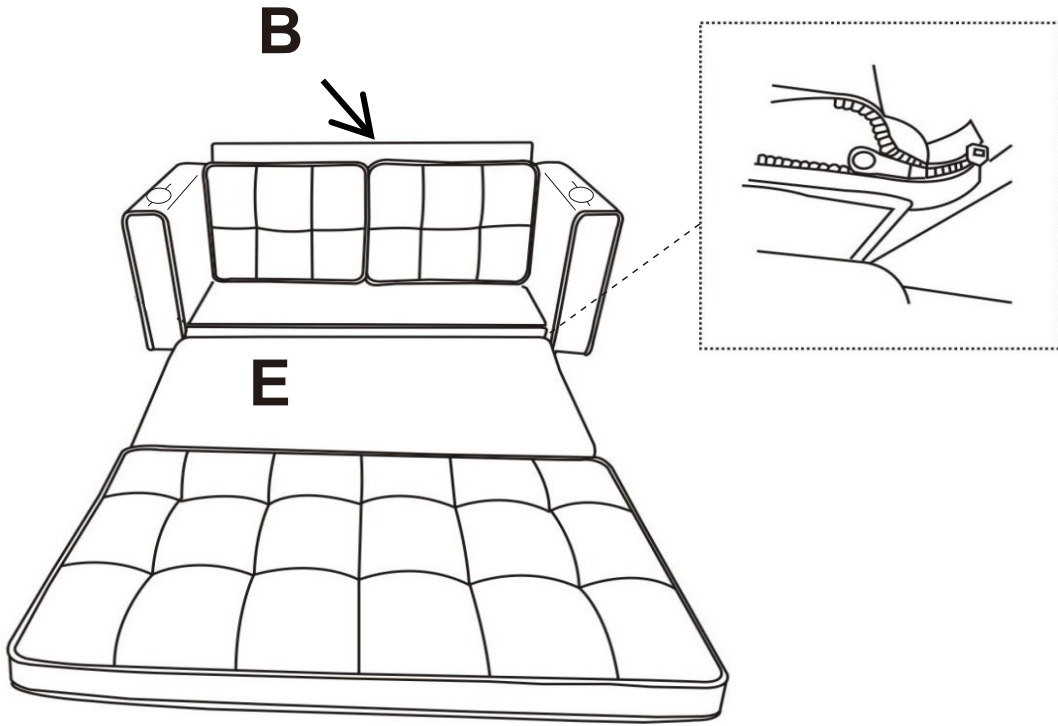

DIAGRAM6

Install the cup holder.

G		2PCS
---	---	------

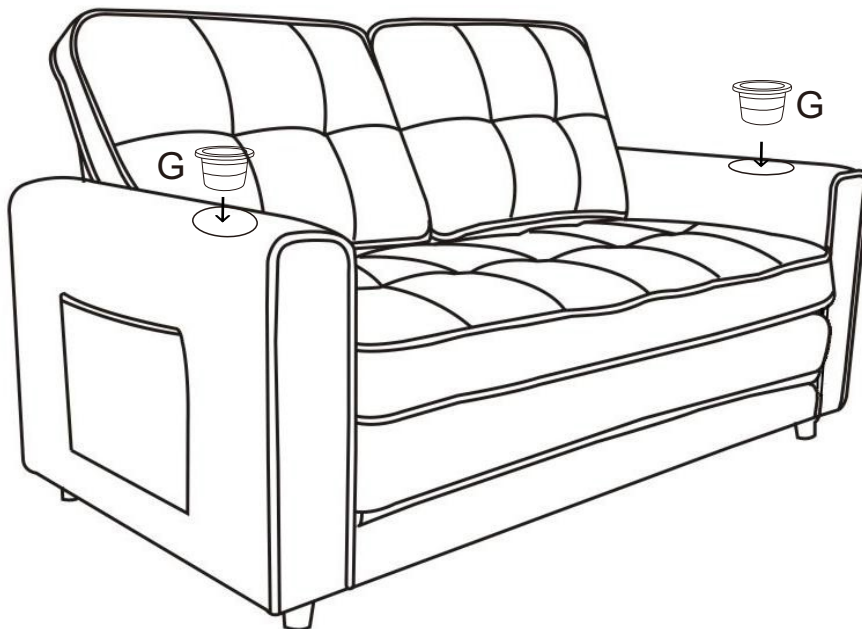

DIAGRAM7

Folding cushion.

