

A 1pcs

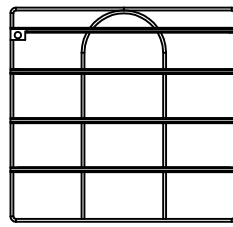

B 1pcs

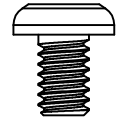

① 4pcs

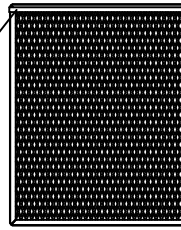

C 1pcs

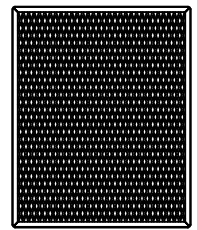

D 3pcs

There's a round tube here

1

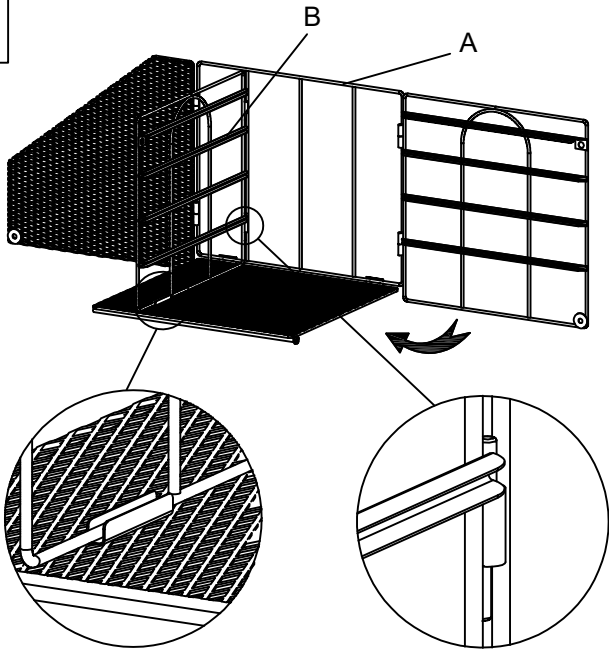

The mesh frame is inserted into the fixed slot

The shaft is inserted into the hinge

2

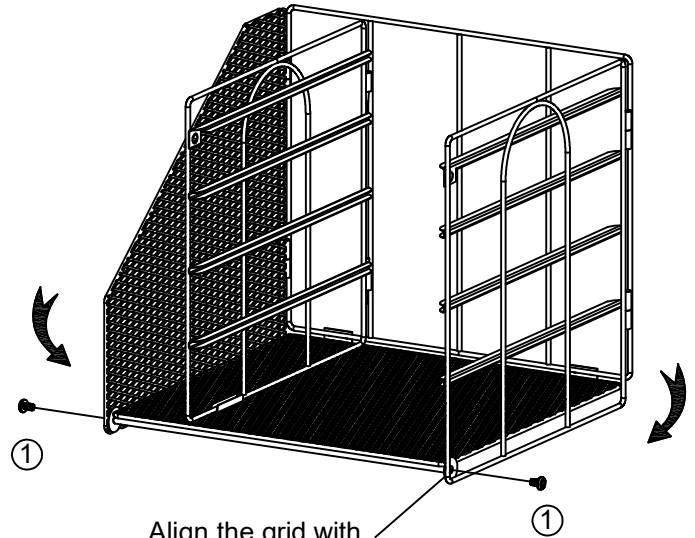

Align the grid with the mounting holes

3

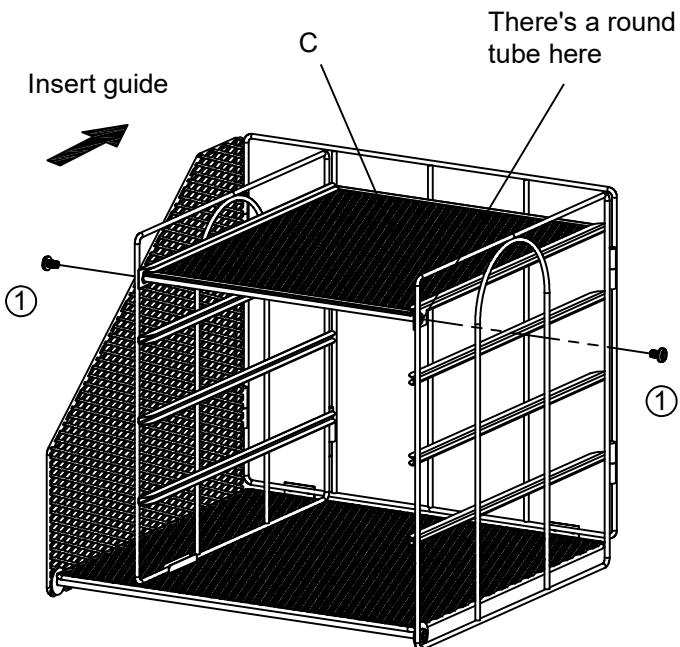

4

Finished

