

# Installation Instruction

D23.6"H7.1" LED

1

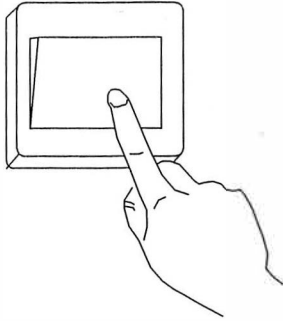

Turn off the power.

2

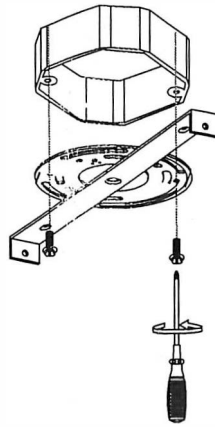

Install mounting bracket

3

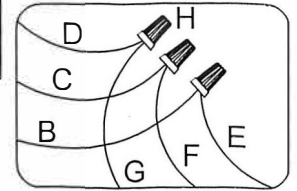

Wire connection

- B.Black wire (L) from junction box
- C.White wire (N) from junction box
- D.Green wire/bare copper (G) from junction box
- E.Black wire (L) from fixture
- F.Black wire (N) from fixture
- G.Green wire/bare copper from fixture
- H. wire connector x3

Connect wires

4

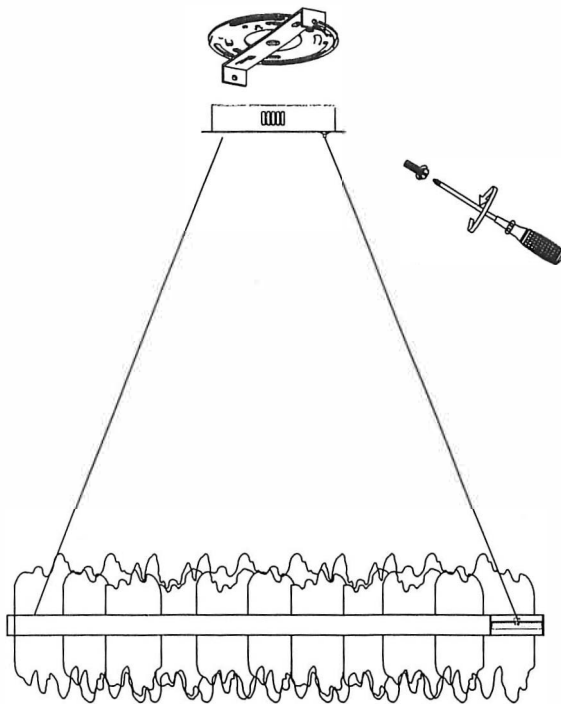

Fixed the canopy on the crossbar with ball nuts from the side hole of canopy

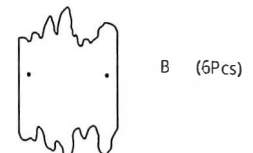
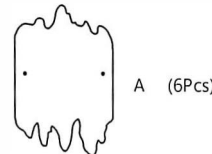
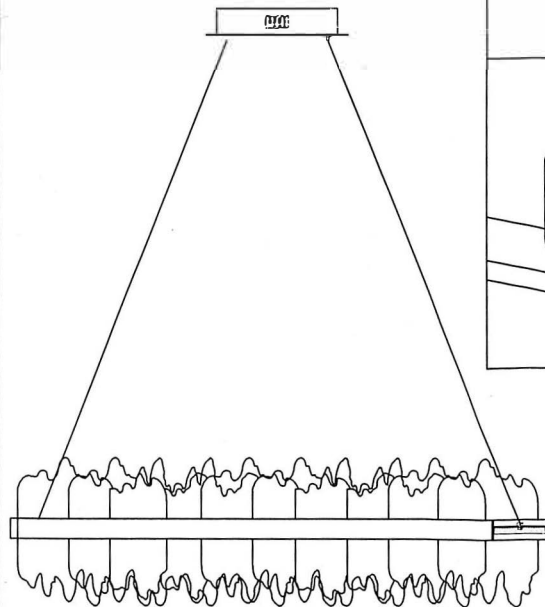

## Warning:

- 1.Please wear gloves during the installation.
- 2.Do not install on ceiling which is damp or with wet limewater.
- 3.Cut off the electricity before installation in case of being shocked.
- 4.Make sure the connected bolt is tightly locked



before getting through the electricity.

- 5.Do not cut off the electricity before washing or repairing, and use the scour without causticity.
- 6.Please cut off the electricity and wait until the bulb gets cooling before replacing the bulb in case of being burned.