

INSTALLATION & ASSEMBLY

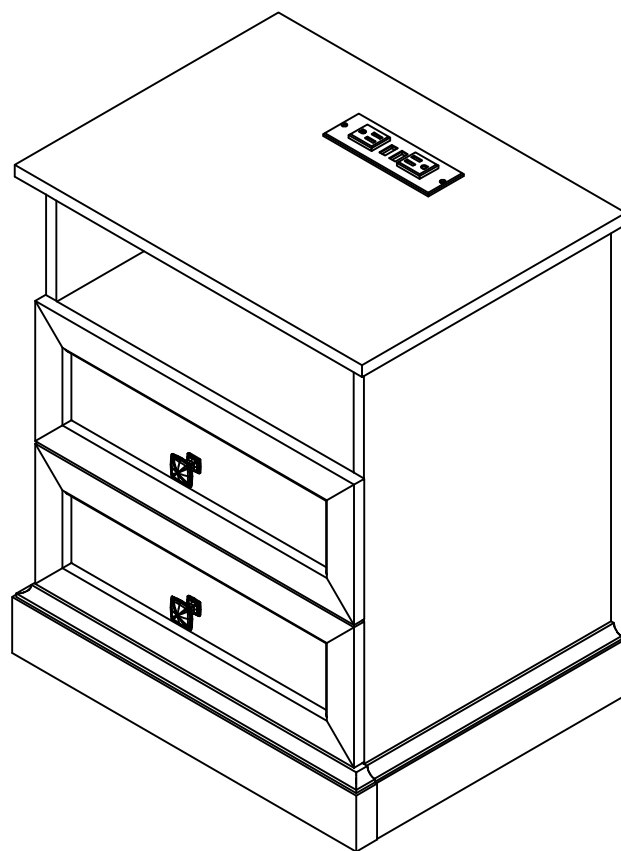

As this item contains many parts, please read the installation instruction carefully before installation . Please use tools properly and carefully. If you have any questions about the product and installation, please contact us.

Our professional after-sales team will serve you online all day.

Before You Start

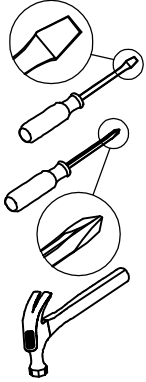

- ✓ Read through each step carefully and follow the proper order
- ✓ Separate and count all your parts and hardware
- ✓ Give yourself enough room for the assembly process
- ✓ Have the following tools: Flat Head Screwdriver, #2 Phillips Head Screwdriver and Hammer
- ✓ Caution: If using a power drill or power screwdriver for screwing, please be aware of to slow down and stop when screw is tight. Failure to do so may result in stripping the screw. (Assembly speed can be increased by using electric screwdriver)

Helpful Hints

PEOPLE NEEDED FOR ASSEMBLY: 1-2

- Open your item in the area you plan to keep it to avoid excessive heavy lifting.
- Identify, sort and count the parts before attempting assembly.
- Compression dowels are lightly tapped in with a hammer.
- Slides are labeled with an R (right) and L (left) for proper placement.
- Make sure to always face the point on the top of the Cam Lock towards the outer edge.
- If there is a back panel in the package, please install it to make sure your unit is complete and sturdy.
- Please fix all the screws provided for the back panel which can enhance product stability. If it is difficult to fix it when tightening, it can be fixed with the help of a hammer and then tightened.
- Do NOT use harsh chemicals or abrasive cleaners on this item.
- Never push, pull, or drag your furniture.



Board Identification

Not actual size

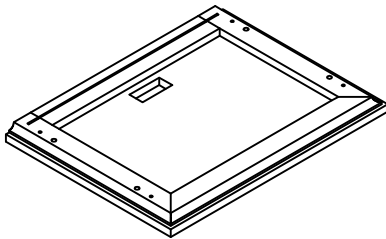

①
TOP
Qty:1

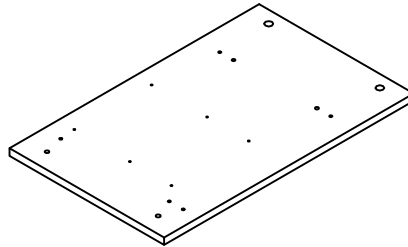

②
LEFT SIDE PANEL
Qty:1

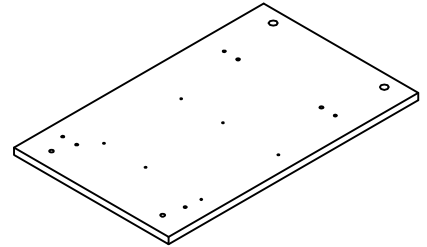

③
RIGHT SIDE PANEL
Qty:1

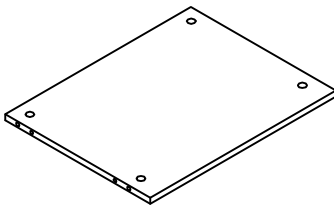

④
FIXED SHELF
Qty:1

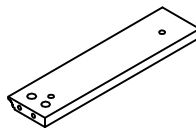

⑤
BOTTOM RAIL
Qty:1

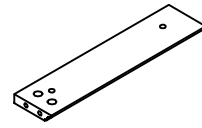

⑥
BOTTOM RAIL
Qty:1

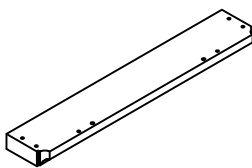

⑦
BOTTOM FRONT RAIL
Qty:1

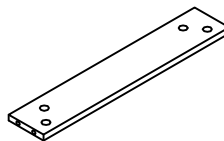

⑧
BOTTOM LINKING RAIL
Qty:1

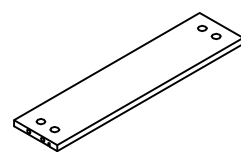

⑨
BOTTOM LINKING RAIL
Qty:1

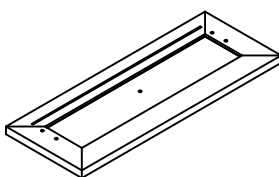

⑩
DRAWER FRONT
Qty:2

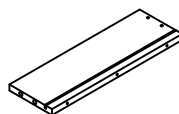

⑪
DRAWER LEFT PANEL
Qty:2

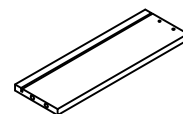

⑫
DRAWER RIGHT PANEL
Qty:2

Board Identification

Not actual size

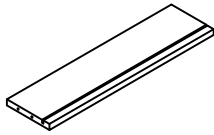

⑬

DRAWER BACK PANEL
Qty:2

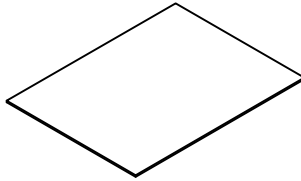

⑭

BOTTOM OF DRAWER
Qty:2

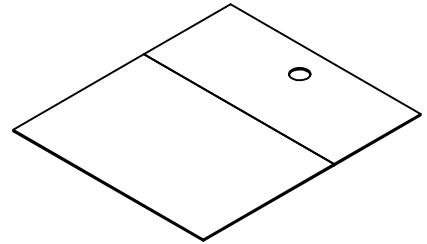

⑮

BACK PANEL
Qty:1

Board Identification

Not actual size

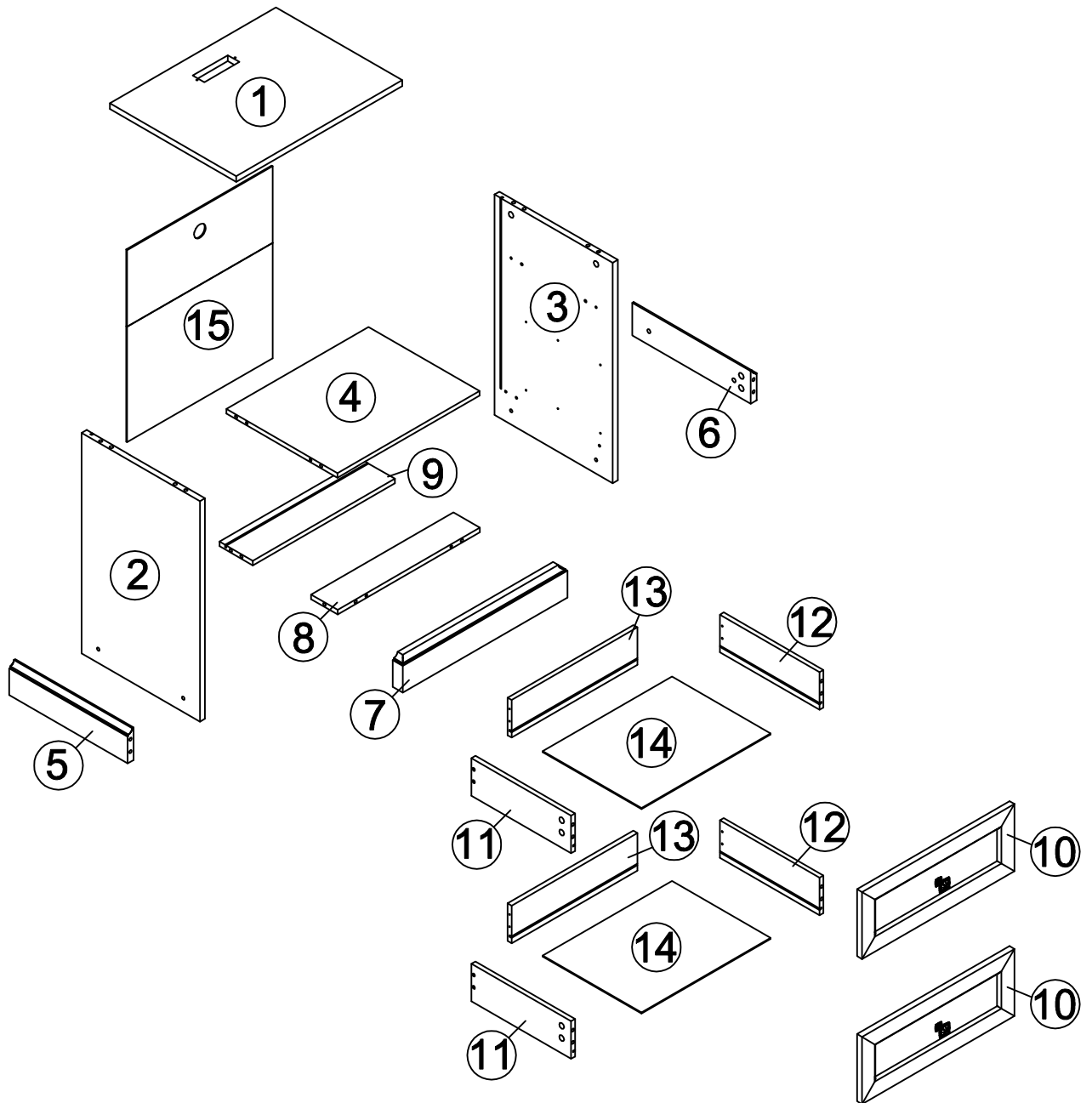

Part List

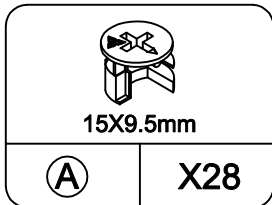

CAM LOCK
spare:2

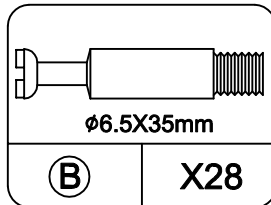

CAM BOLT
spare:2

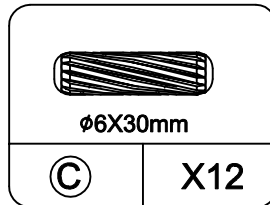

WOOD DOWEL
spare:2

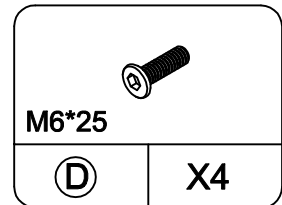

SCREW
spare:1

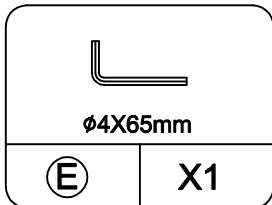

HEX KEY

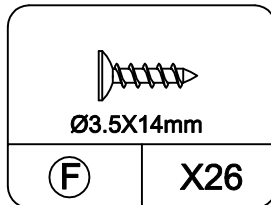

SCREW
spare:2

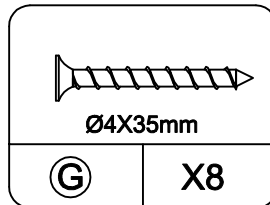

SCREW
spare:1

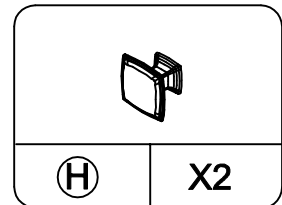

HANDLE

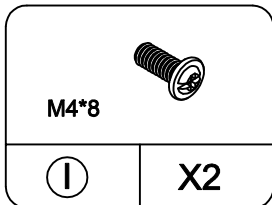

SCREW
spare:1

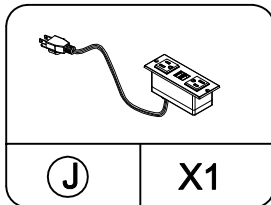

PLUG BOARD

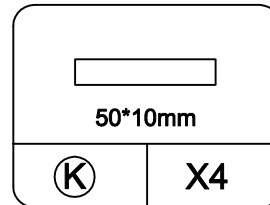

FLOOR-MATS
spare:1

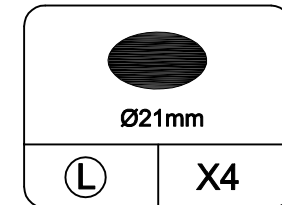

PERFECT STICKERS
spare:2

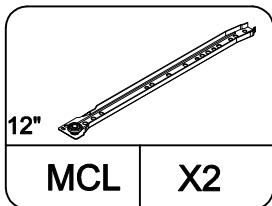

LEFT CABINET MEMBER

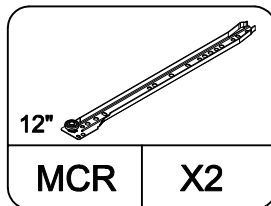

RIGHT CABINET MEMBER

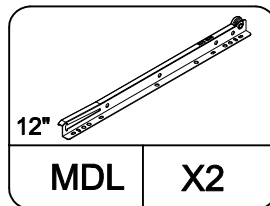

LEFT DRAWER RUNNER

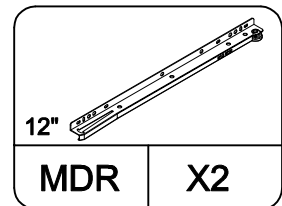

RIGHT DRAWER RUNNER

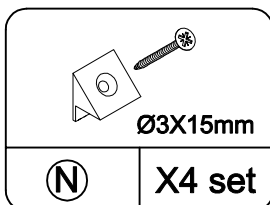

BACK PANEL BUCKLE
spare:1

Cam Lock Fastening System

Insert the cam bolt into the hole first, then insert the cam lock and lock it.

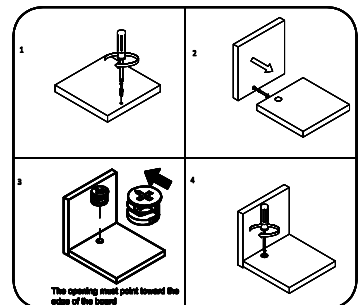

STEP 1

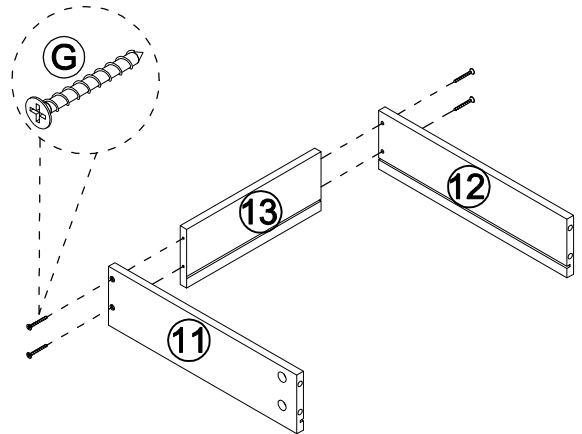
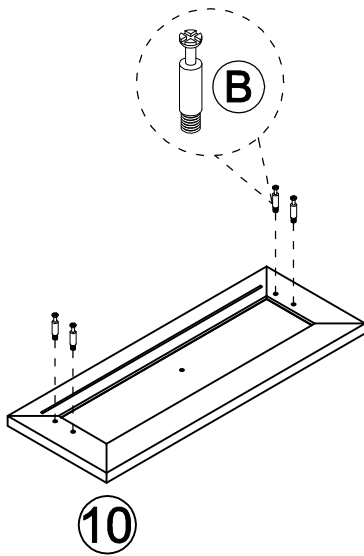
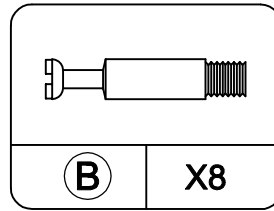
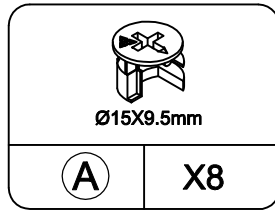
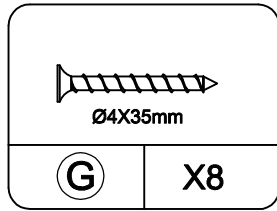
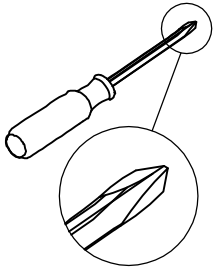

X 2

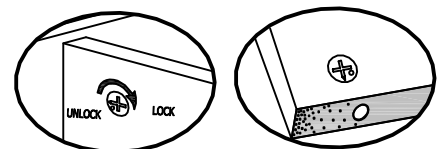
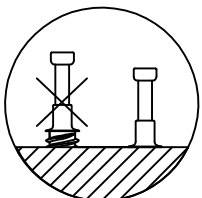
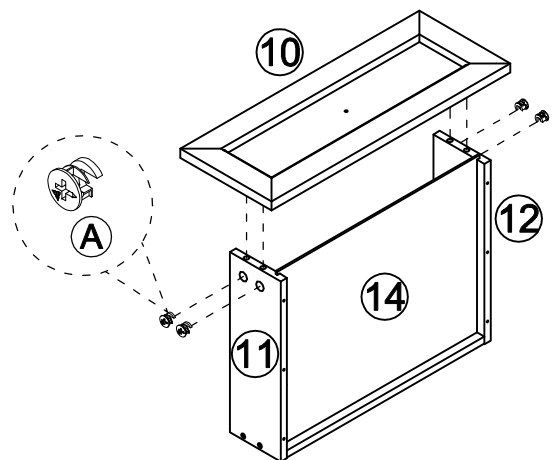
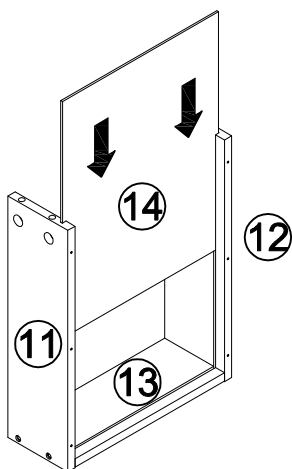

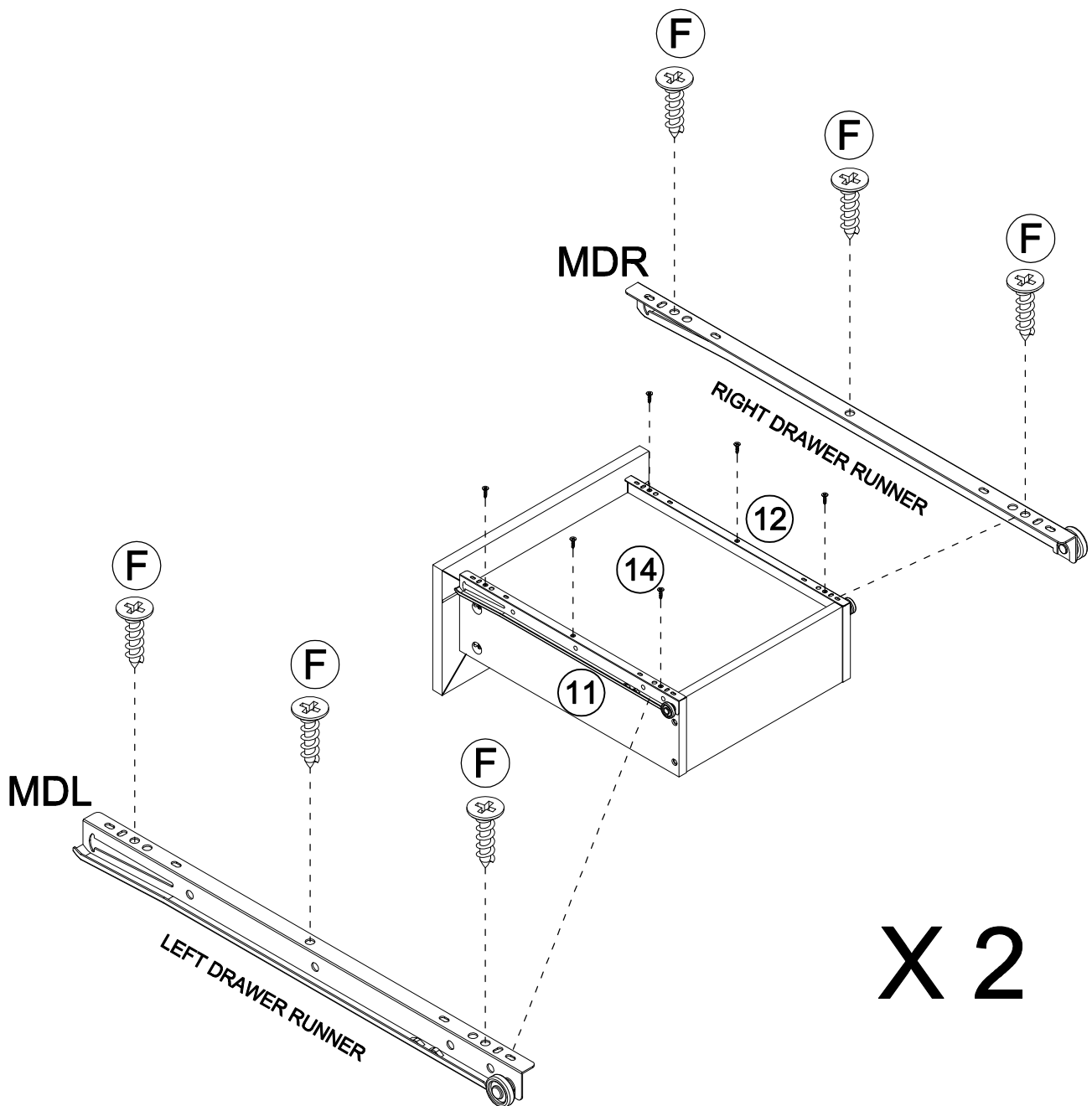
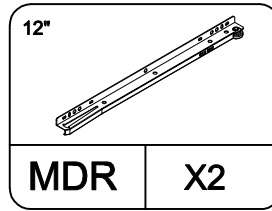
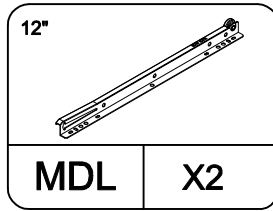
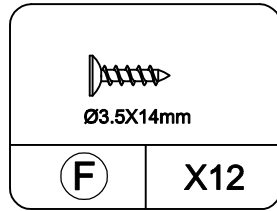
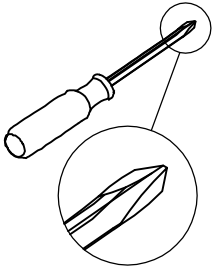

Proper orientation of CAM LOCK

STEP 2

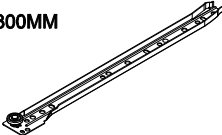
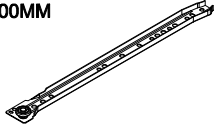
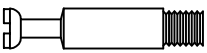

STEP3

 <p>Ø6X30mm</p>		 <p>Ø3.5X14mm</p>		 <p>300MM</p>		 <p>300MM</p>			
(C)	X4	(F)	X12	MCR	X2	MCL	X2	(B)	X10

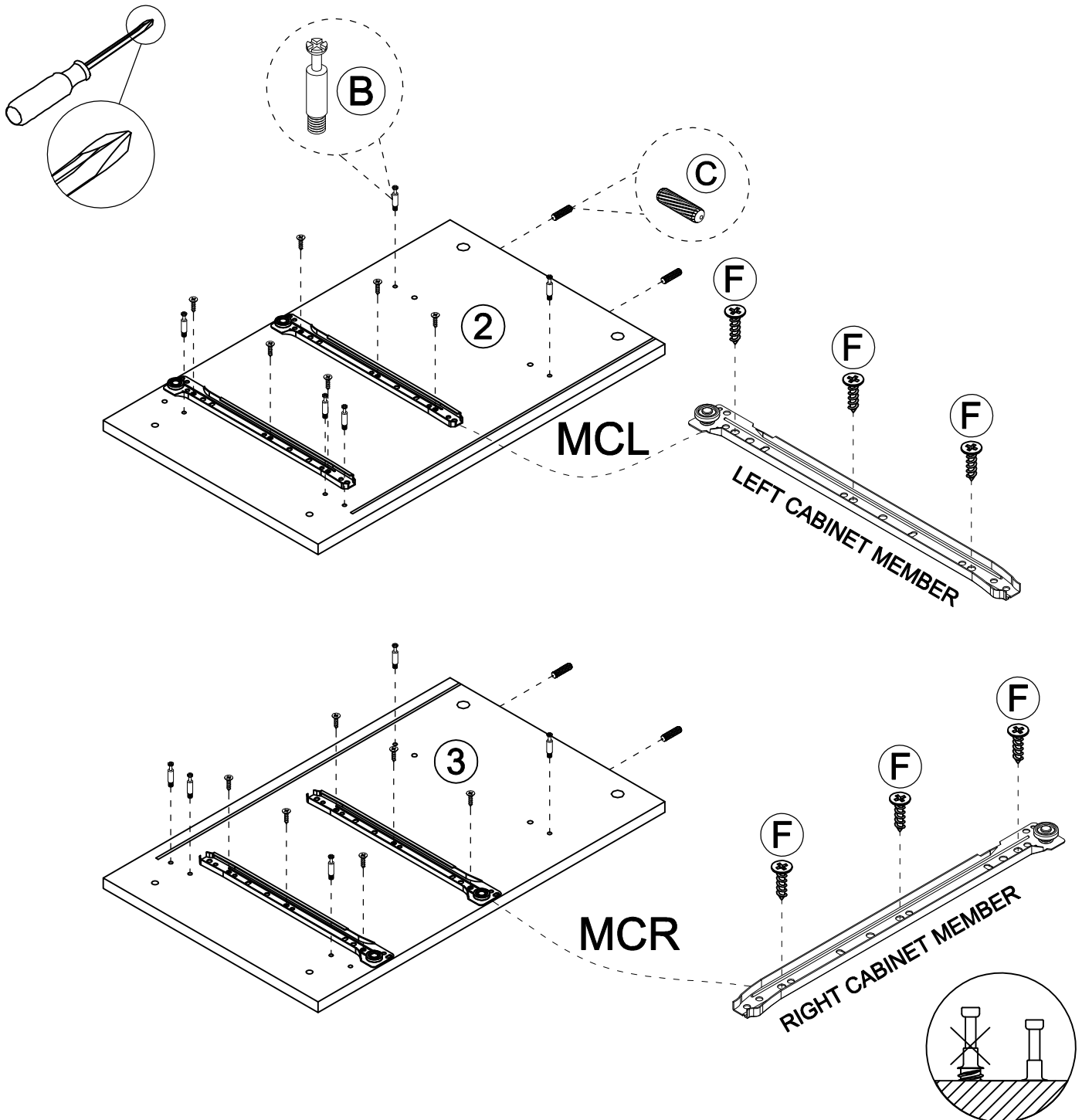

STEP 4

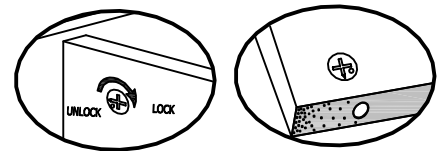
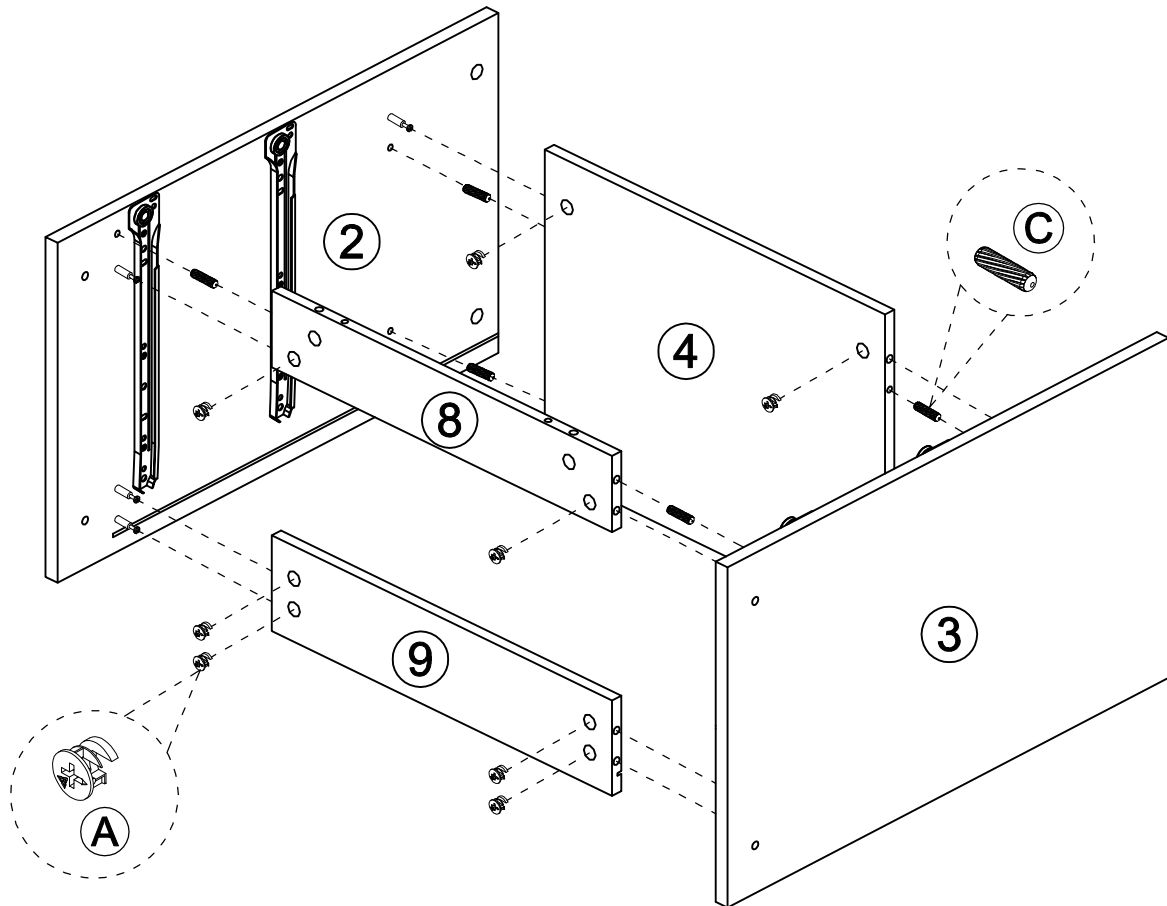
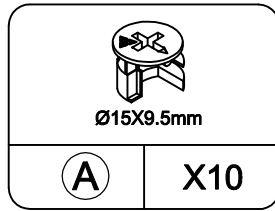
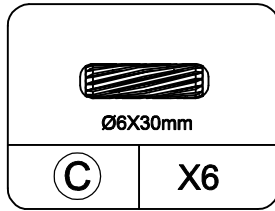
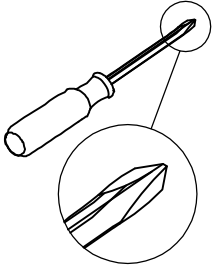

STEP5

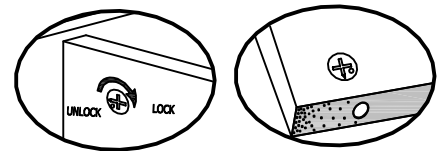
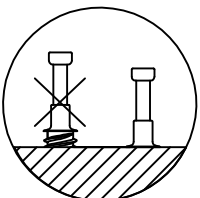
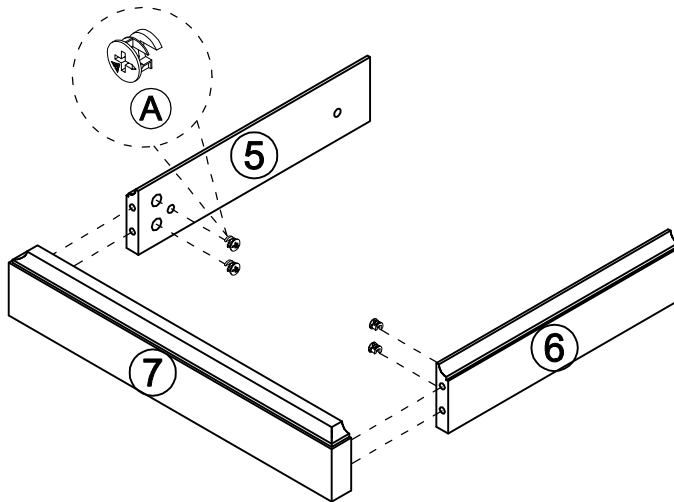
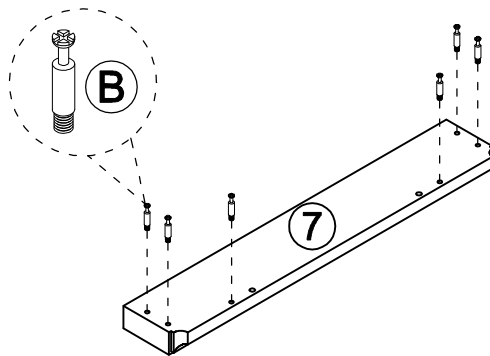
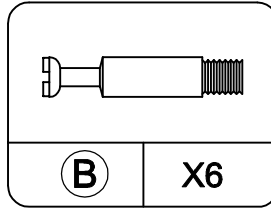
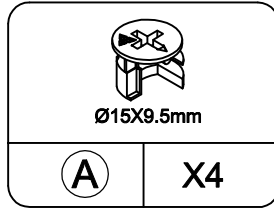
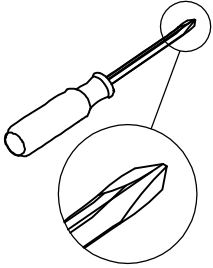

STEP 6

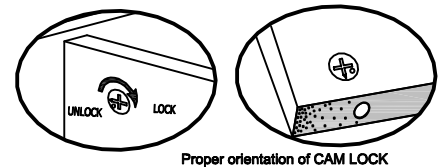
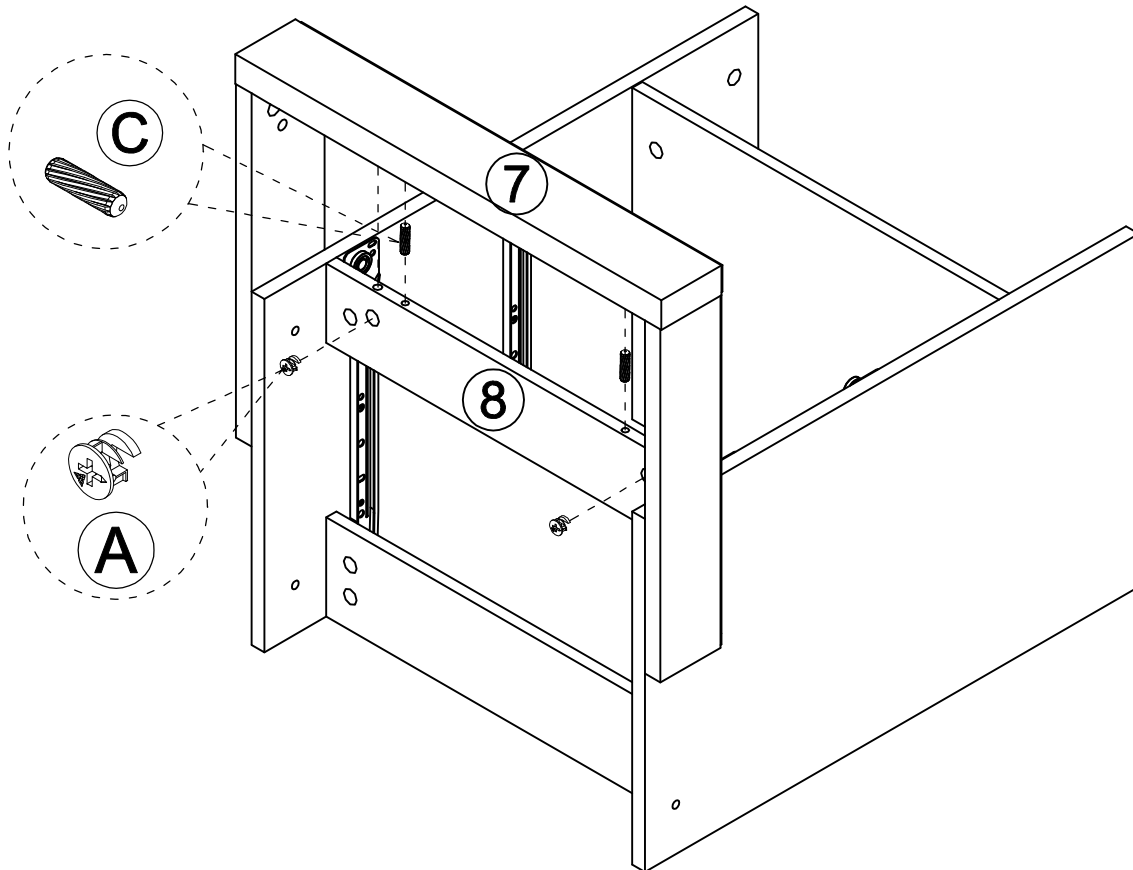
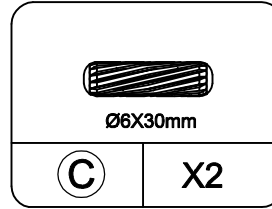
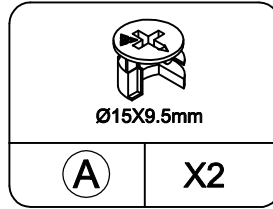
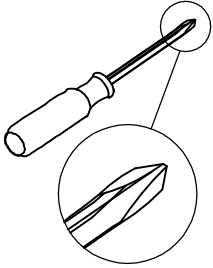

STEP 7

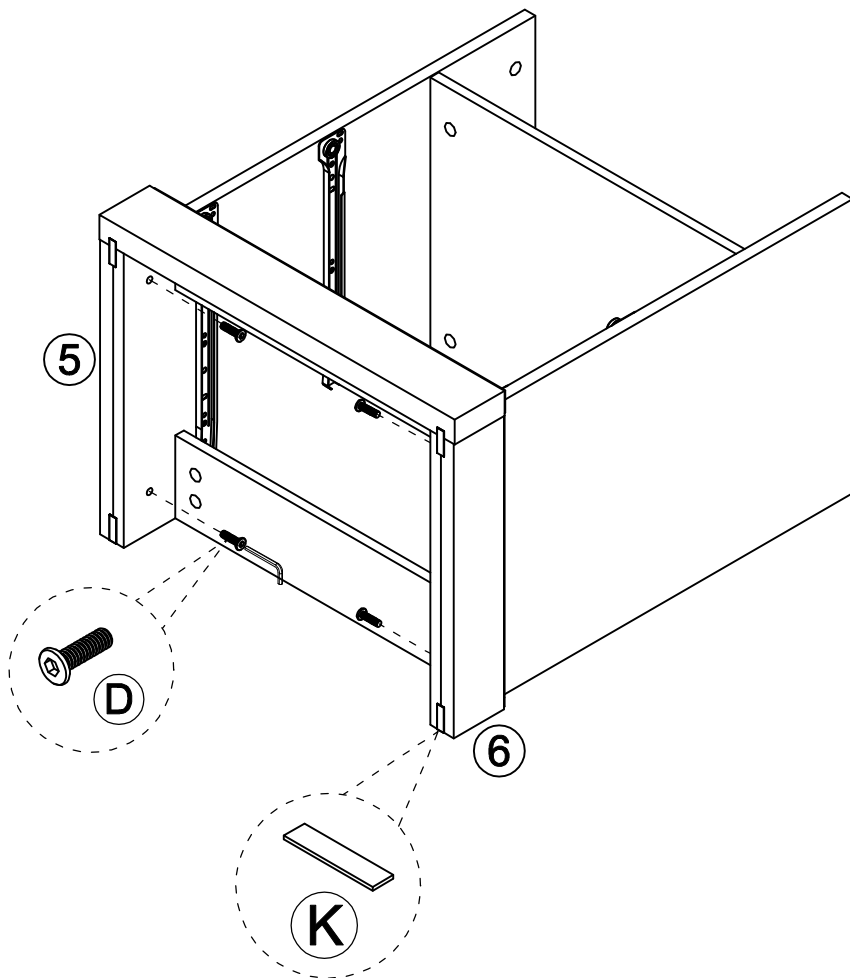
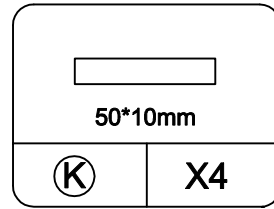
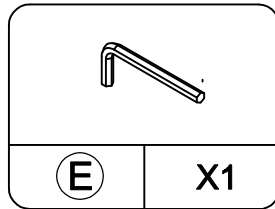
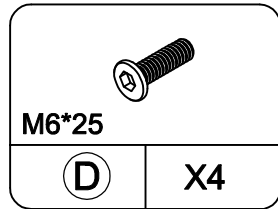
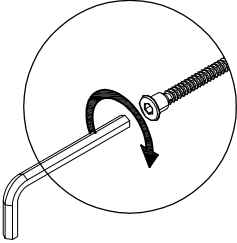

**Tear the layer off
then stick it on the
side panel**

STEP 8

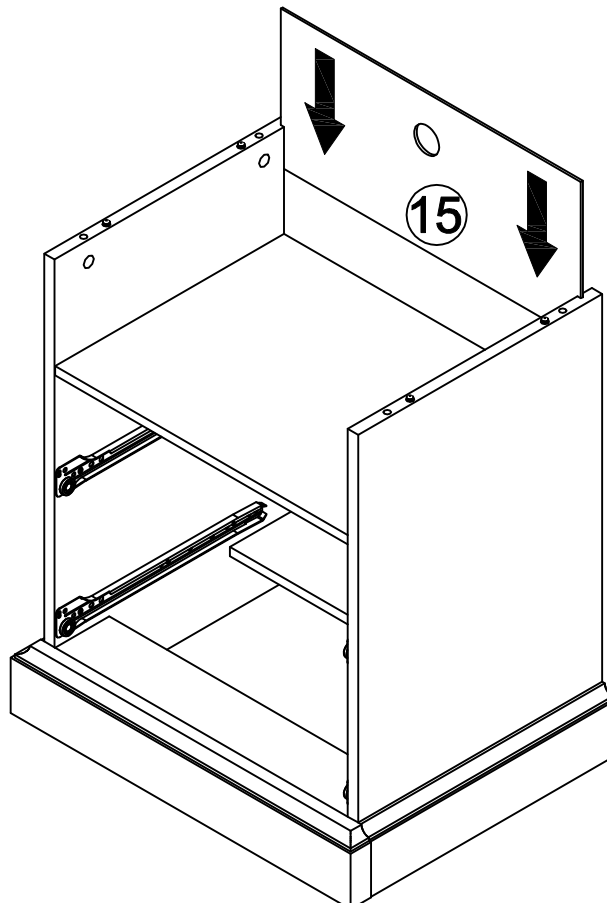
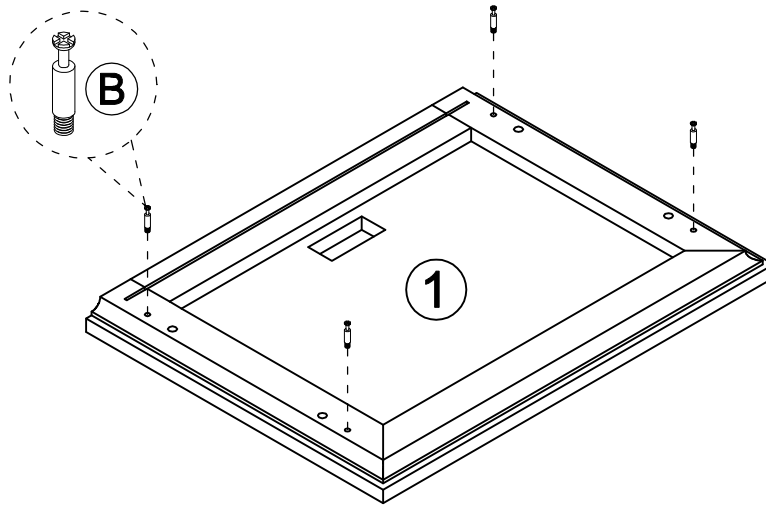
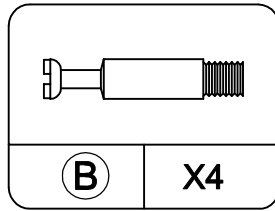
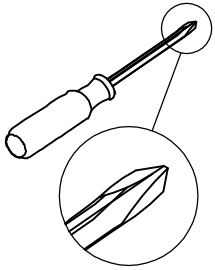



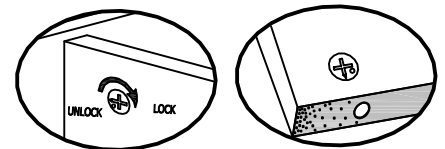
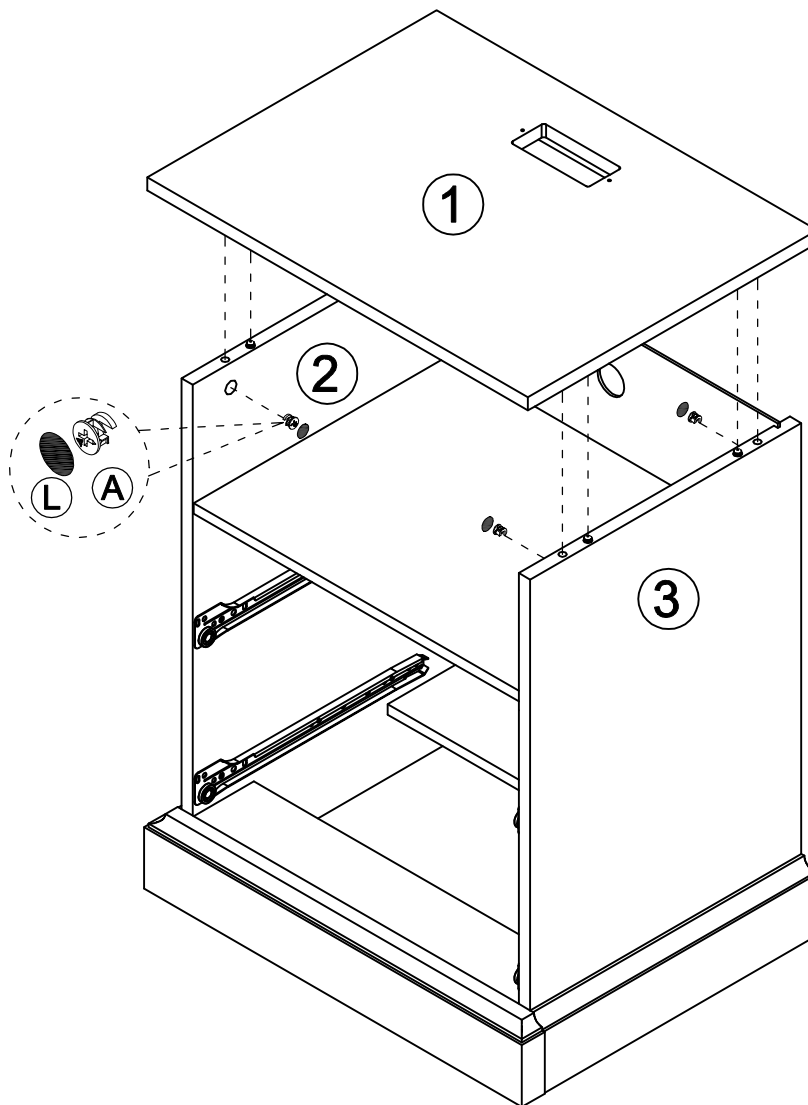
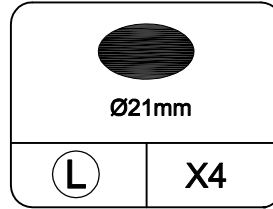
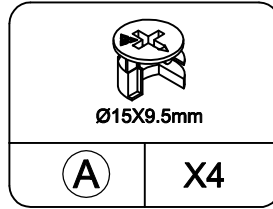
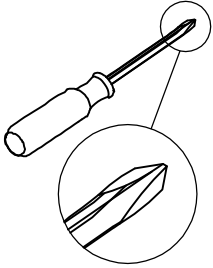

STEP 9

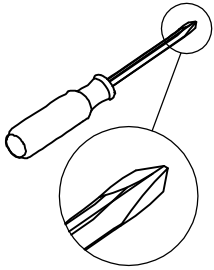

Proper orientation of CAM LOCK

STEP10

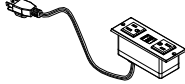

							
(H)	X2	(I)	X2	(J)	X1	(F)	X2

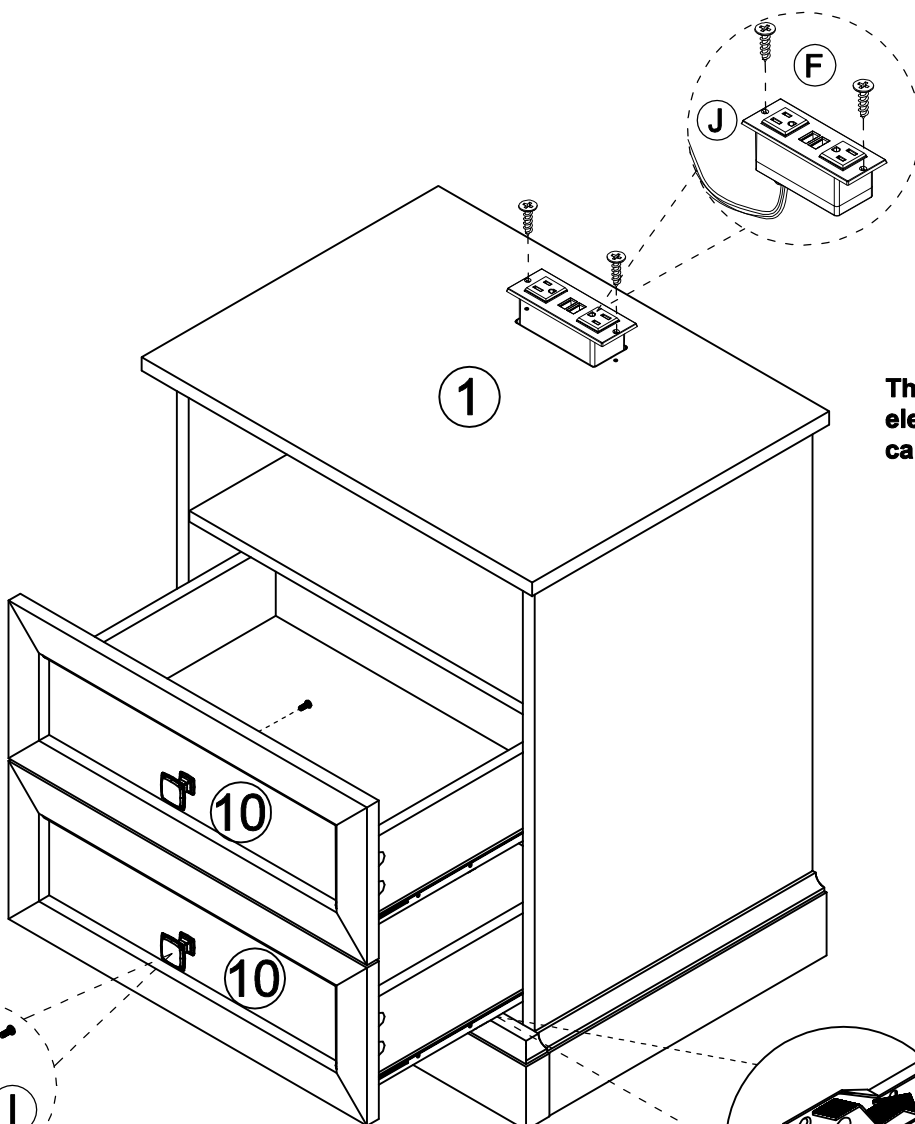

The power of using electrical appliances cannot exceed 1500W

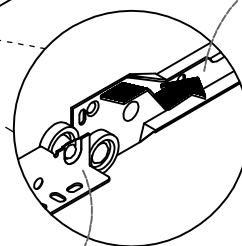
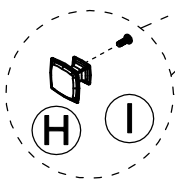

Drawer Slide

Cabinet Slide

STEP11

