

# VICLLAX Build Your Dream Patio

## USE AND CARE GUIDE

Scan The Code for Assembly  
Guide Video



Youtube



KDCS01



vicllax.com

Visit our website: <https://www.vicllax.com/> for more products or  
contact us by email: [service@vicllax.com](mailto:service@vicllax.com)

*Thank you for choosing VICLLAX*



# PATIO

## life

Outdoor patio furniture comes in many styles, colors, and textures, so you can indeed create your own ideal patio life.





# Table of Contents

Contents .....	1	Pre-assembly .....	3
Safety Information .....	2	Assembly .....	4-6
Warranty .....	2	Care And Maintenance .....	7
What is Covered .....	2		
What is Not Covered .....	2		

## Safety Information

- Do not completely tighten screws until all screws are started. Tighten each bolt firmly and properly.
- Some parts may contain sharp edges. Wear protective gloves as necessary.
- Children under the age of 16 should not be engaged in the assembly, removal or disassembly of the product. Children under the age of 10 should be supervised by a competent adult while using this furniture.
- Please keep children out of the assembly area during assembly.
- This set is heavy, and may require two adults for safe assembly.
- Never use this product as a support. Do not shake, lean, or climb on the product at any time.

 **DANGER** : Do not allow children to play with plastic wraps or small parts to prevent potential choking hazard.

 **CAUTION**: Read all the instructions before assembly. Failure to do so may result in faulty assembly and potential injury!

## Warranty

### LIMITED WARRANTY

This warranty is a limited warranty, and applies to the original purchase is required. This is a residential warranty and does not apply to commercial use. This collection carries a (1) year limited warranty and is valid from original date of purchase to the original owner (proof of purchase required).

### WHAT IS COVERED

We warrant the frame to be free of Manufacturing defects to the original purchaser for one year.

### WHAT IS NOT COVERED

This warranty does not cover commercial use, hardware, acts of nature, fire, freezing and abusive.

















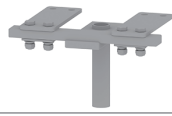

In addition, purchased parts are not covered under this warranty.

We reserve the right to make substitutions with similar merchandise, if the model in question is no longer in production.

# Pre-assembly (continued)

Assemble the item on a soft non-abrasive surface, such as carpet or cardboard to avoid damaging the item. Seek assistance to assemble bulky or heavy items.

**NOTE:** Identify all parts packed in the carton against the parts list.  
Remove all the protective material carefully and DO NOT use a knife to prevent scratching the furniture.

A		<b>1pc</b>	B		<b>1pc</b>
C		<b>1pc</b>	D		<b>1pc</b>
E		<b>3pc</b>	F		<b>1pc</b>
G		<b>1pc</b>	H		<b>1pc</b>
I		<b>2pc</b>	J	 M8*32	<b>4pc</b>
K	 M6*30	<b>8pc</b>	L	 M6*18	<b>6pc</b>
M	 M6*15	<b>6pc</b>	N	 M8	<b>4pc</b>
O	 M8	<b>4pc</b>	P	 M8	<b>4pc</b>
Q	 M6	<b>20pc</b>	R	 M6	<b>6pc</b>
S		<b>1pc</b>	T		<b>1pc</b>

# Assembly

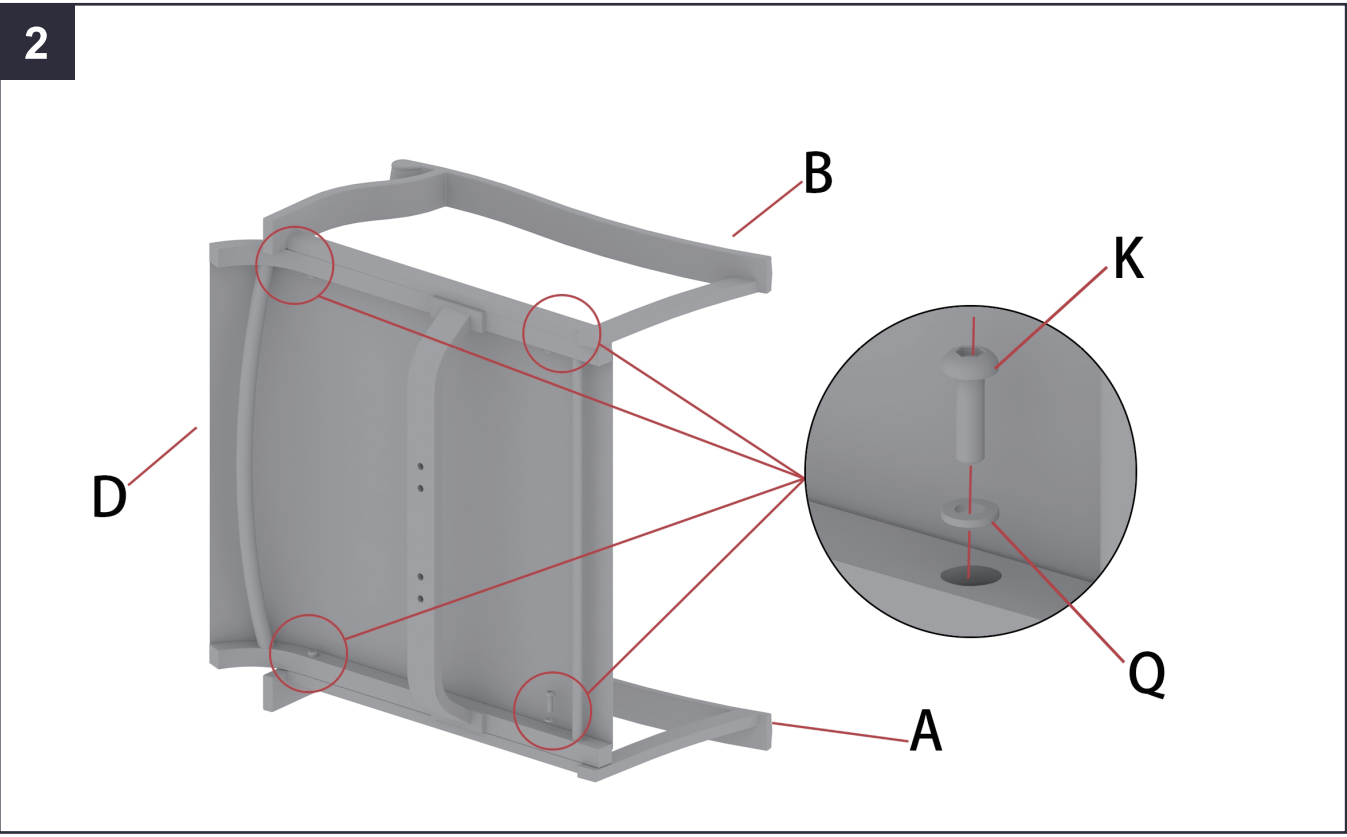
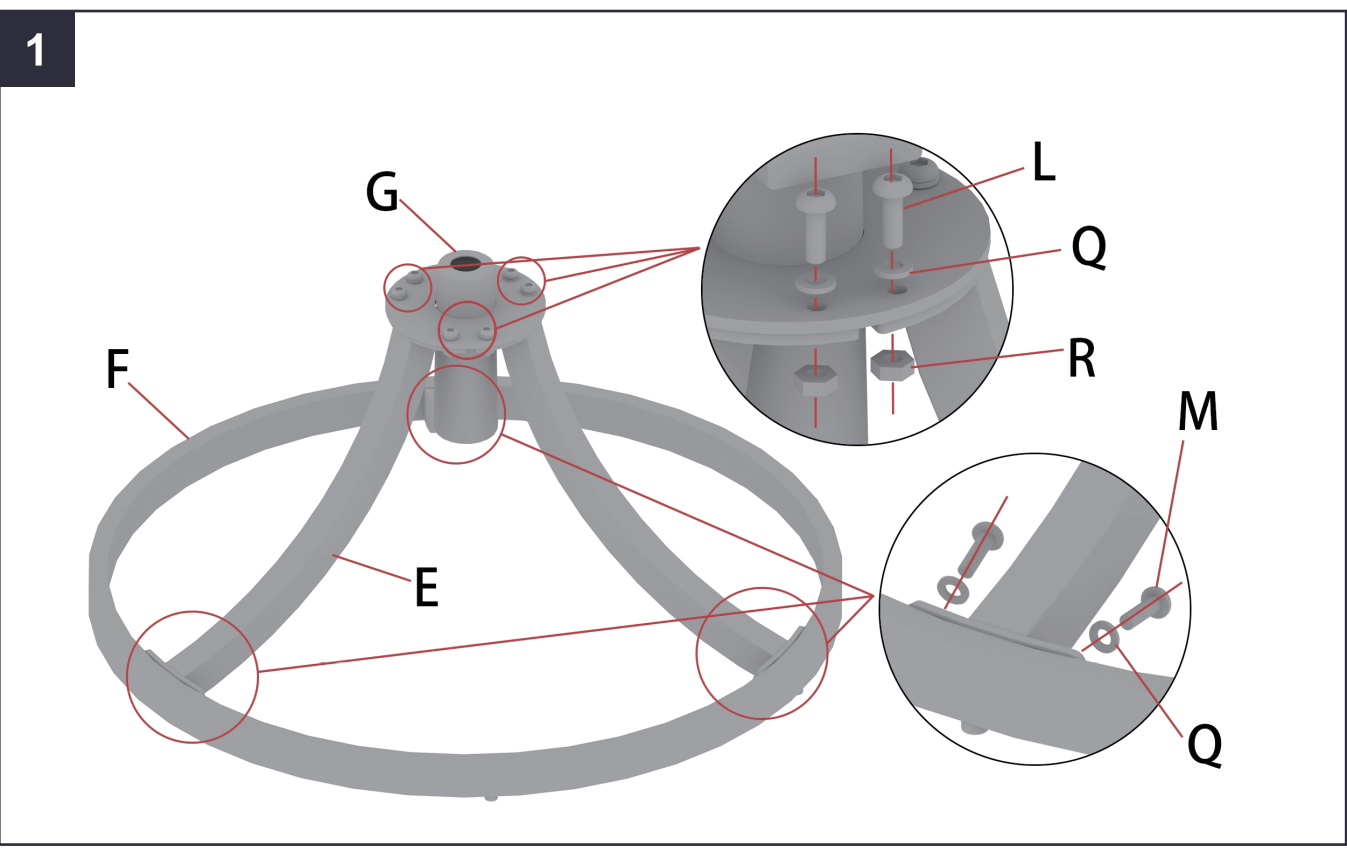

# Assembly

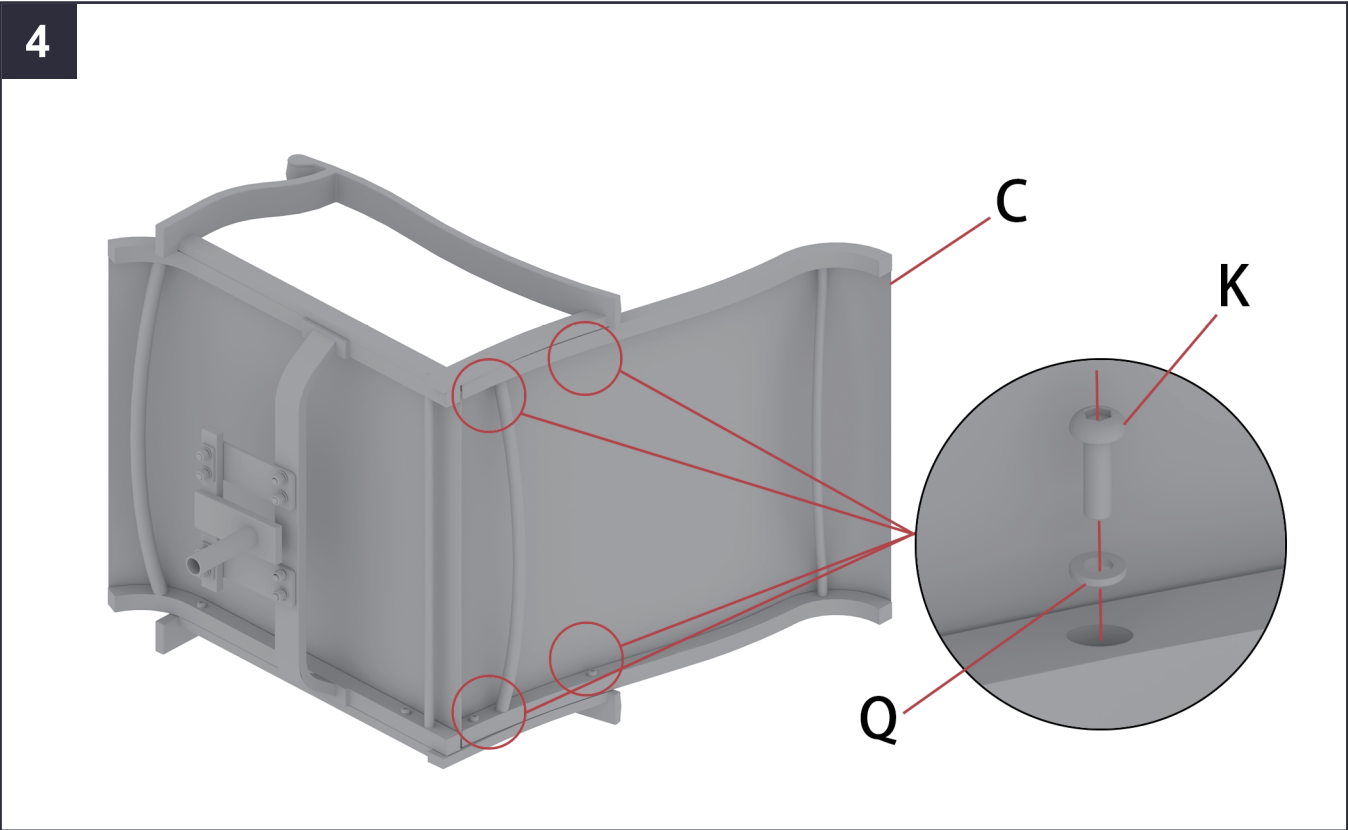
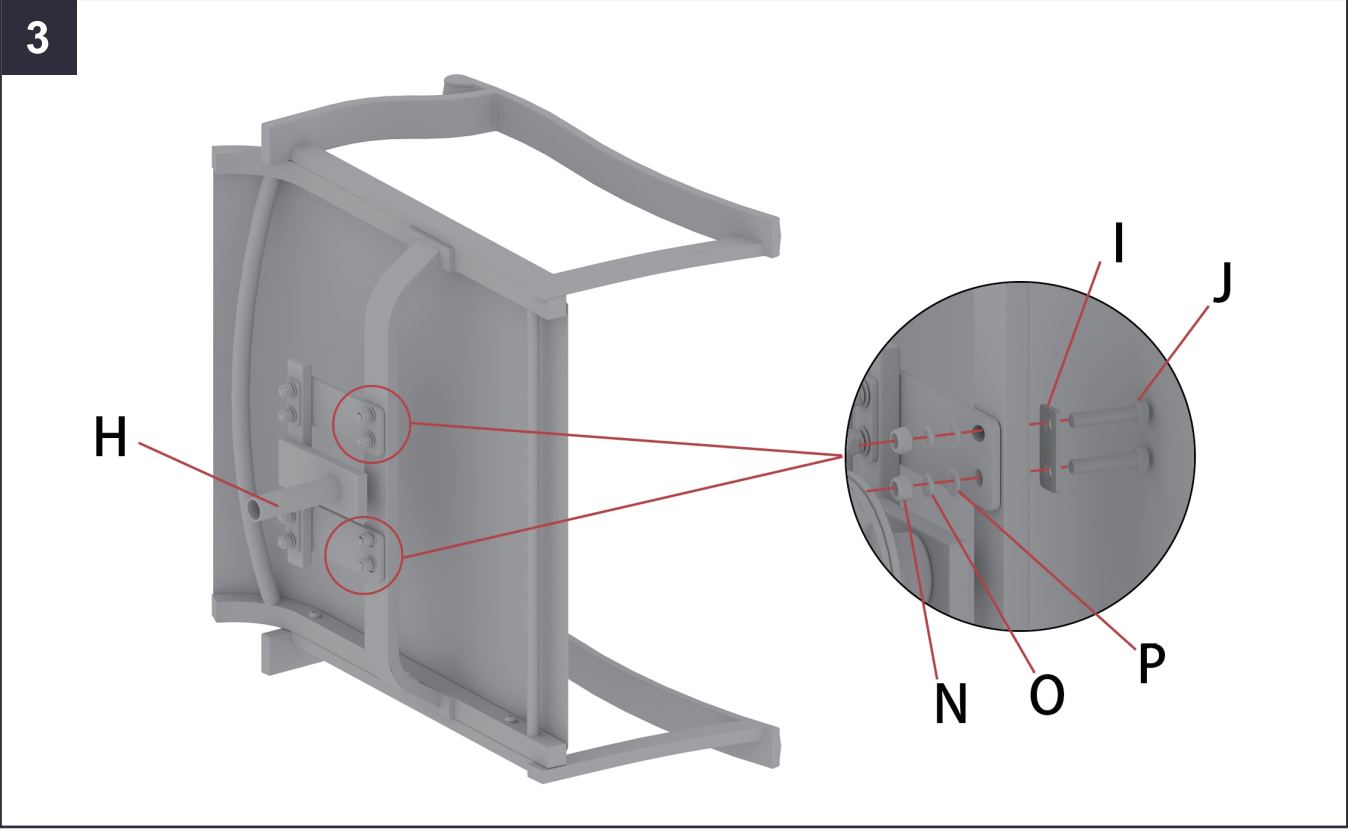



## Cleaning and Maintenance

---

1. Clean the furniture with damp cloth, rinse thoroughly. Dry frame parts completely. Do not use bleach, acid or other solvents on the wicker or metal parts.
2. We recommend the use of furniture covers to protect the product when not in use.
3. Inspect and tighten all SCREW on a regular basis to ensure proper performance and safety.
4. In order to prolong the life and beauty of your Item, we recommend storing it in a dry and protected area during off season periods.

**VICLLAX**

If there is any confusion, please do not hesitate to share with us.

[service@vicllax.com](mailto:service@vicllax.com)