

# ASSEMBLY INSTRUCTIONS

MODEL #

**FM7369AK-D**

Questions?

GIVE US A CALL: 1-888-980-5122  
MON-FRI 8:30AM - 5:30PM (PT)

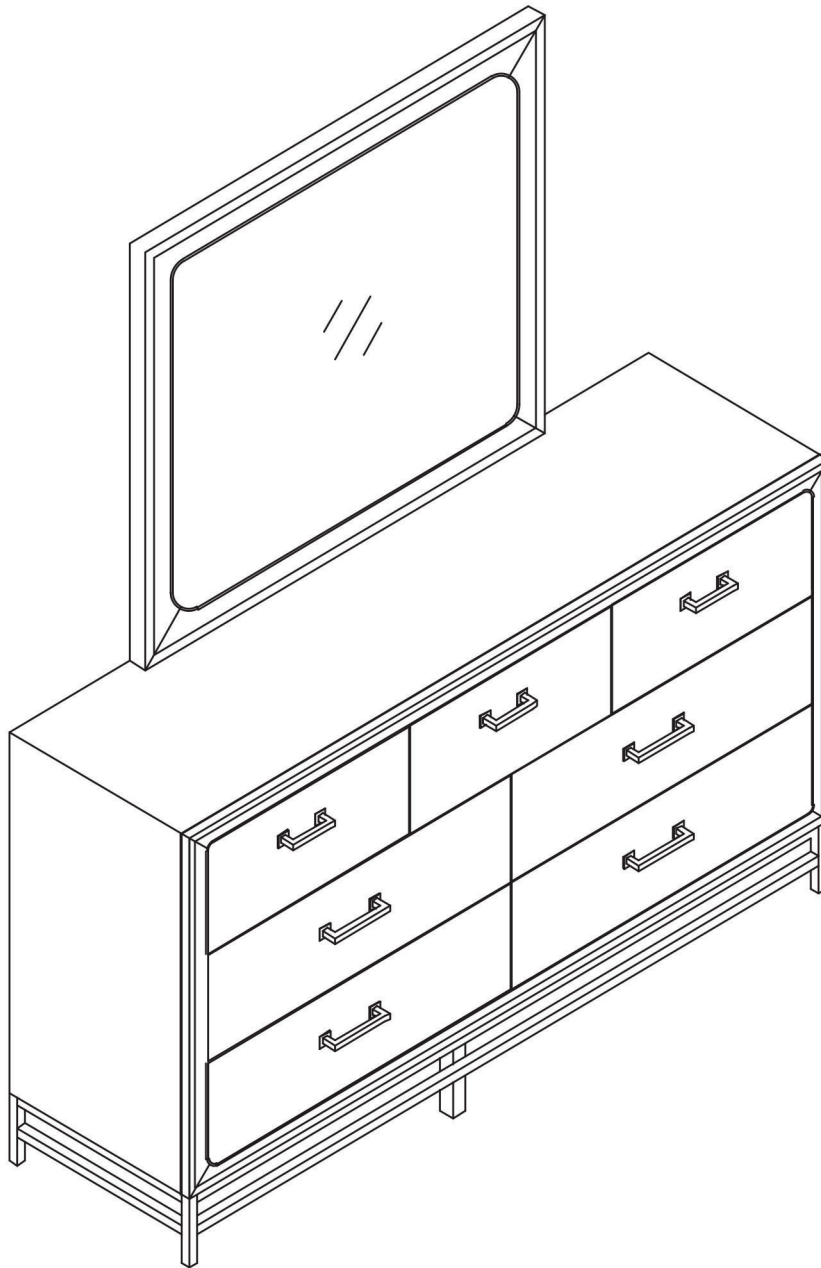

## TOOLS REQUIRED



Allen Key  
(Included)



2 People

## ASSEMBLY RATING

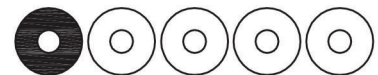

EASY → DIFFICULT

The Assembly Rating is a 5-point system showing the level of effort needed to assemble a specific product.



Thank you for your purchase!

We hope you enjoy this new addition to your home for many years to come.

Our commitment to providing quality products does not simply end when you purchase our product. We fully stand behind our products from start to finish. Our customer service department is available Monday – Friday 8:30 AM – 5:30 PM Pacific Time and can help with assembly questions as well as, if necessary, replacing damaged or missing parts. To help expedite our service, please have these assembly instructions readily available, along with your order receipt.



**Consumer Hotline**  
Toll-Free 1-888-980-5122



**Monday to Friday**  
8:30AM- 5:30PM (PT)



**WEBSITE**  
[www.foagroup.com](http://www.foagroup.com)



**E-MAIL**  
[cs.ec@foagroup.com](mailto:cs.ec@foagroup.com)



foagroup



FurnitureOfAmerica



## CHECK BEFORE STARTING

### Are you missing anything?

Double-check all parts, hardware and accessories listed are all accounted for.

### Check out our Quick Tips!

We recommend reviewing the pre-assembly handouts. Even experts need a refresher now and then!

### Should we send any replacements?

Are there any irregularities or flaws in the parts? We can send replacements!

### Prep Time!

Please review the assembly instructions and all diagrams prior to assembling.

# PRE ASSEMBLY INTRODUCTION

We understand building ready-to-assemble furniture can be a challenging experience for some. To help avoid confusion, we have provided some helpful tips that may speed up the process.

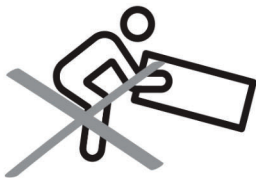

## Teamwork

ALWAYS have at least two people to help with transporting and assembling the product to avoid potential injury and/or damage.

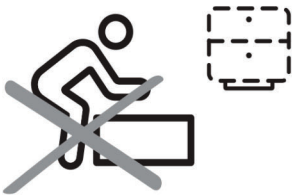

## Suitable Location

Assembling near the area of the intended location is highly recommended.



## Sufficient Space

Make sure you have enough space to move around during the assembly.



## Avoid Scratches

Use cardboard, blankets or a carpeted area while assembling furniture to prevent to prevent scratches and damages.



## Flat Surface

Make sure the furniture rests on a flat and level surface with each leg evenly touching the floor.

# ASSEMBLY AND CARE ADVICE



**FAILURE TO FOLLOW THE GUIDELINES BELOW MAY RESULT IN INJURY AND/OR PROPERTY DAMAGE.**



Position each part correctly and insert screws or bolts into their respective holes.

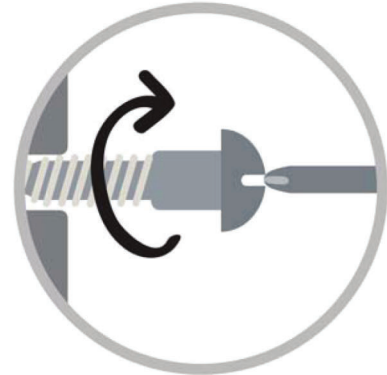

Turn clockwise to tighten and only tighten when step is completed or when instructed to do so.



Use the appropriate hand tools or power tools for assembly. Select steps, such as tightening screws and/or bolts, may require hand tools to avoid causing damage during assembly.



Save the instructions and store any supplied tools for later maintenance.



After two weeks, check and tighten any loose hardware and repeat again every six months thereafter.

**IT IS THE USER'S RESPONSIBILITY TO MAINTAIN THE FURNITURE. THE HARDWARE MAY LOOSEN OVER TIME AND MAY CAUSE THE FURNITURE TO BE WOBBLY AND UNABLE TO SUPPORT ITS INTENDED WEIGHT CAPACITY. THIS MAY LEAD TO COLLAPSE AND MAY CAUSE SERIOUS INJURY.**

# DRESSER

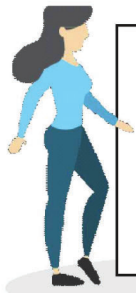

- Please keep instructions for future reference.
- Check the quantity and irregularity of parts and hardware before you start.

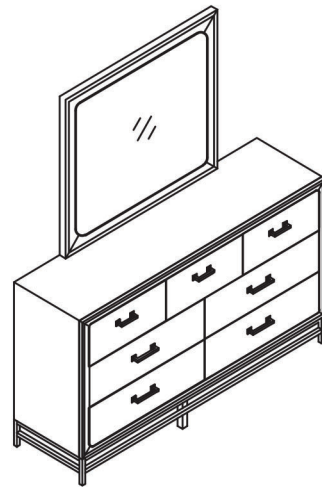

## PARTS

Ⓐ

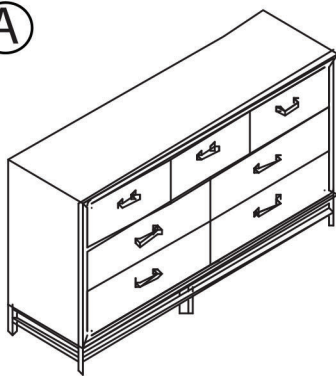

DRESSER  
1 pc.

Ⓑ

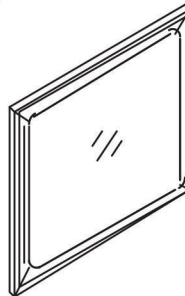

MIRROR  
1 pc.

Ⓒ

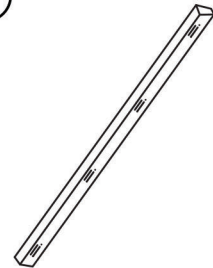

SUPPORT SLATS  
2 pcs.

## HARDWARE

①



ALLEN KEY M4\*58MM  
1 pc.

②



FLAT HEAD BOLT  
Ø1/4"\*1-1/2"  
8 pc.

③

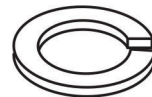

SPRING WASHER  
Ø1/4"\*12\*2MM  
8 pc.

④



FLAT WASHER  
Ø1/4"\*19\*2MM  
8 pc.

⑤

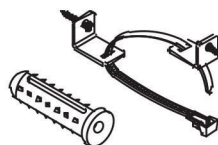

ANTI-TIP KIT  
1 set

# ASSEMBLY INSTRUCTIONS

1

#2x 8pcs

#3x 8pcs

#4x 8pcs

I. Secure Lower end of the Support Slats (#C) to the dresser (#A) by using Bolt (#2) with Spring washer (#3) and Flat washer (#4). Align the Mirror (#B) to the Upper end of the Support Slats (#C) and secure by using Bolt (#2) with Spring washer (#3) and Flat washer (#4).

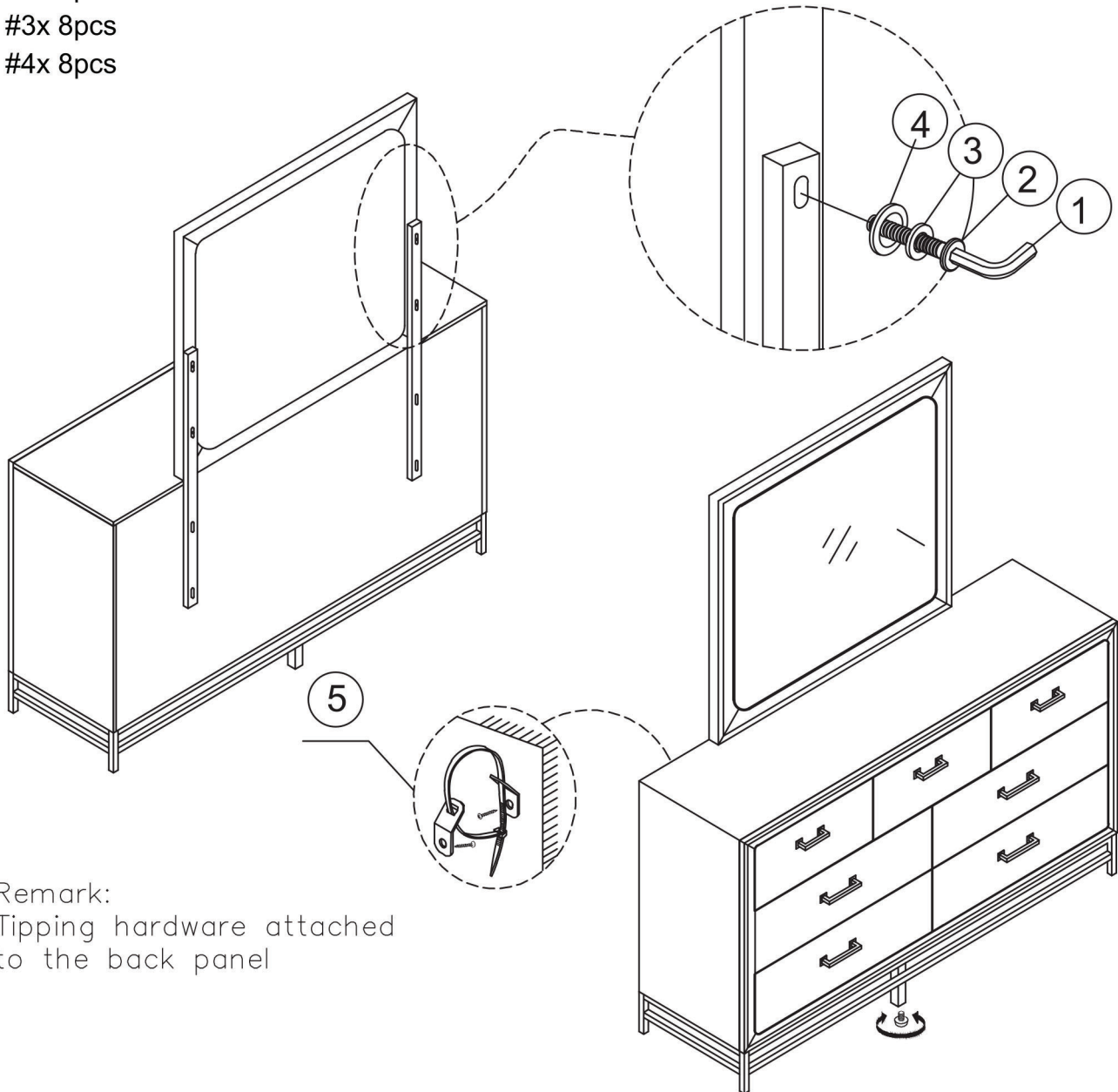

Remark:  
Tipping hardware attached  
to the back panel

II. Use Anti-tip kit (#5) to attach the top  
of the dresser (#A) to the wall.

III. Move adjuster on the center support  
leg to level the leg to the floor.

# ASSEMBLY INSTRUCTIONS

2

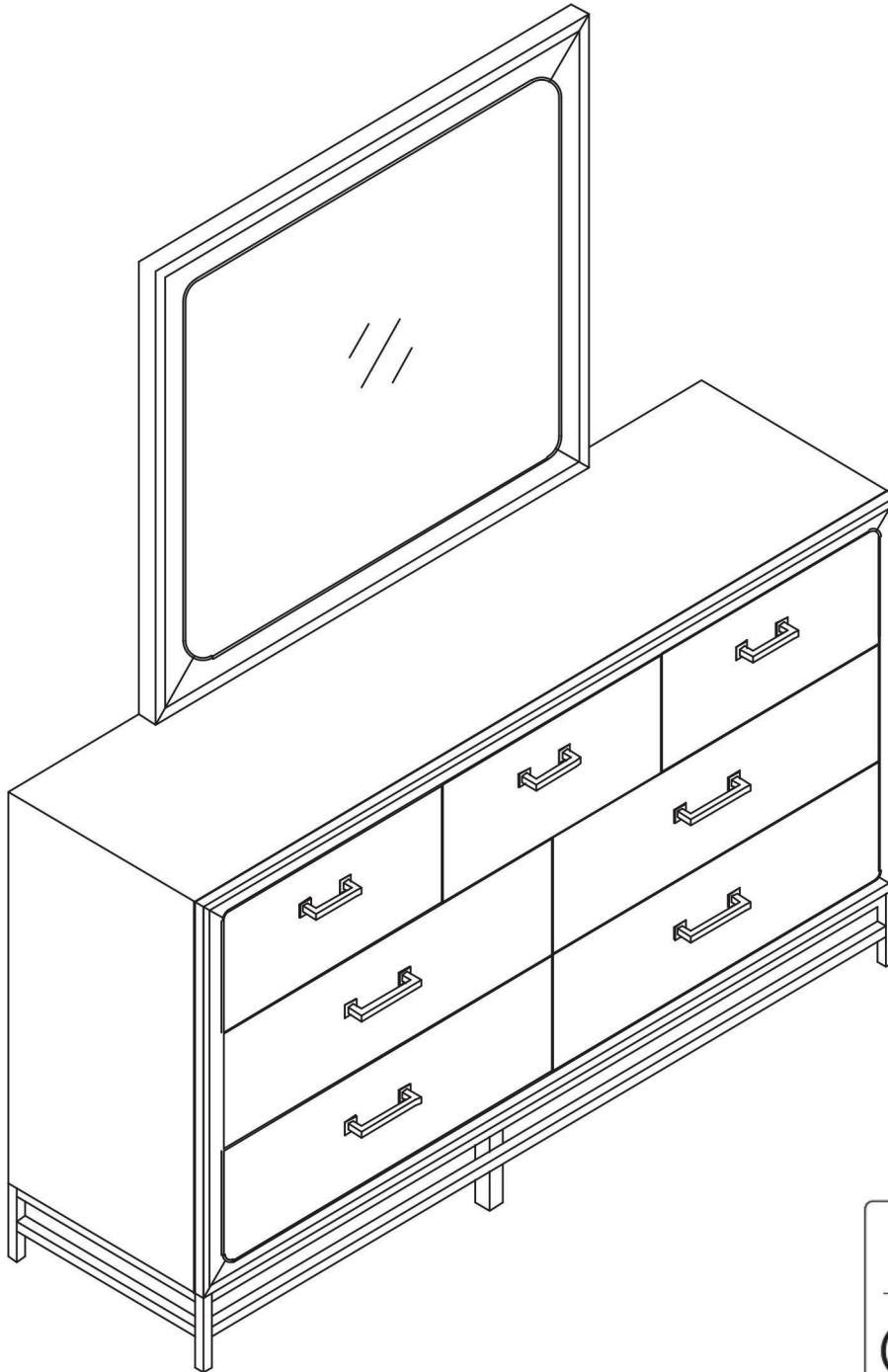

## ASSEMBLY COMPLETED



Please ensure the furniture rests on an even and flat surface. If the product wobbles or feels loose, double-check all bolts and/or screws are properly tightened and secured.



### Keep this handy!

Please retain this instruction manual and any order-related information for future reference.



### Lift, don't drag!

To avoid damage to product please always LIFT the product when transporting or adjusting the placement.

# ASSEMBLY INSTRUCTIONS

## Wall Mounting and Fixing



### EXPANSION WALL ANCHOR

Our provided expansion wall anchors are only suitable for masonry walls, such as drywall, plaster or concrete, and are best for holding lightweight items or for anti-tip prevention. If you are unsure of the correct wall anchor to use with the product, please request professional guidance. Liability for product damage or failure due to using the incorrect anchors will fall on the installer.

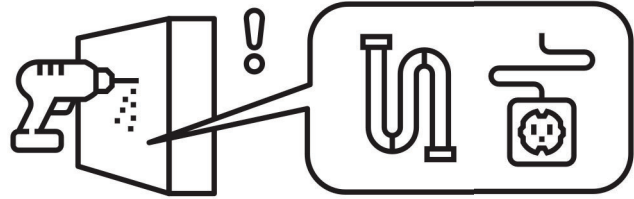

### CHECK BEFORE PROCEEDING

Prior to drilling or hammering, please check for wires or pipes. We recommend using a stud finder to locate a stud, which will offer more appropriate resistance and hold more weight.

## QUICK TIPS

1. If unsure of the proper size, always choose a larger screw and wall anchor.

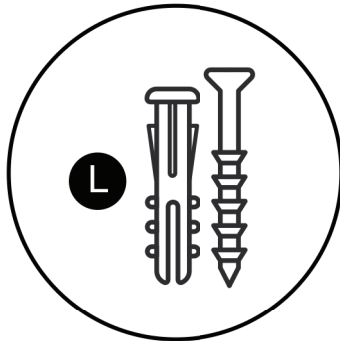

2. Match the drill bit to the wall anchor and hole size.

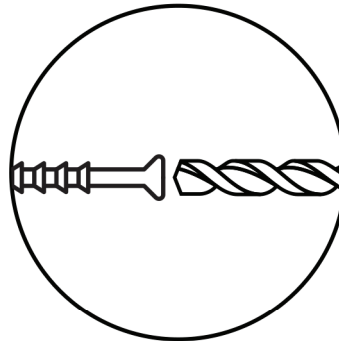

3. Only drill horizontally. Do not force the drill or enlarge the hole for the wall anchor.

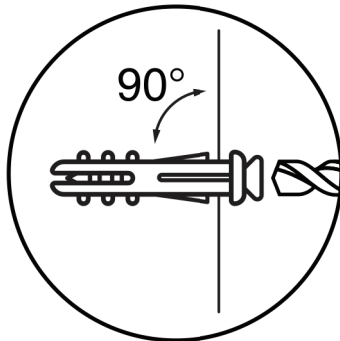

4. Take extra care when drilling into high walls or ceramic tiles. Wall anchors should be a tight fit for the hole. Never use wall anchors in ceilings.

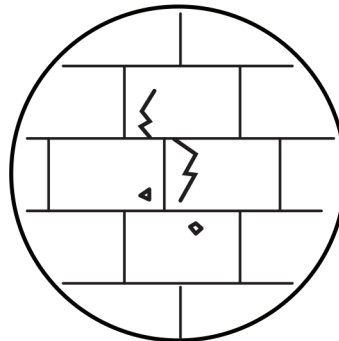

### MAINTENANCE



We recommend a yearly check to see if the wall anchor or screw has loosened. If so, please remove the existing wall anchor and screw, and use a new anchor.

# ASSEMBLY INSTRUCTIONS

MODEL #

**FM7369AK-D**

Questions?

GIVE US A CALL: 1-888-980-5122  
MON-FRI 8:30AM - 5:30PM (PT)

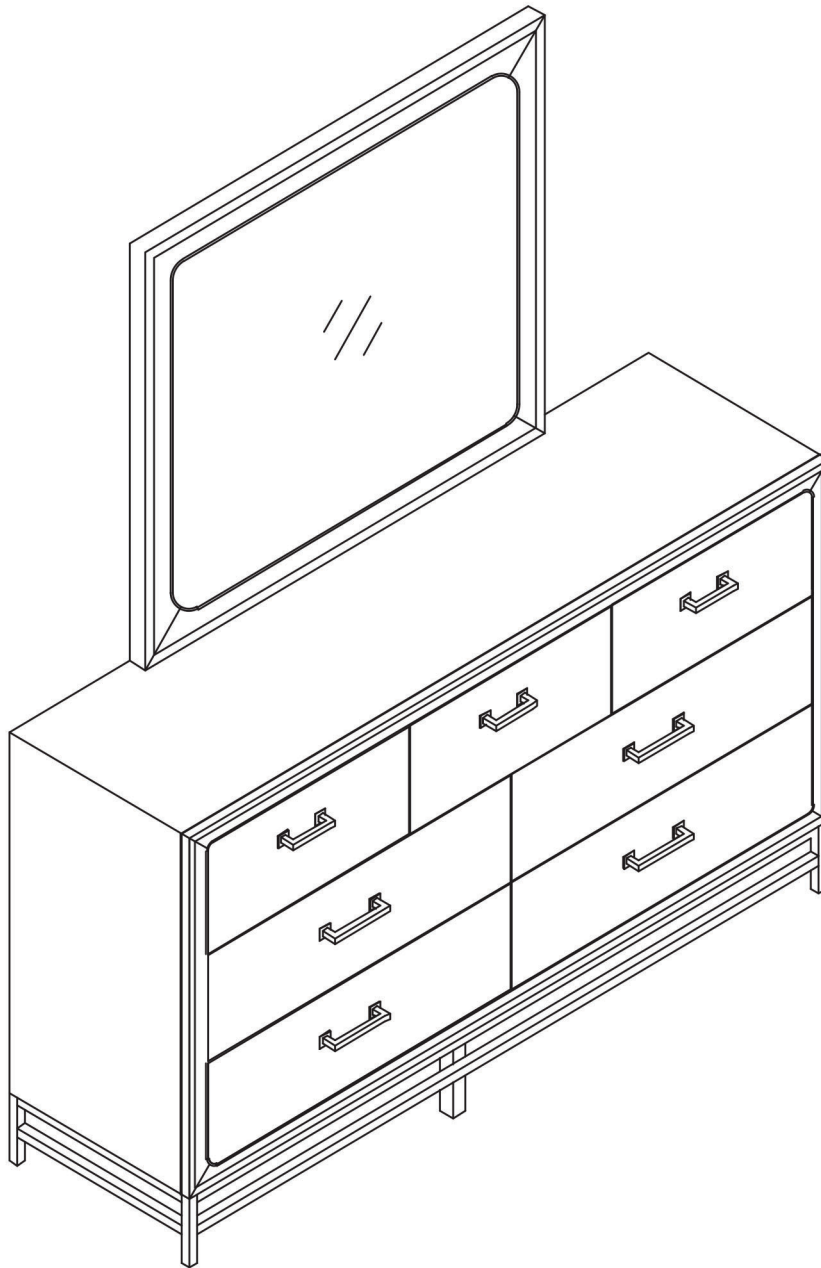

## TOOLS REQUIRED



Allen Key  
(Included)



2 People

## ASSEMBLY RATING

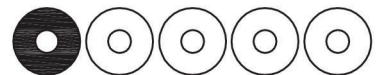

EASY —————> DIFFICULT

The Assembly Rating is a 5-point system showing the level of effort needed to assemble a specific product.



Thank you for your purchase!

We hope you enjoy this new addition to your home for many years to come.

Our commitment to providing quality products does not simply end when you purchase our product. We fully stand behind our products from start to finish. Our customer service department is available Monday – Friday 8:30 AM – 5:30 PM Pacific Time and can help with assembly questions as well as, if necessary, replacing damaged or missing parts. To help expedite our service, please have these assembly instructions readily available, along with your order receipt.



**Consumer Hotline**  
Toll-Free 1-888-980-5122



**Monday to Friday**  
8:30AM- 5:30PM (PT)



**WEBSITE**  
[www.foagroup.com](http://www.foagroup.com)



**E-MAIL**  
[cs.ec@foagroup.com](mailto:cs.ec@foagroup.com)



foagroup



FurnitureOfAmerica



## CHECK BEFORE STARTING

### Are you missing anything?

Double-check all parts, hardware and accessories listed are all accounted for.

### Check out our Quick Tips!

We recommend reviewing the pre-assembly handouts. Even experts need a refresher now and then!

### Should we send any replacements?

Are there any irregularities or flaws in the parts? We can send replacements!

### Prep Time!

Please review the assembly instructions and all diagrams prior to assembling.

# PRE ASSEMBLY INTRODUCTION

We understand building ready-to-assemble furniture can be a challenging experience for some. To help avoid confusion, we have provided some helpful tips that may speed up the process.

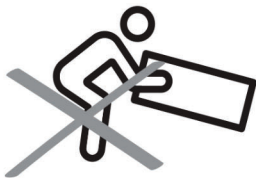

## Teamwork

ALWAYS have at least two people to help with transporting and assembling the product to avoid potential injury and/or damage.

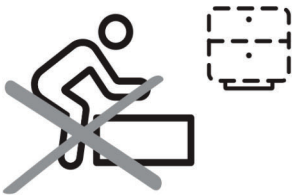

## Suitable Location

Assembling near the area of the intended location is highly recommended.



## Sufficient Space

Make sure you have enough space to move around during the assembly.



## Avoid Scratches

Use cardboard, blankets or a carpeted area while assembling furniture to prevent to prevent scratches and damages.



## Flat Surface

Make sure the furniture rests on a flat and level surface with each leg evenly touching the floor.

# ASSEMBLY AND CARE ADVICE



**FAILURE TO FOLLOW THE GUIDELINES BELOW MAY RESULT IN INJURY AND/OR PROPERTY DAMAGE.**



Position each part correctly and insert screws or bolts into their respective holes.

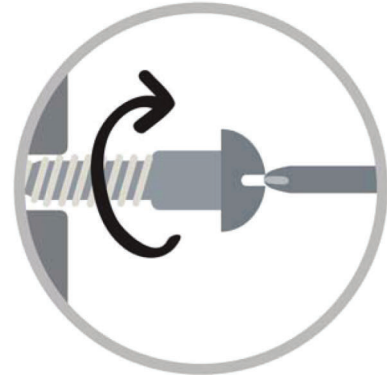

Turn clockwise to tighten and only tighten when step is completed or when instructed to do so.



Use the appropriate hand tools or power tools for assembly. Select steps, such as tightening screws and/or bolts, may require hand tools to avoid causing damage during assembly.



Save the instructions and store any supplied tools for later maintenance.



After two weeks, check and tighten any loose hardware and repeat again every six months thereafter.

**IT IS THE USER'S RESPONSIBILITY TO MAINTAIN THE FURNITURE. THE HARDWARE MAY LOOSEN OVER TIME AND MAY CAUSE THE FURNITURE TO BE WOBBLY AND UNABLE TO SUPPORT ITS INTENDED WEIGHT CAPACITY. THIS MAY LEAD TO COLLAPSE AND MAY CAUSE SERIOUS INJURY.**

# DRESSER

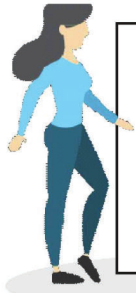

- Please keep instructions for future reference.
- Check the quantity and irregularity of parts and hardware before you start.

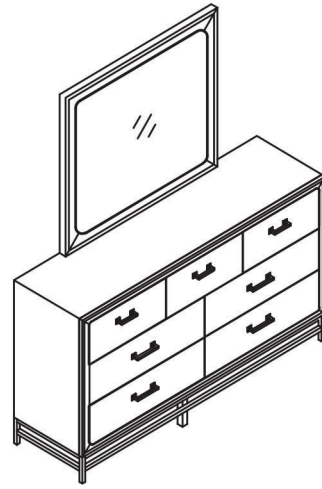

## PARTS

Ⓐ

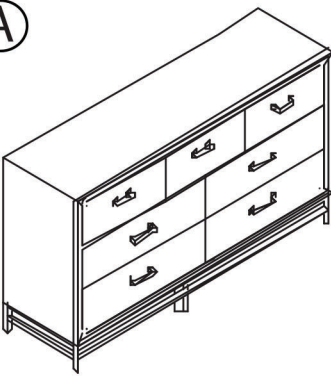

DRESSER  
1 pc.

Ⓑ

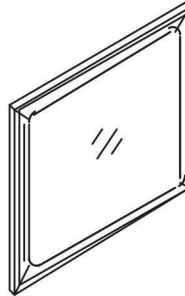

MIRROR  
1 pc.

Ⓒ

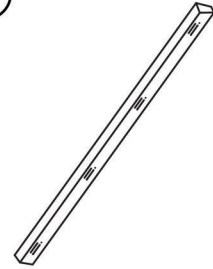

SUPPORT SLATS  
2 pcs.

## HARDWARE

①

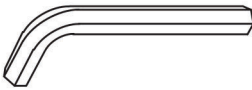

ALLEN KEY M4\*58MM  
1 pc.

②



FLAT HEAD BOLT  
Ø1/4"\*1-1/2"  
8 pc.

③

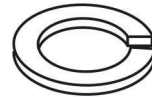

SPRING WASHER  
Ø1/4"\*12\*2MM  
8 pc.

④



FLAT WASHER  
Ø1/4"\*19\*2MM  
8 pc.

⑤

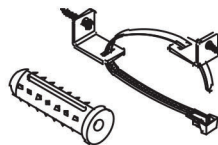

ANTI-TIP KIT  
1 set

# ASSEMBLY INSTRUCTIONS

1

#2x 8pcs

#3x 8pcs

#4x 8pcs

I. Secure Lower end of the Support Slats (#C) to the dresser (#A) by using Bolt (#2) with Spring washer (#3) and Flat washer (#4). Align the Mirror (#B) to the Upper end of the Support Slats (#C) and secure by using Bolt (#2) with Spring washer (#3) and Flat washer (#4).

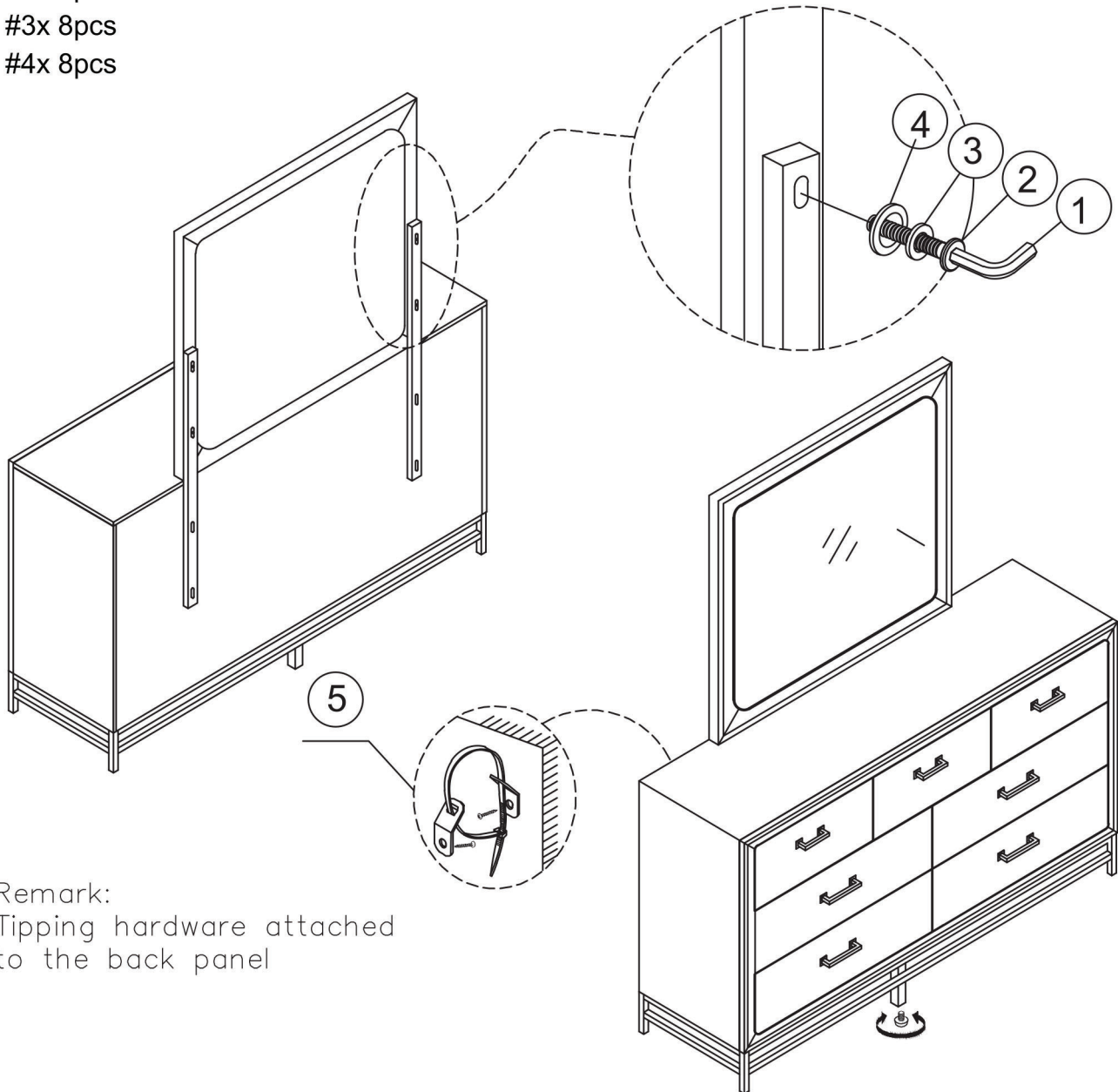

Remark:  
Tipping hardware attached  
to the back panel

II. Use Anti-tip kit (#5) to attach the top  
of the dresser (#A) to the wall.

III. Move adjuster on the center support  
leg to level the leg to the floor.

# ASSEMBLY INSTRUCTIONS

2

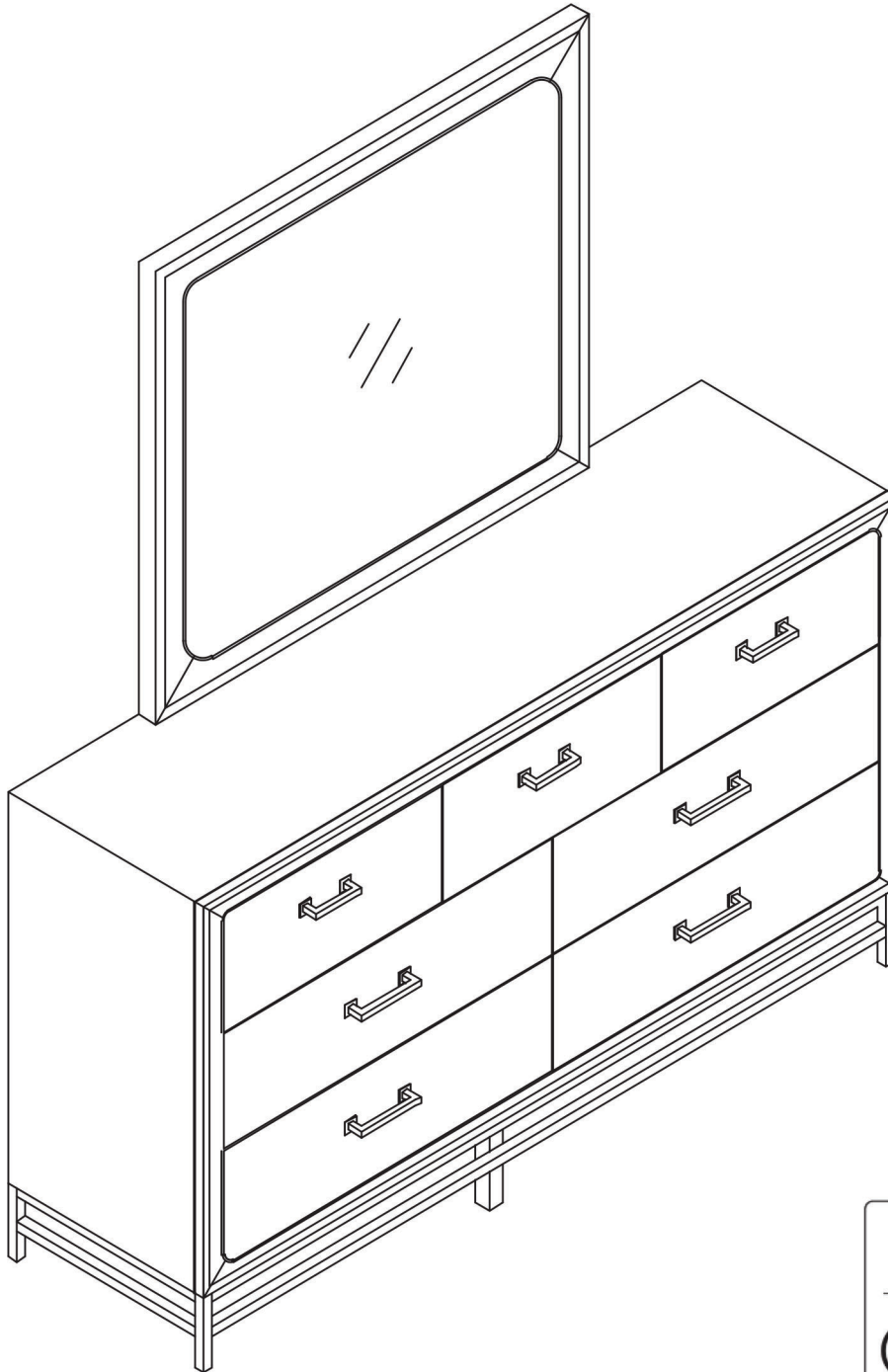

## ASSEMBLY COMPLETED



Please ensure the furniture rests on an even and flat surface. If the product wobbles or feels loose, double-check all bolts and/or screws are properly tightened and secured.



### Keep this handy!

Please retain this instruction manual and any order-related information for future reference.



### Lift, don't drag!

To avoid damage to product please always LIFT the product when transporting or adjusting the placement.

# ASSEMBLY INSTRUCTIONS

## Wall Mounting and Fixing



### EXPANSION WALL ANCHOR

Our provided expansion wall anchors are only suitable for masonry walls, such as drywall, plaster or concrete, and are best for holding lightweight items or for anti-tip prevention. If you are unsure of the correct wall anchor to use with the product, please request professional guidance. Liability for product damage or failure due to using the incorrect anchors will fall on the installer.

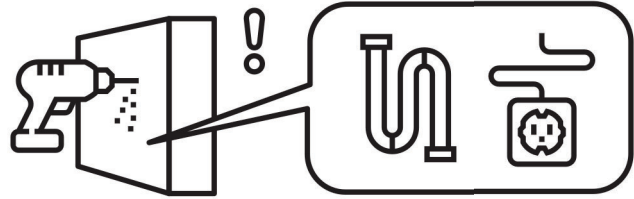

### CHECK BEFORE PROCEEDING

Prior to drilling or hammering, please check for wires or pipes. We recommend using a stud finder to locate a stud, which will offer more appropriate resistance and hold more weight.

## QUICK TIPS

1. If unsure of the proper size, always choose a larger screw and wall anchor.

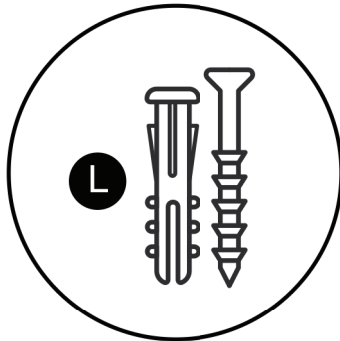

2. Match the drill bit to the wall anchor and hole size.

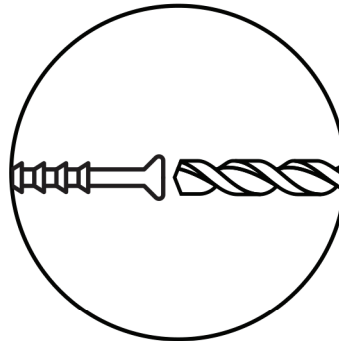

3. Only drill horizontally. Do not force the drill or enlarge the hole for the wall anchor.

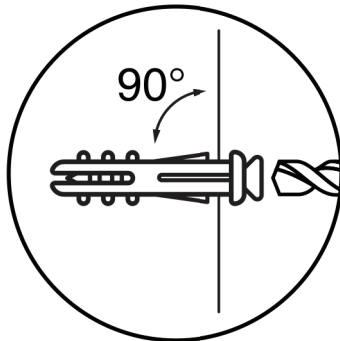

4. Take extra care when drilling into high walls or ceramic tiles. Wall anchors should be a tight fit for the hole. Never use wall anchors in ceilings.

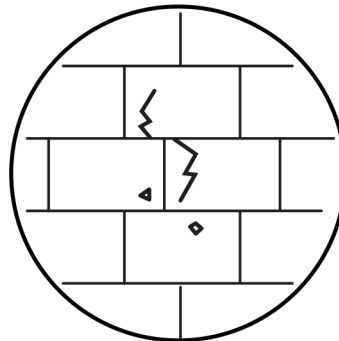

### MAINTENANCE



Yearly  
Check

We recommend a yearly check to see if the wall anchor or screw has loosened. If so, please remove the existing wall anchor and screw, and use a new anchor.

# ASSEMBLY INSTRUCTIONS

MODEL #

**FM7369AK-N**

Questions?

GIVE US A CALL: 1-888-980-5122  
MON-FRI 8:30AM - 5:30PM (PT)

## TOOLS REQUIRED

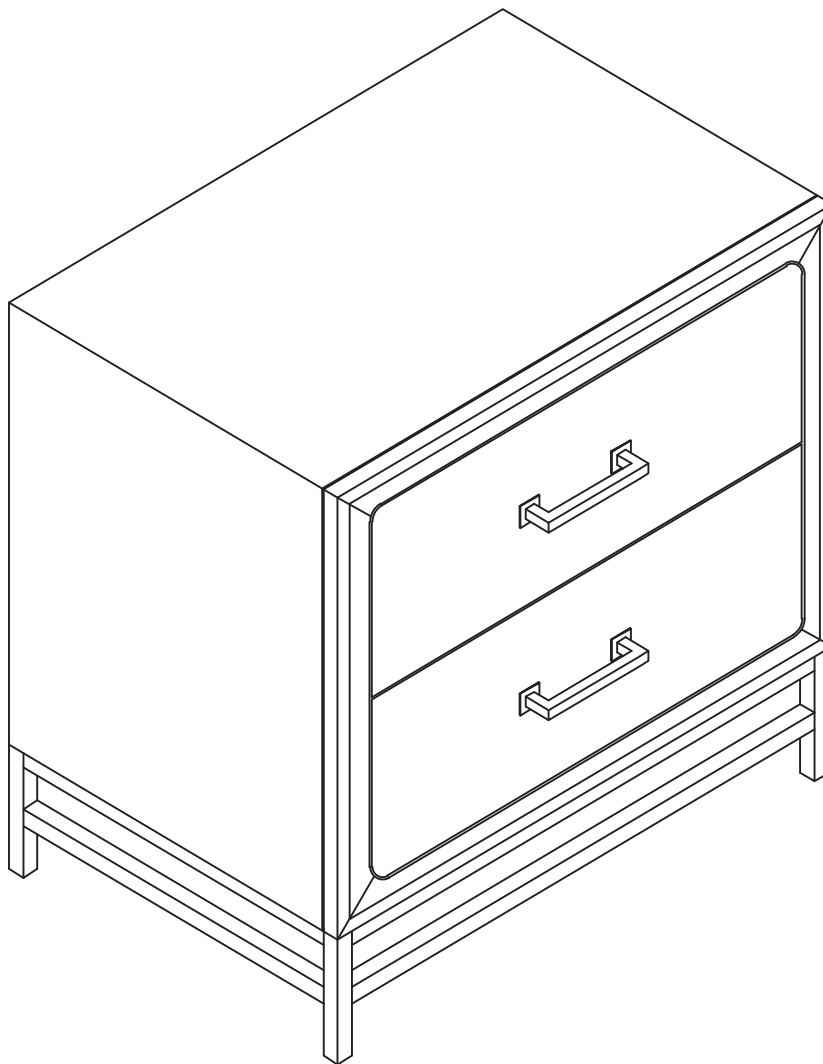

2 - People

## ASSEMBLY RATING



EASY → DIFFICULT

The Assembly Rating is a 5-point system showing the level of effort needed to assemble a specific product.



Thank you for your purchase!

We hope you enjoy this new addition to your home for many years to come.

Our commitment to providing quality products does not simply end when you purchase our product. We fully stand behind our products from start to finish. Our customer service department is available Monday – Friday 8:30 AM – 5:30 PM Pacific Time and can help with assembly questions as well as, if necessary, replacing damaged or missing parts. To help expedite our service, please have these assembly instructions readily available, along with your order receipt.



**Consumer Hotline**  
Toll-Free 1-888-980-5122



**Monday to Friday**  
8:30AM- 5:30PM (PT)



**WEBSITE**  
[www.foagroup.com](http://www.foagroup.com)



**E-MAIL**  
[cs.ec@foagroup.com](mailto:cs.ec@foagroup.com)



foagroup



FurnitureOfAmerica



## CHECK BEFORE STARTING

### Are you missing anything?

Double-check all parts, hardware and accessories listed are all accounted for.

### Check out our Quick Tips!

We recommend reviewing the pre-assembly handouts. Even experts need a refresher now and then!

### Should we send any replacements?

Are there any irregularities or flaws in the parts? We can send replacements!

### Prep Time!

Please review the assembly instructions and all diagrams prior to assembling.

# PRE ASSEMBLY INTRODUCTION

We understand building ready-to-assemble furniture can be a challenging experience for some. To help avoid confusion, we have provided some helpful tips that may speed up the process.

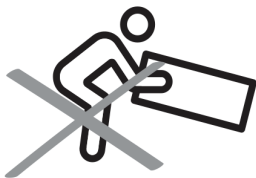

## Teamwork

ALWAYS have at least two people to help with transporting and assembling the product to avoid potential injury and/or damage.

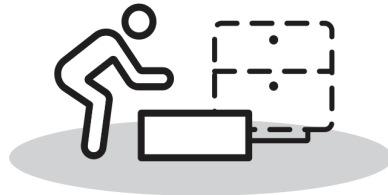
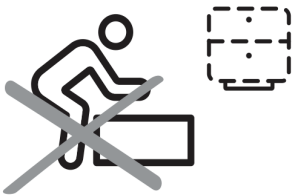

## Suitable Location

Assembling near the area of the intended location is highly recommended.



## Sufficient Space

Make sure you have enough space to move around during the assembly.



## Avoid Scratches

Use cardboard, blankets or a carpeted area while assembling furniture to prevent to prevent scratches and damages.



## Flat Surface

Make sure the furniture rests on a flat and level surface with each leg evenly touching the floor.

# ASSEMBLY AND CARE ADVICE



**FAILURE TO FOLLOW THE GUIDELINES BELOW MAY RESULT IN INJURY AND/OR PROPERTY DAMAGE.**



Position each part correctly and insert screws or bolts into their respective holes.

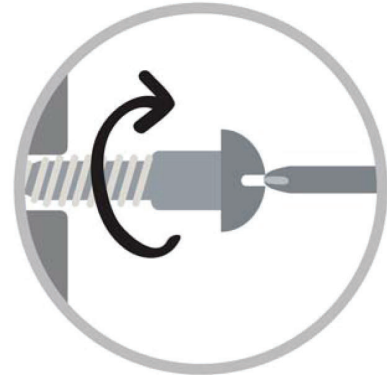

Turn clockwise to tighten and only tighten when step is completed or when instructed to do so.



Use the appropriate hand tools or power tools for assembly. Select steps, such as tightening screws and/or bolts, may require hand tools to avoid causing damage during assembly.



Save the instructions and store any supplied tools for later maintenance.



After two weeks, check and tighten any loose hardware and repeat again every six months thereafter.

**IT IS THE USER'S RESPONSIBILITY TO MAINTAIN THE FURNITURE. THE HARDWARE MAY LOOSEN OVER TIME AND MAY CAUSE THE FURNITURE TO BE WOBBLY AND UNABLE TO SUPPORT ITS INTENDED WEIGHT CAPACITY. THIS MAY LEAD TO COLLAPSE AND MAY CAUSE SERIOUS INJURY.**

# NIGHTSTAND

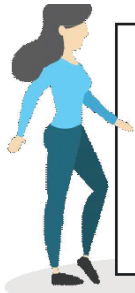

- Please keep instructions for future reference.
- Check the quantity and irregularity of parts and hardware before you start.

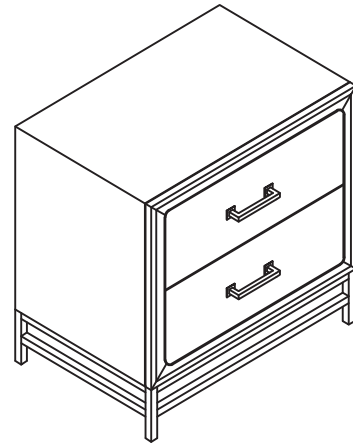

## PARTS

A

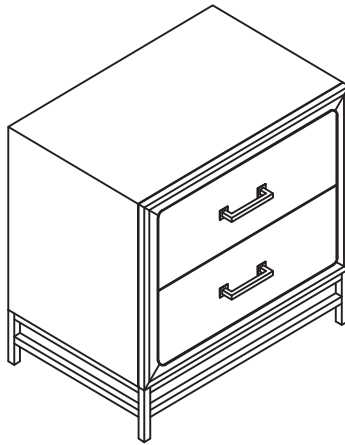

NIGHTSTAND  
1 pc.

# ASSEMBLY INSTRUCTIONS

1

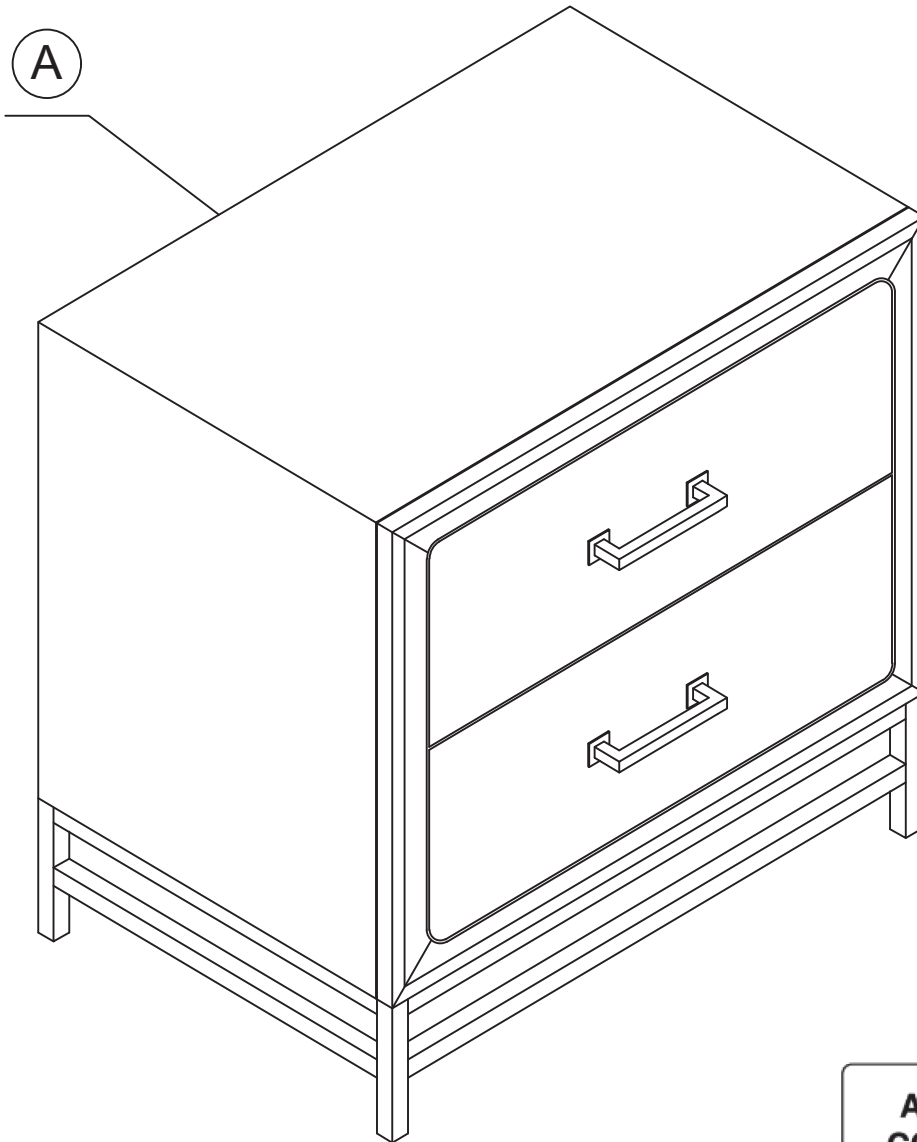

## ASSEMBLY COMPLETED



Please ensure the furniture rests on an even and flat surface. If the product wobbles or feels loose, double-check all bolts and/or screws are properly tightened and secured.

### ✓ Keep this handy!

Please retain this instruction manual and any order-related information for future reference.

### ✓ Lift, don't drag!

To avoid damage to product please always LIFT the product when transporting or adjusting the placement.

# ASSEMBLY INSTRUCTIONS

MODEL #

**FM7369-Q-P-BED**

Questions?

GIVE US A CALL: 1-888-980-5122  
MON-FRI 8:30AM - 5:30PM (PT)

## TOOLS REQUIRED

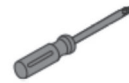
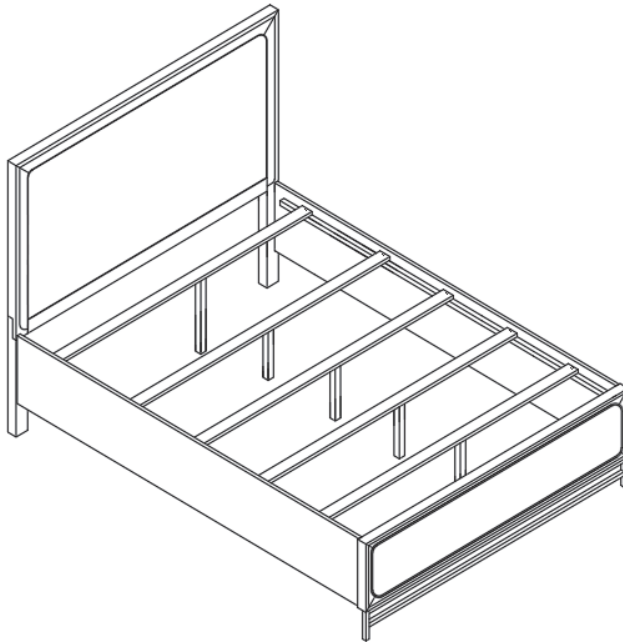

Screwdriver  
( Not included)

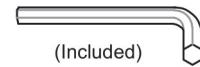

(Included)  
Allen Wrench



2 - People

## ASSEMBLY RATING



EASY → DIFFICULT

The Assembly Rating is a 5-point system showing the level of effort needed to assemble a specific product.



Thank you for your purchase!

We hope you enjoy this new addition to your home for many years to come.

Our commitment to providing quality products does not simply end when you purchase our product. We fully stand behind our products from start to finish. Our customer service department is available Monday – Friday 8:30 AM – 5:30 PM Pacific Time and can help with assembly questions as well as, if necessary, replacing damaged or missing parts. To help expedite our service, please have these assembly instructions readily available, along with your order receipt.



**Consumer Hotline**  
Toll-Free 1-888-980-5122



**Monday to Friday**  
8:30AM- 5:30PM (PT)



**WEBSITE**  
[www.foagroup.com](http://www.foagroup.com)



**E-MAIL**  
[cs.ec@foagroup.com](mailto:cs.ec@foagroup.com)



foagroup



FurnitureOfAmerica



## CHECK BEFORE STARTING

### Are you missing anything?

Double-check all parts, hardware and accessories listed are all accounted for.

### Check out our Quick Tips!

We recommend reviewing the pre-assembly handouts. Even experts need a refresher now and then!

### Should we send any replacements?

Are there any irregularities or flaws in the parts? We can send replacements!

### Prep Time!

Please review the assembly instructions and all diagrams prior to assembling.

# PRE ASSEMBLY INTRODUCTION

We understand building ready-to-assemble furniture can be a challenging experience for some. To help avoid confusion, we have provided some helpful tips that may speed up the process.

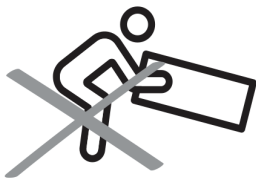

## Teamwork

ALWAYS have at least two people to help with transporting and assembling the product to avoid potential injury and/or damage.

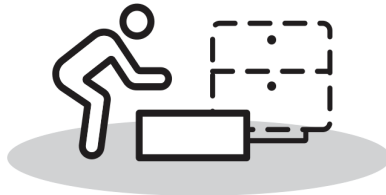
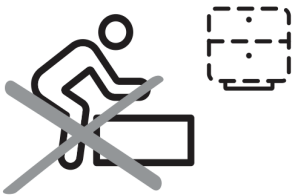

## Suitable Location

Assembling near the area of the intended location is highly recommended.



## Sufficient Space

Make sure you have enough space to move around during the assembly.



## Avoid Scratches

Use cardboard, blankets or a carpeted area while assembling furniture to prevent to prevent scratches and damages.



## Flat Surface

Make sure the furniture rests on a flat and level surface with each leg evenly touching the floor.

# ASSEMBLY AND CARE ADVICE



**FAILURE TO FOLLOW THE GUIDELINES BELOW MAY RESULT IN INJURY AND/OR PROPERTY DAMAGE.**



Position each part correctly and insert screws or bolts into their respective holes.

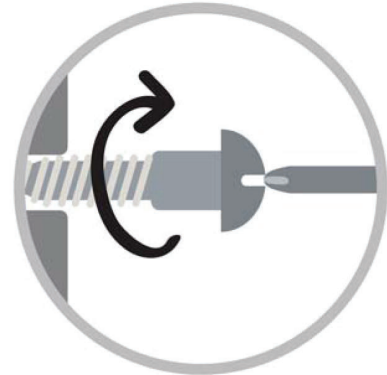

Turn clockwise to tighten and only tighten when step is completed or when instructed to do so.



Use the appropriate hand tools or power tools for assembly. Select steps, such as tightening screws and/or bolts, may require hand tools to avoid causing damage during assembly.



Save the instructions and store any supplied tools for later maintenance.



After two weeks, check and tighten any loose hardware and repeat again every six months thereafter.

**IT IS THE USER'S RESPONSIBILITY TO MAINTAIN THE FURNITURE. THE HARDWARE MAY LOOSEN OVER TIME AND MAY CAUSE THE FURNITURE TO BE WOBBLY AND UNABLE TO SUPPORT ITS INTENDED WEIGHT CAPACITY. THIS MAY LEAD TO COLLAPSE AND MAY CAUSE SERIOUS INJURY.**

# BED

## FM 7369-Q-P-BED

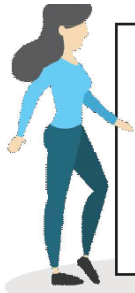

- Please keep instructions for future reference.
- Check the quantity and irregularity of parts and hardware before you start.

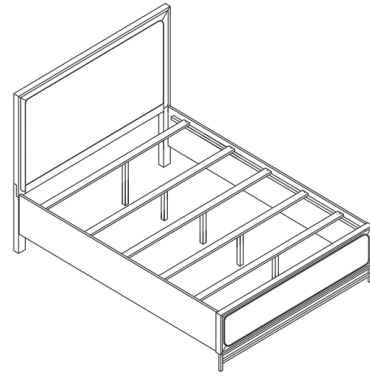

### PARTS

1

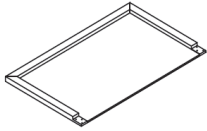

HEADBOARD 1 pc.

2

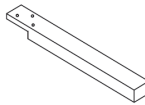

FOOT (LEFT) 1 pc.

3

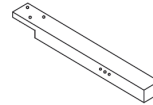

FOOT (RIGHT) 1 pc.

4



STRETCHER 1 pc.

5

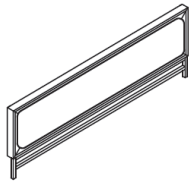

FOOTBOARD 1 pc.

6



SIDE RAIL 2PCS

7



SLATS 5PCS

8

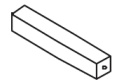

SUPPORT LEGS  
5PCS

## HARDWARE

A



BOLT  $\text{Ø}5/16'' \times 1\ 1/2''$   
8 pcs

B



SPRING WASHER  
 $\text{Ø}5/16'' \times 12 \times 2\text{MM}$   
8 pcs.

C



FLAT WASHER  
 $\text{Ø}5/16'' \times 19 \times 2\text{MM}$   
8 pcs.

D













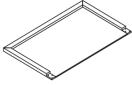

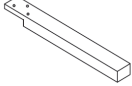
ALLEN  
WRENCH 1 pc.

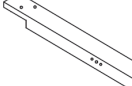
E



SCREW  $\text{Ø}4 \times 1\ 1/4''$   
10 pcs.

# FM7369-Q-P-BED is packed in 3 cases

carton	Disignation	part		Hardware
FM7369-Q-HB-P-1	Headboard	①		 A 8 pcs
	Left HB Foot	②		 B 8 pcs
	Right HB Foot	③		 C 8 pcs
	Stretcher	④		 D 1 pc
FM7369-Q-FB-P-2	Footboard	⑤		 E 10 pcs
	Slats	⑦		
	Upper supprt legs	⑧		
FM7369-Q-R-3	Side Rail	⑥		

# ASSEMBLY INSTRUCTIONS

# 1

I. Align the Left/Right Foot (2,3) to Stretcher (4) and secure by using Bolt (A) with Spring washer (B) and Flat washer (C). II. Attach the Left/Right Foot (2, 3) to the Headboard (1) by using Bolt (A) with Spring washer (B) and Flat washer (C).

Part 1 x 1pc  
Part 2 x 1pc  
Part 3 x 1pc  
Part 4 x 1pc  
Hardware A x 8pcs  
Hardware B x 8pcs  
Hardware C x 8pcs

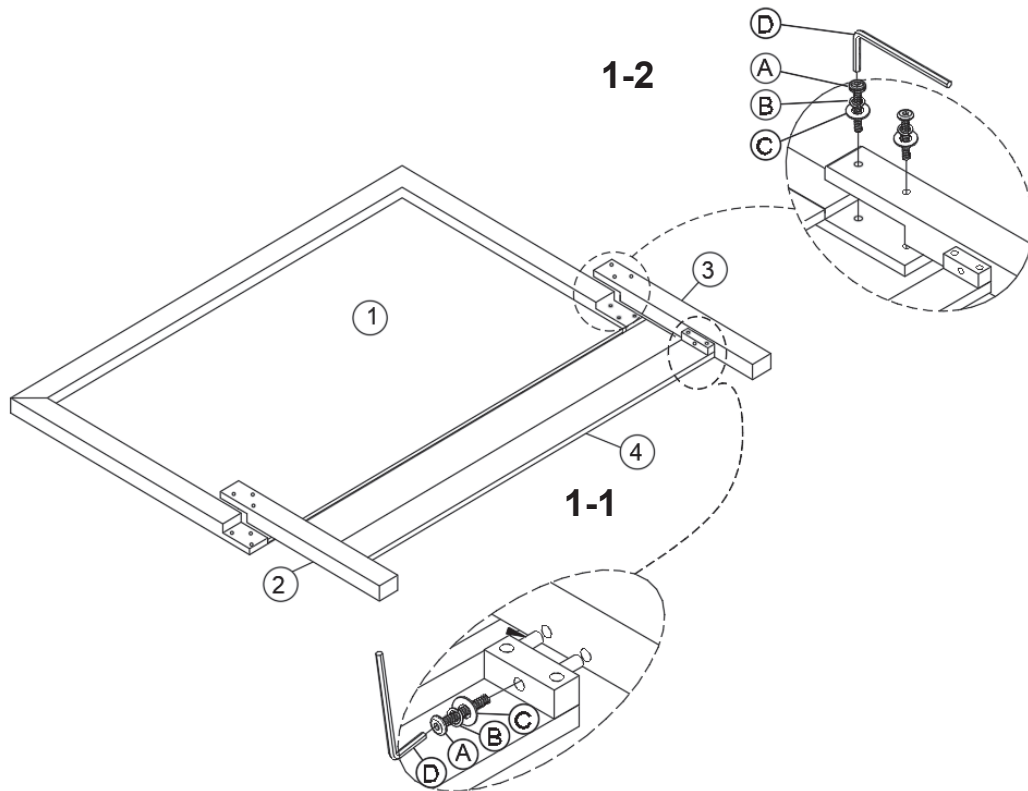

# ASSEMBLY INSTRUCTIONS

# 2

I. Hook the Side Rails (6) onto the Headboard (1) and the Footboard (5). Ensure rails are locked in.

Part 5 x 1pc  
Part 6 x 2pcs  
Part 7x 5pcs  
Part 8x 5pcs  
Hardware E x 10pcs

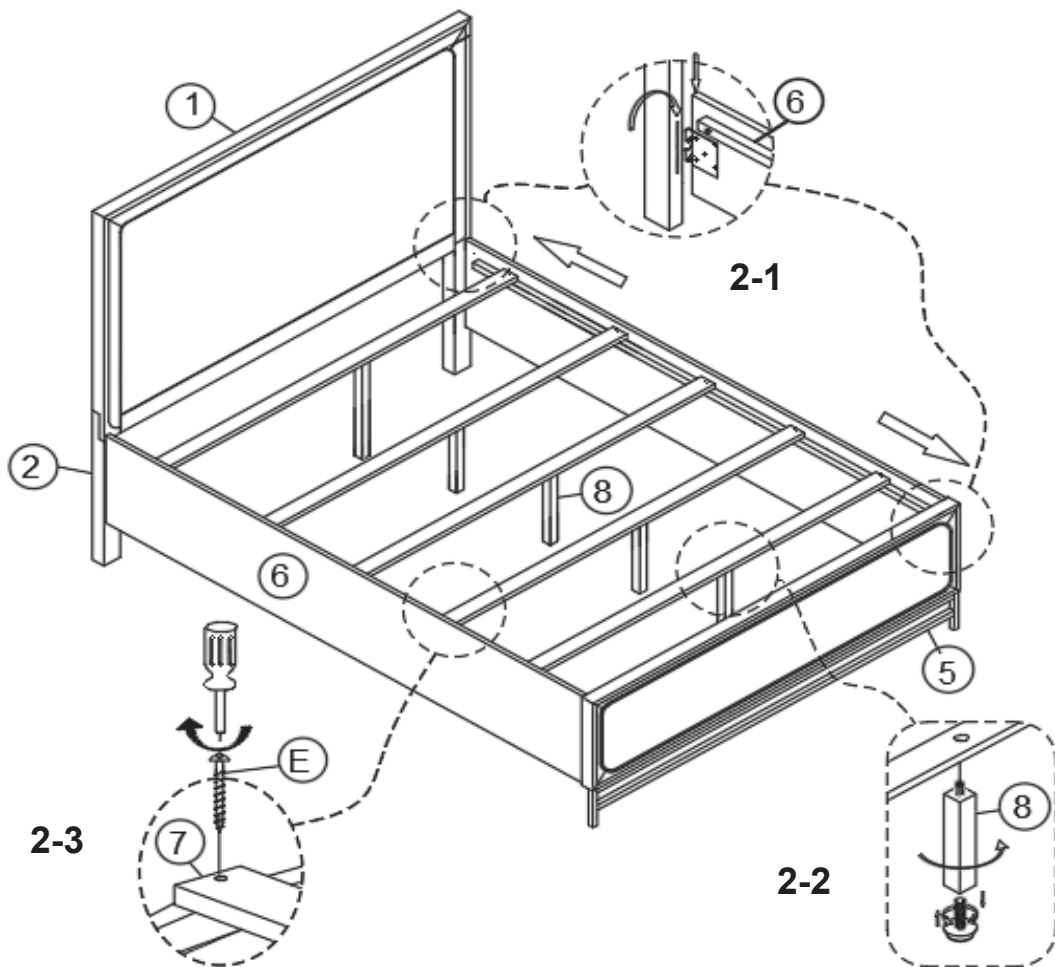

II. Attach the Upper support legs (8) to the Slats (7).

III. Evenly spread out the Slats (7) over the Side rails (6) and secure by using Screw (E).

# ASSEMBLY INSTRUCTIONS

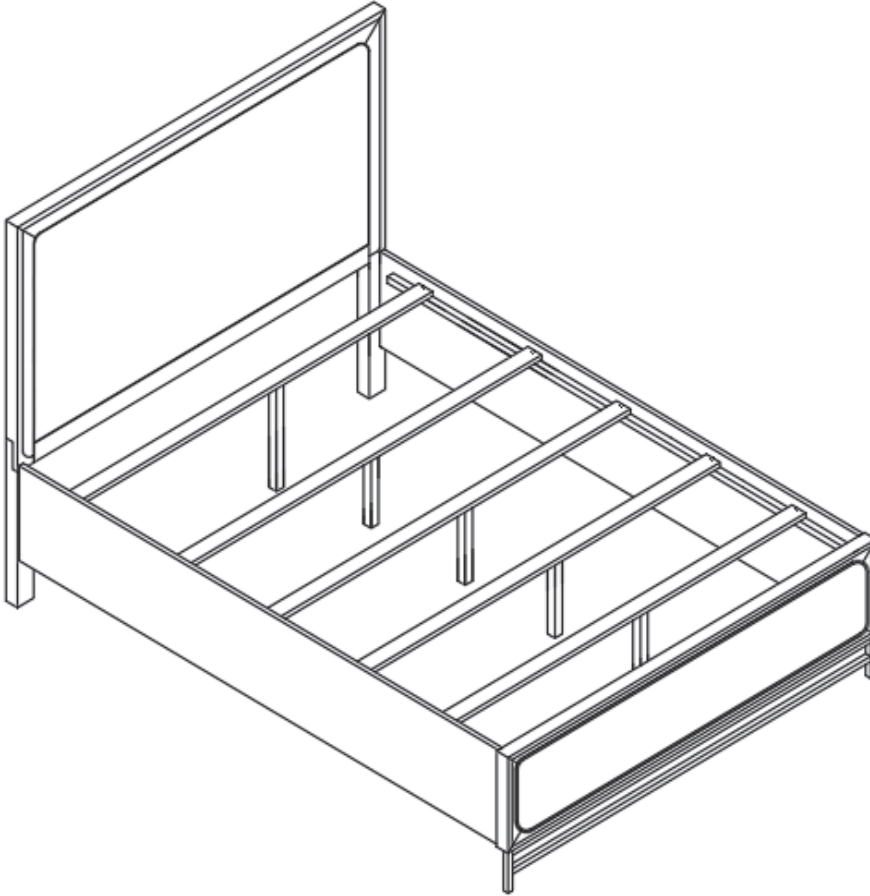

## ASSEMBLY COMPLETED



Please ensure the furniture rests on an even and flat surface. If the product wobbles or feels loose, double-check all bolts and/or screws are properly tightened and secured.



### Keep this handy!

Please retain this instruction manual and any order-related information for future reference.



### Lift, don't drag!

To avoid damage to product please always LIFT the product when transporting or adjusting the placement.

This product is intended for RESIDENTIAL USE ONLY and not for commercial use.