

ASSEMBLY INSTRUCTIONS

Component List :

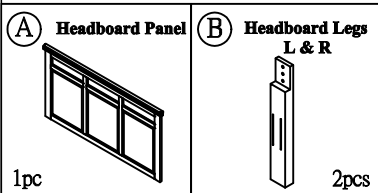

Hardware List :

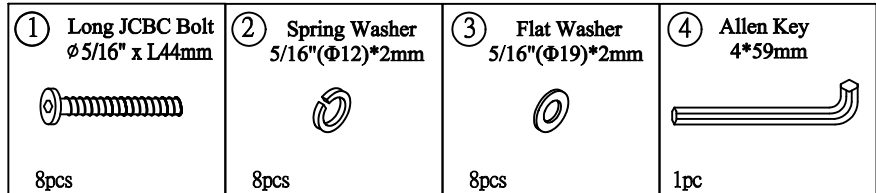

Caution: Please read instructions thoroughly before unpacking assembly parts. Sharp, exposed staple tips can cause injury, therefore, for your protection, please remove any exposed staples used in packing.

Please keep all hardware parts out of the reach of children.

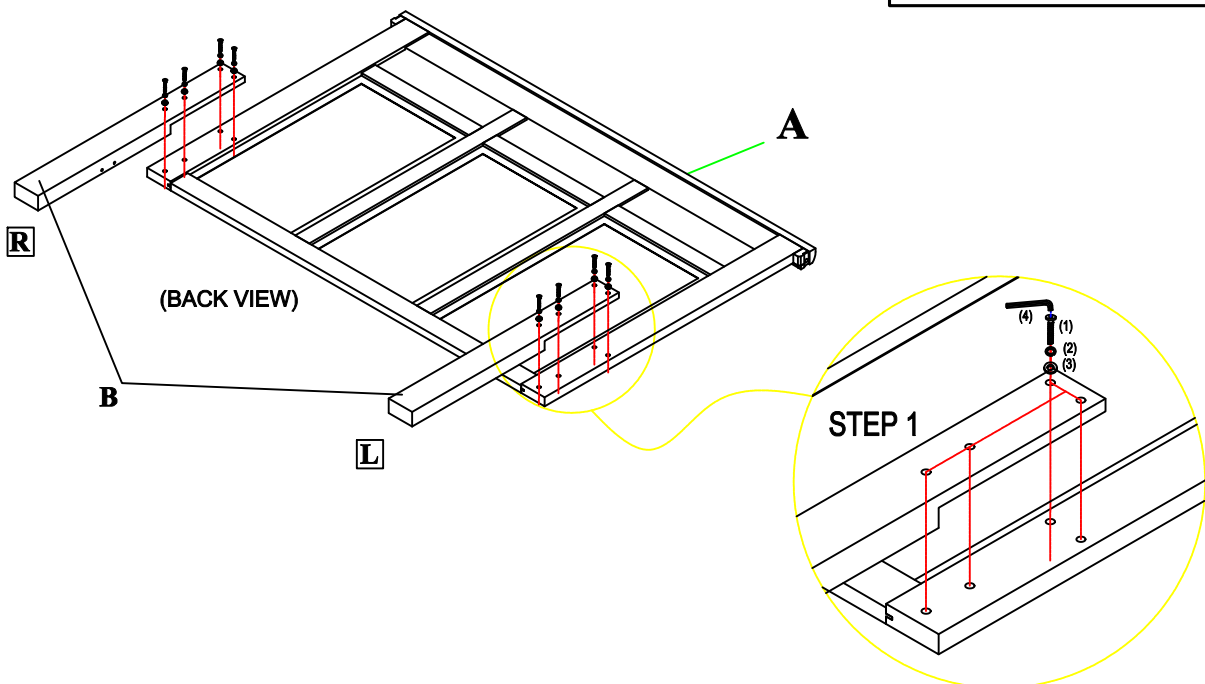
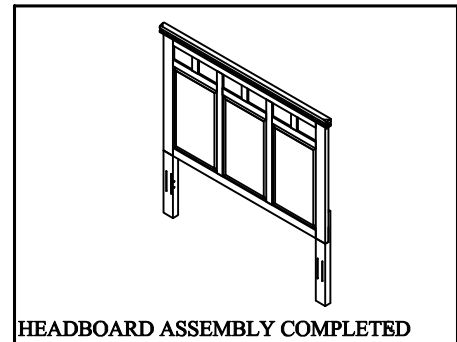

1. We recommend that you should assemble this product with the assistance of another person; this will make assembly easier, and will help to eliminate damage to the product or injury to persons during assembly.
2. Be sure to check all packing materials carefully for small parts that may have come loose inside the carton during shipment.
3. Please do not over tighten screws or bolts.
4. Please put all parts on a non-abrasive floor before assembly, and follow the assembly steps to assemble your newly purchased product correctly and efficiently.

Note : Bunkie board must be used to replace box spring



ASSEMBLY INSTRUCTIONS

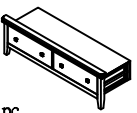
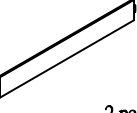
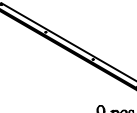
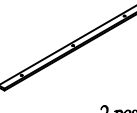

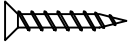

Component List KING :

(A) Headboard  1pc	(B) Footboard  1pc	(C) Side Rails  2 pcs	(D) Slats  9 pcs	(E) Slats Support Legs  2 pcs	(F) Slat Support Legs  6 pcs
---	--	---	--	---	--

Hardware List KING :

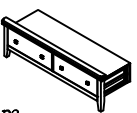
(1) Screw #8*25mm  44 pcs

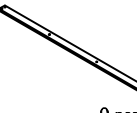
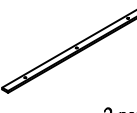
Component List CAL.KING:

(A) Headboard  1pc	(B) Footboard  1pc	(C) Side Rail Left  1pc	(D) Side Rail Right  1pc	(E) Slats  9 pcs	(F) Slats Support Legs  2 pcs	(G) Slat Support Legs  6 pcs
---	--	---	--	--	--	--

Hardware List CAL.KING :

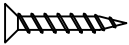
(1) Screw #8*25mm  44 pcs

Caution: Please read instructions thoroughly before unpacking assembly parts. Sharp, exposed staple tips can cause injury, therefore, for your protection, please remove any exposed staples used in packing.

Please keep all hardware parts out of the reach of children.

1. We recommend that you should assemble this product with the assistance of another person; this will make assembly easier, and will help to eliminate damage to the product or injury to persons during assembly.
2. Be sure to check all packing materials carefully for small parts that may have come loose inside the carton during shipment.
3. Please do not over tighten screws or bolts.
4. Please put all parts on a non-abrasive floor before assembly, and follow the assembly steps to assemble your newly purchased product correctly and efficiently.

