

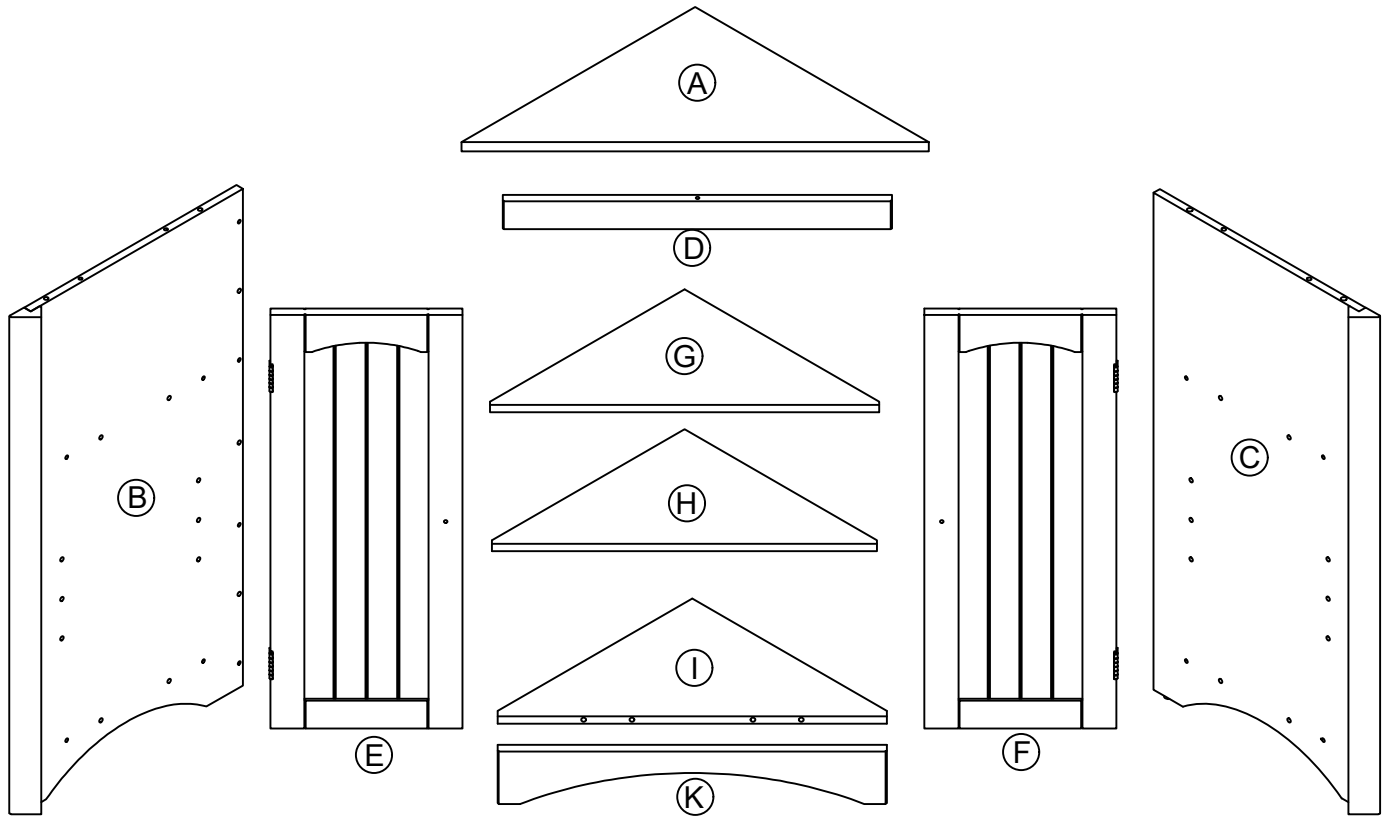

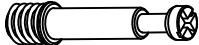







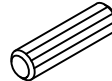

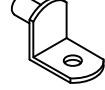
PACKAGE CONTENTS

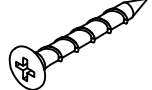

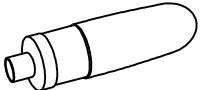
PART	DESCRIPTION	QTY		PART	DESCRIPTION	QTY
A	Top Panel	X1		F	Right Door	X1
B	Left Side Board	X1		G	Upper Shelf	X1
C	Right Side Board	X1		H	Shelf	X1
D	Front Bar	X1		I	Base Panel	X1
E	Left Door	X1		K	Base Panel Front Rail	X1

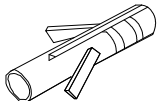
HARDWARE CONTENTS

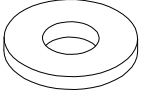

1	2	3	4
			
Ø6*33mm 18PCS	Ø15*9mm 18PCS	Ø6*30mm 21PCS	2PCS
5	6	7	8
			
5/32"*19mm 2PCS	4PCS	Ø3*10mm 4PCS	Ø4*38mm 4PCS
9	10	11	12
			
Ø3*12mm 8PCS	1PC	Ø4*20mm 1PC	1PC
13	14		
			
1PC	2PCS		

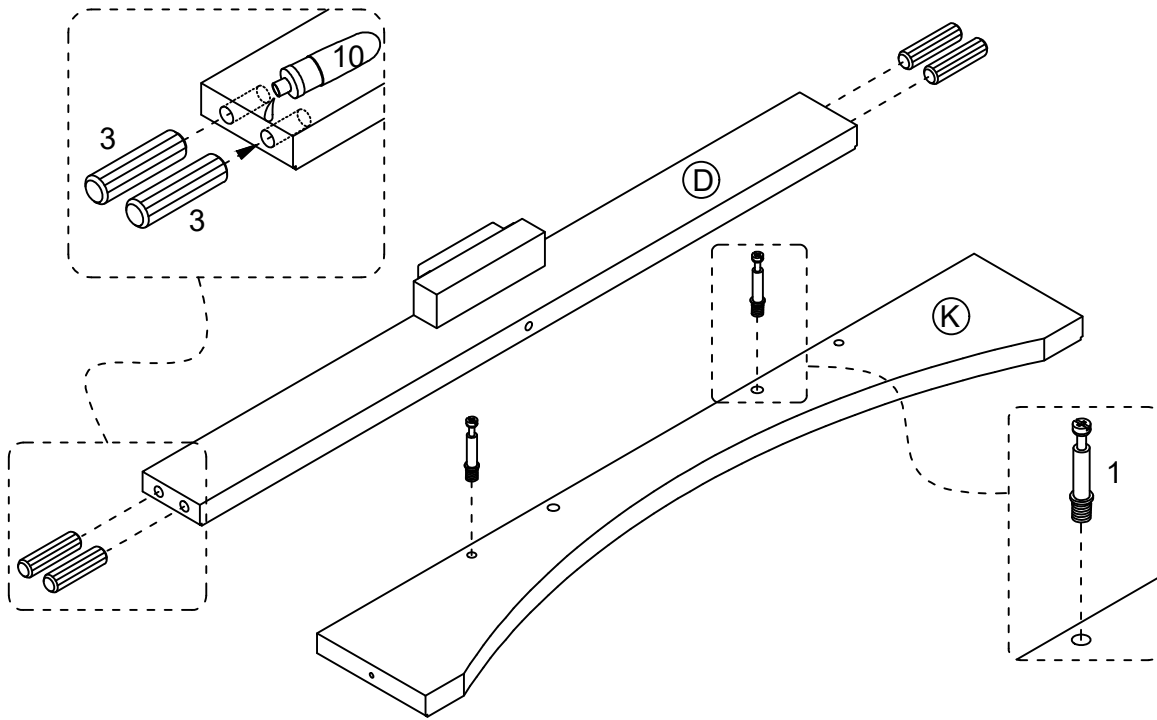
STEP1

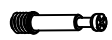

Glue the wood dowels 3 into the inner holes on the side panels D.

NOTE: It is very important to use a small amount of glue 10 on ends of dowels and wipe away excess glue immediately.

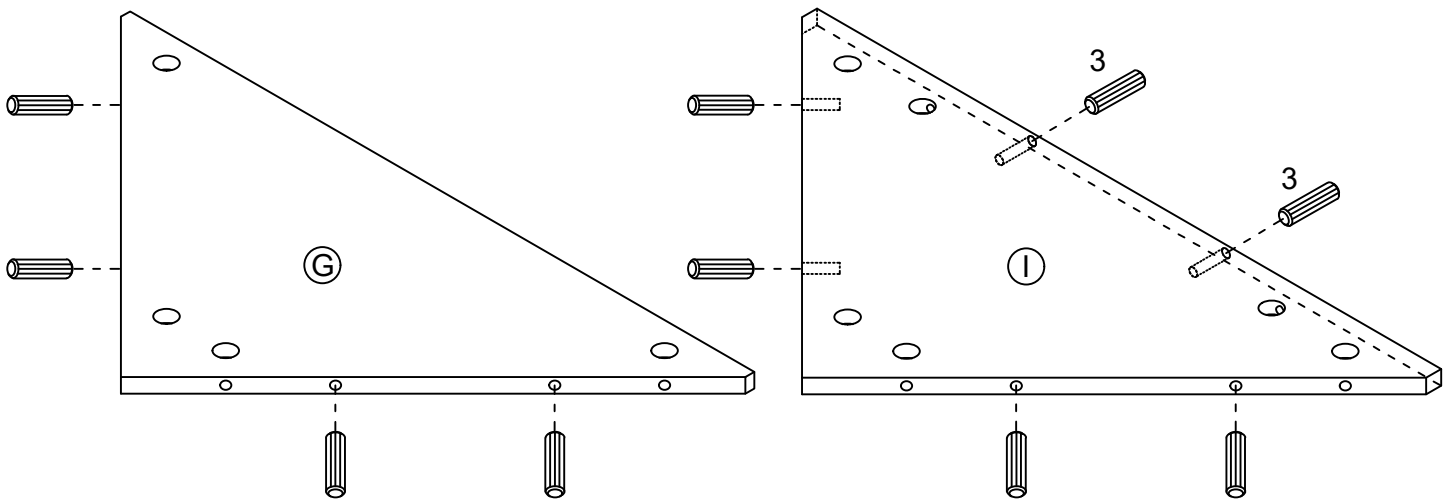
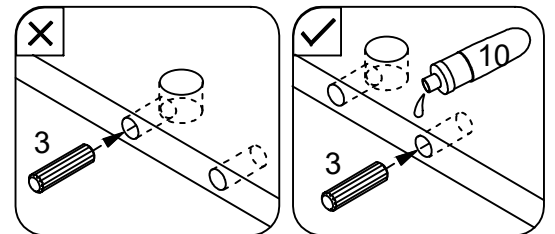

	1 x 2pcs
	3 x 4pcs
	10 x 1pc

STEP2





Glue the wood dowels 3 into the inner holes on the front upper rail G and I .

NOTE: It is very important to use a small amount of glue 10 on ends of dowels and wipe away excess glue immediately.

	3 x 10pcs
	10 x 1pc

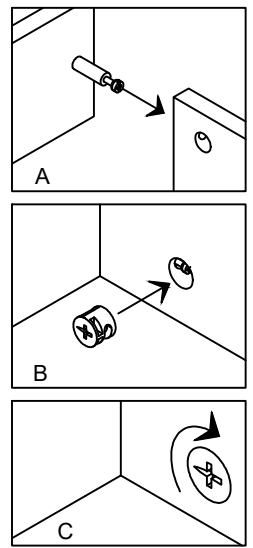
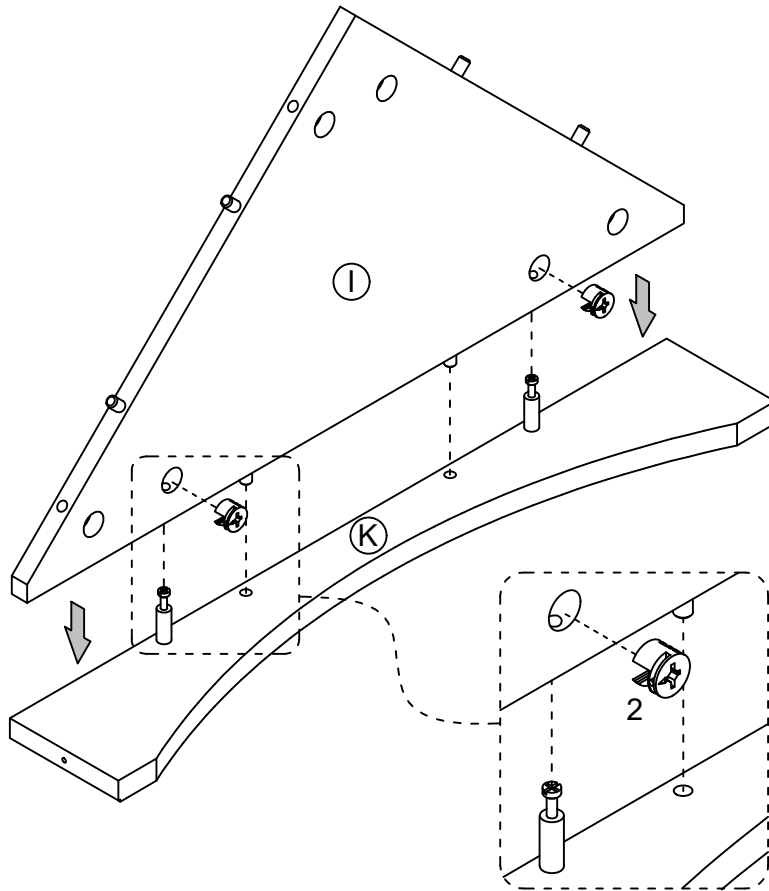
STEP3



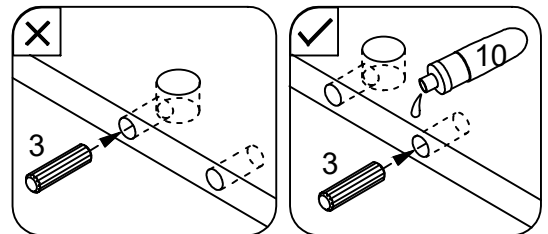
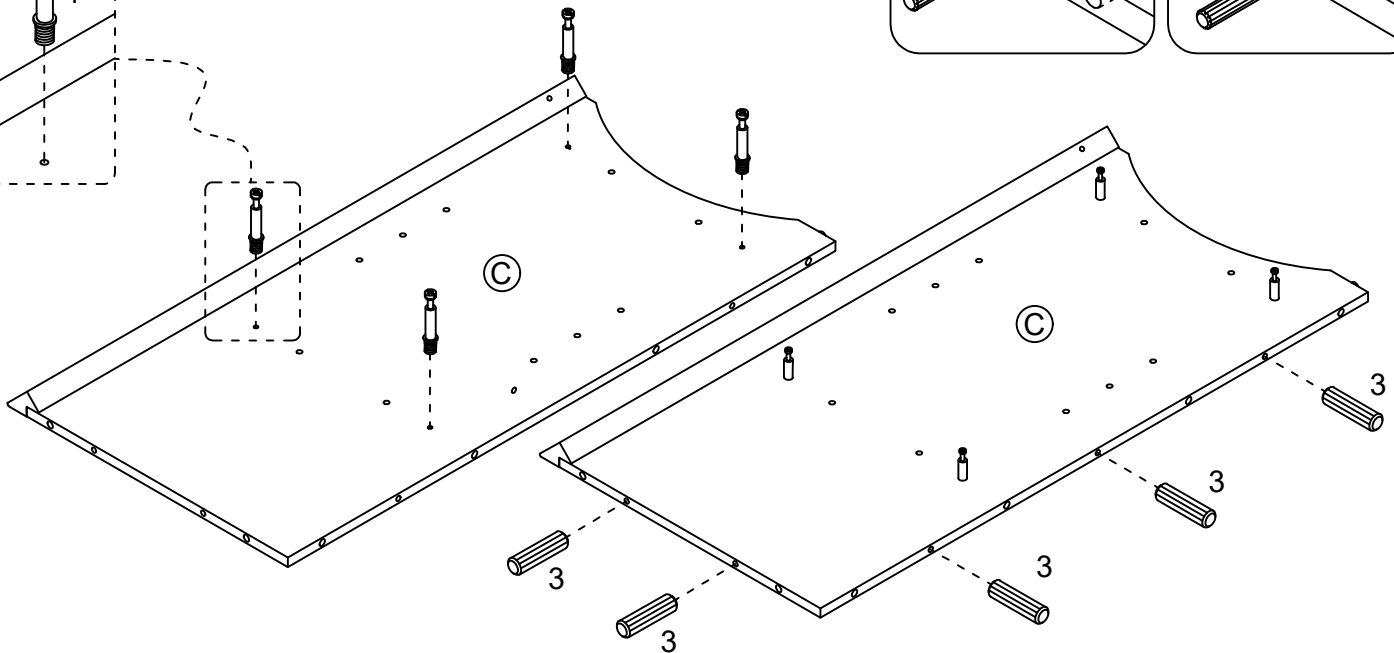
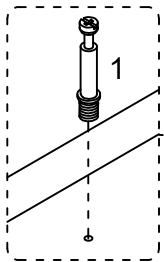

	2 x 2pcs
---	----------

STEP4



Glue the wood dowels 3 into the inner holes on the side panels C.
 NOTE: It is very important to use a small amount of glue 10 on ends of dowels and wipe away excess glue immediately.

	1 x 4pcs
	3 x 5pcs
	10 x 1pc

STEP5

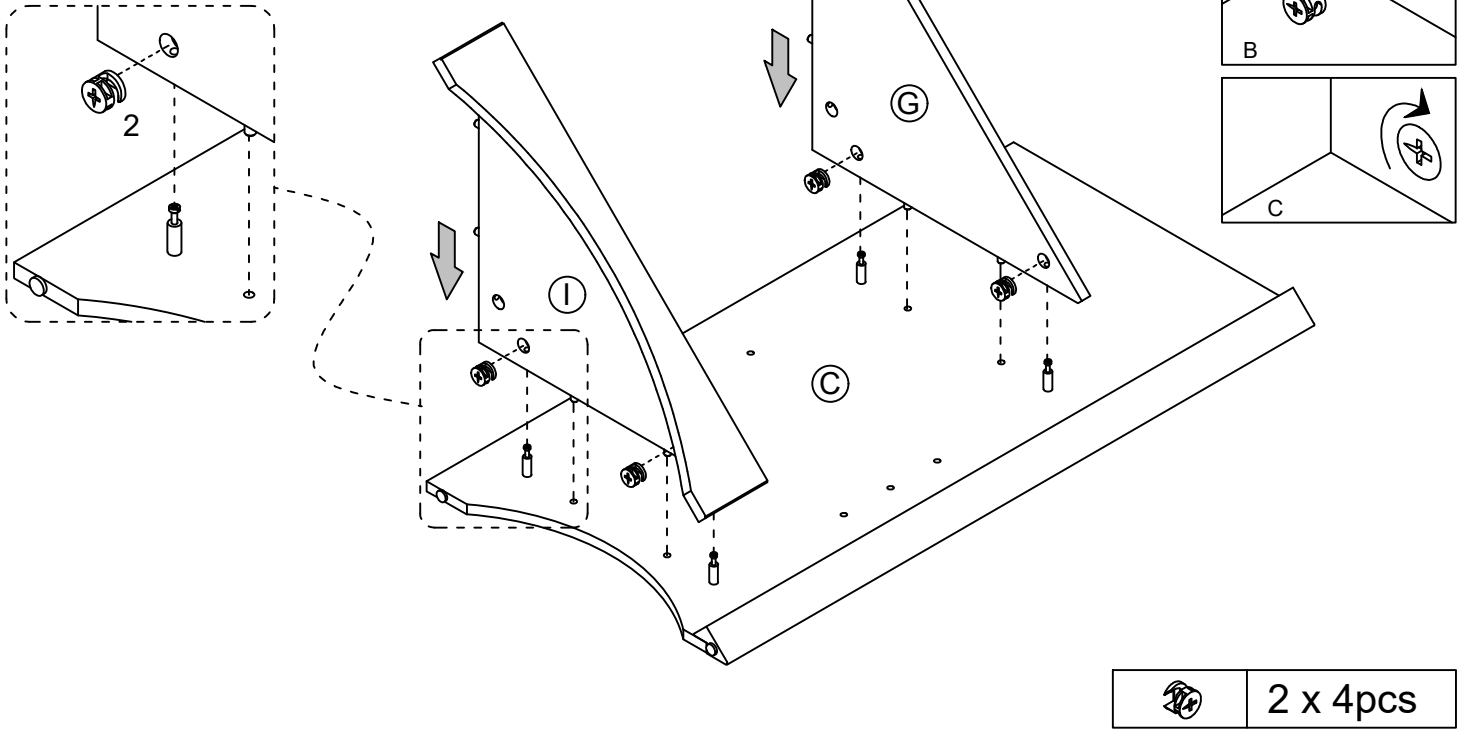

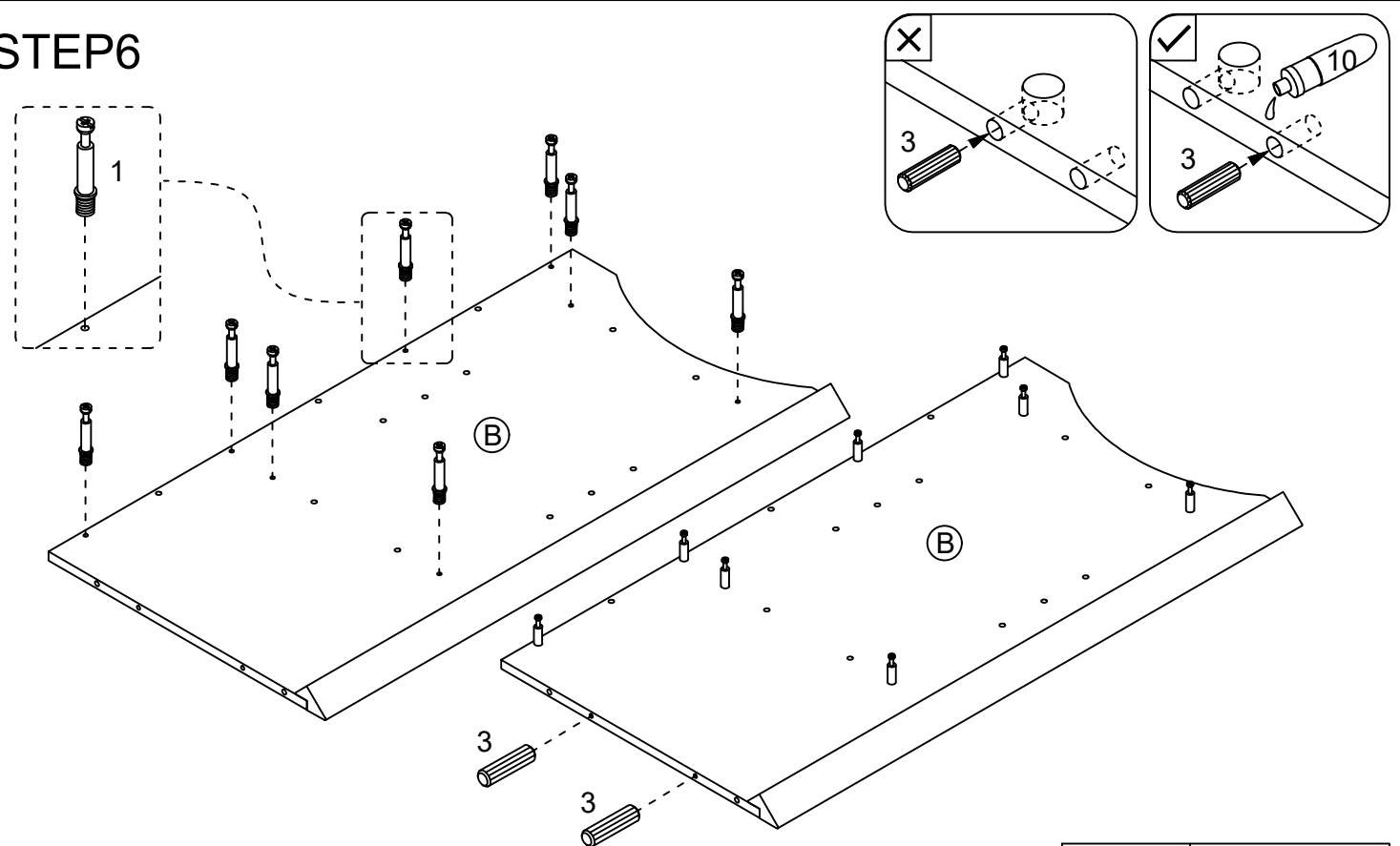

STEP6



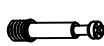

Glue the wood dowels 3 into the inner holes on the side panels B.

NOTE: It is very important to use a small amount of glue 10 on ends of dowels and wipe away excess glue immediately.

	1 x 8pcs
	3 x 2pcs
	10 x 1pc

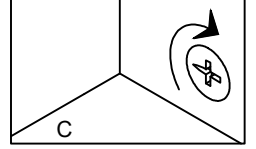
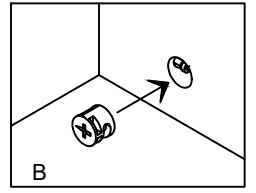
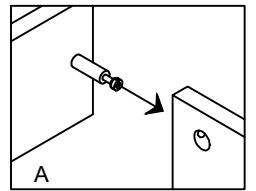
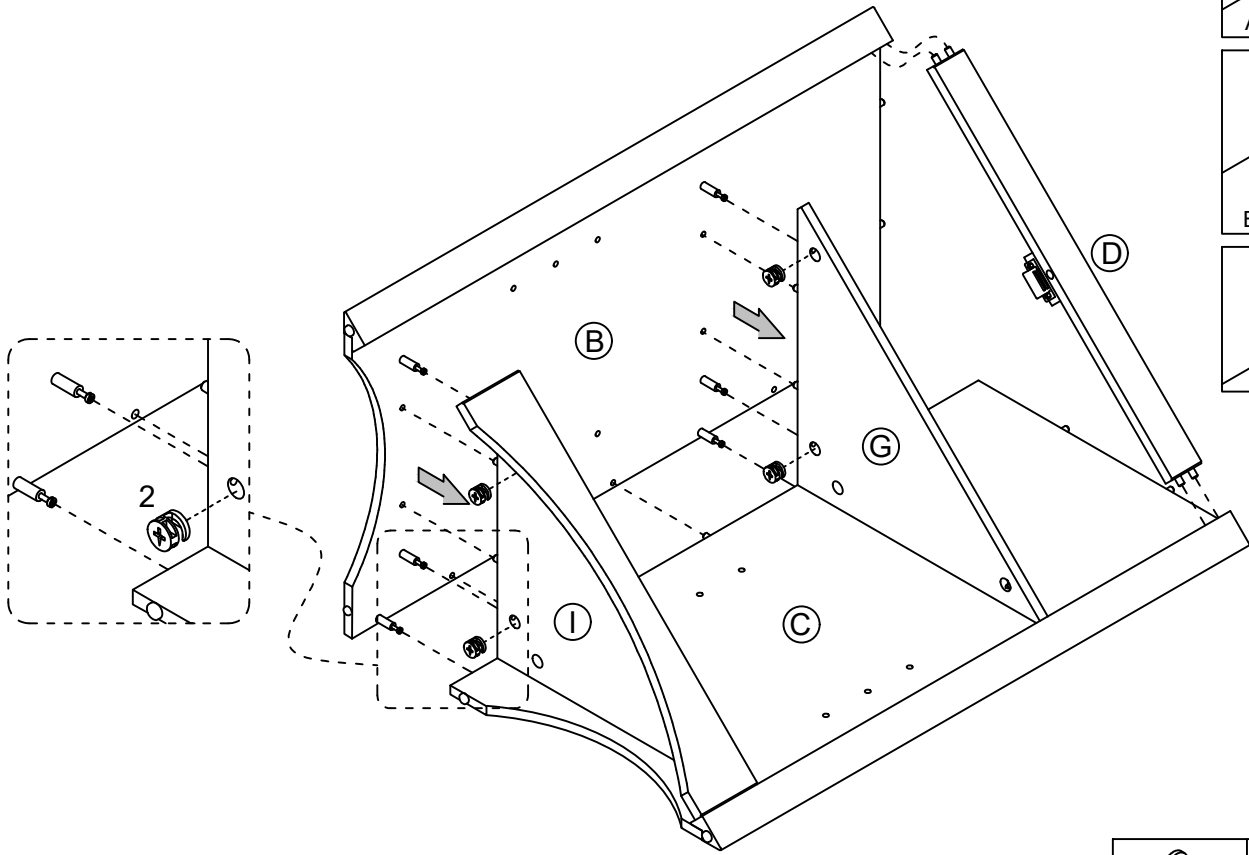

STEP 7

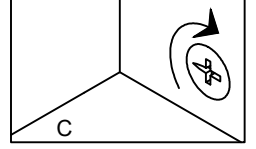
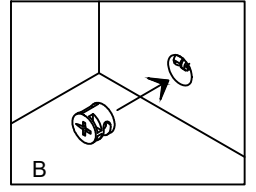
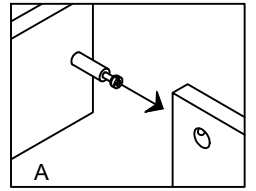
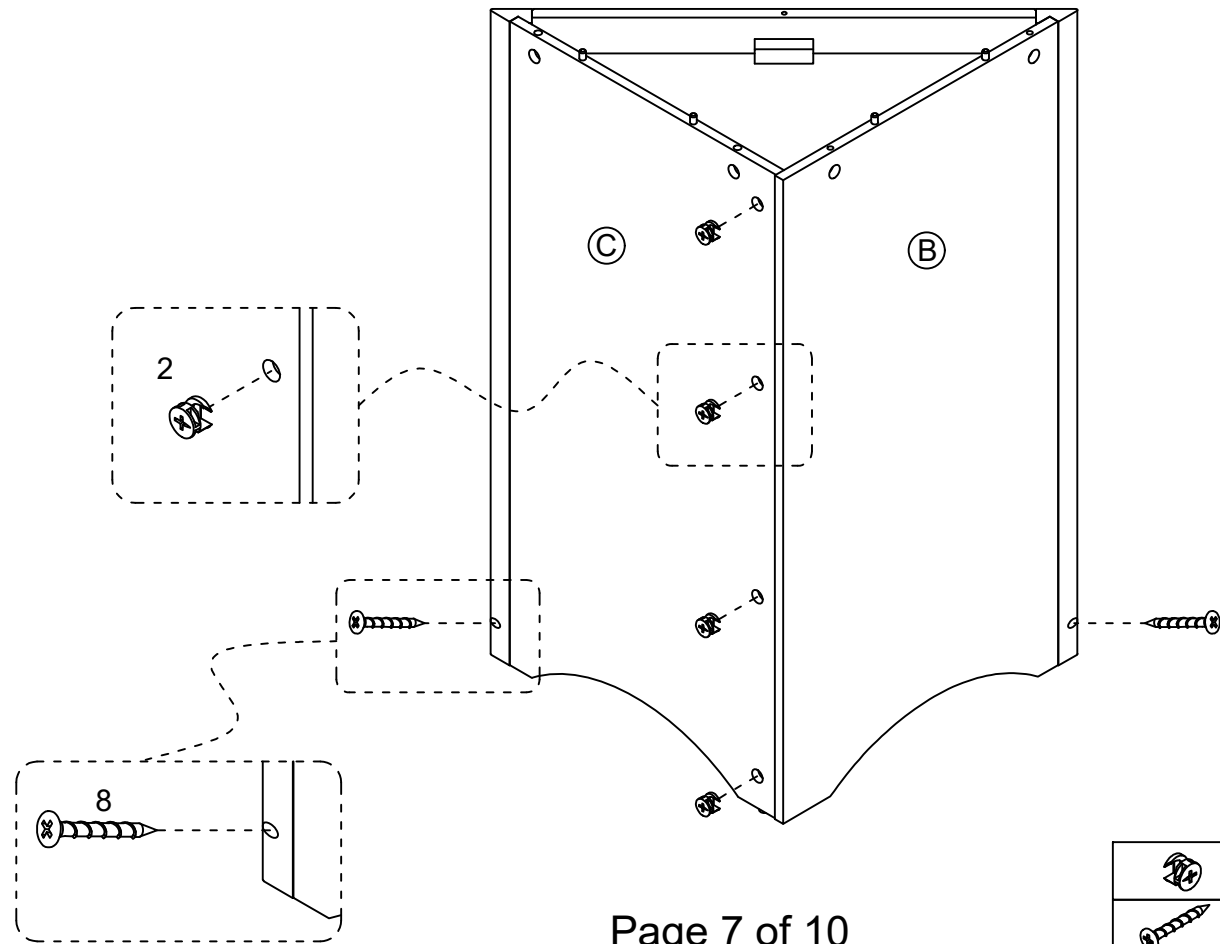

	2 x 4 pcs
---	-----------

STEP 8



	2 x 4 pcs
	8 x 2 pcs

STEP9

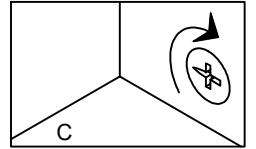
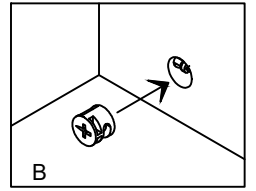
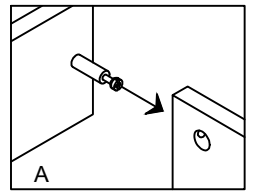
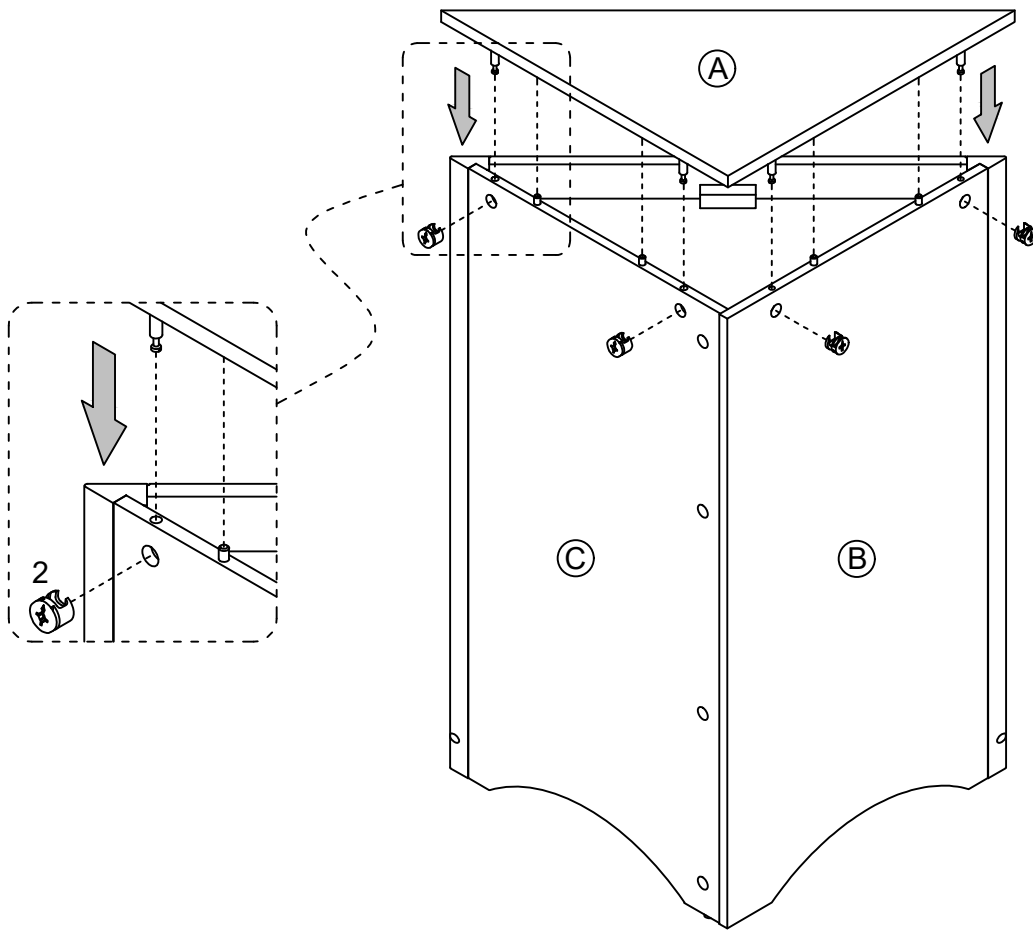

 2 x 4pcs

STEP10

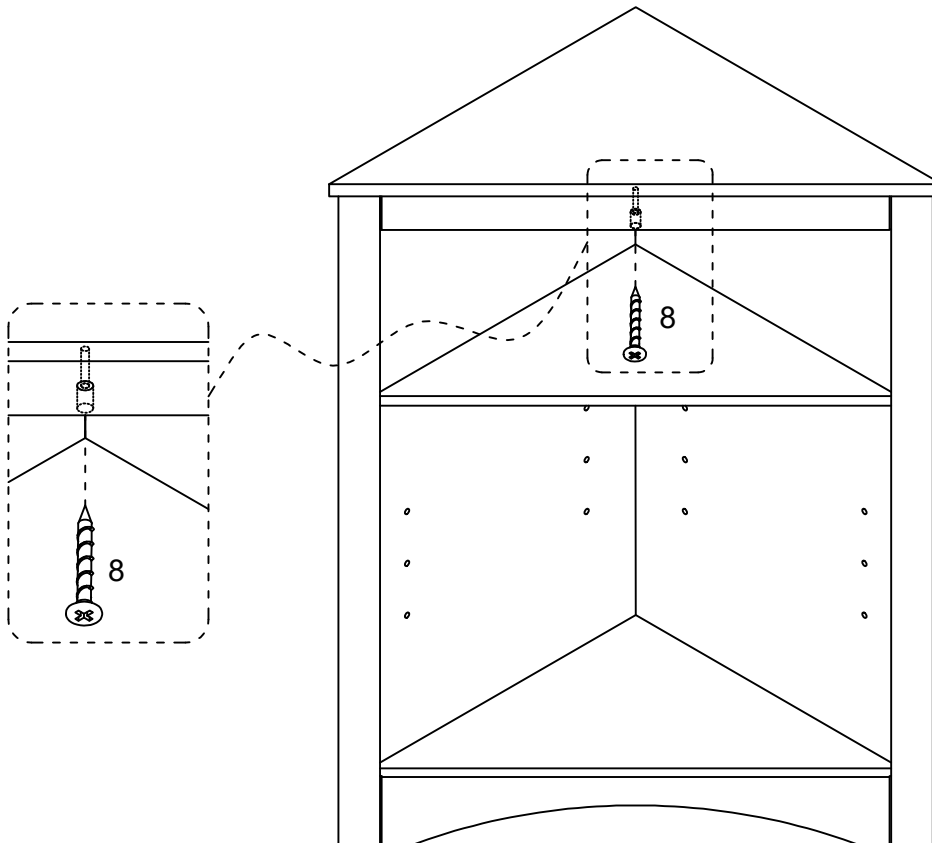

 8 x 1pc

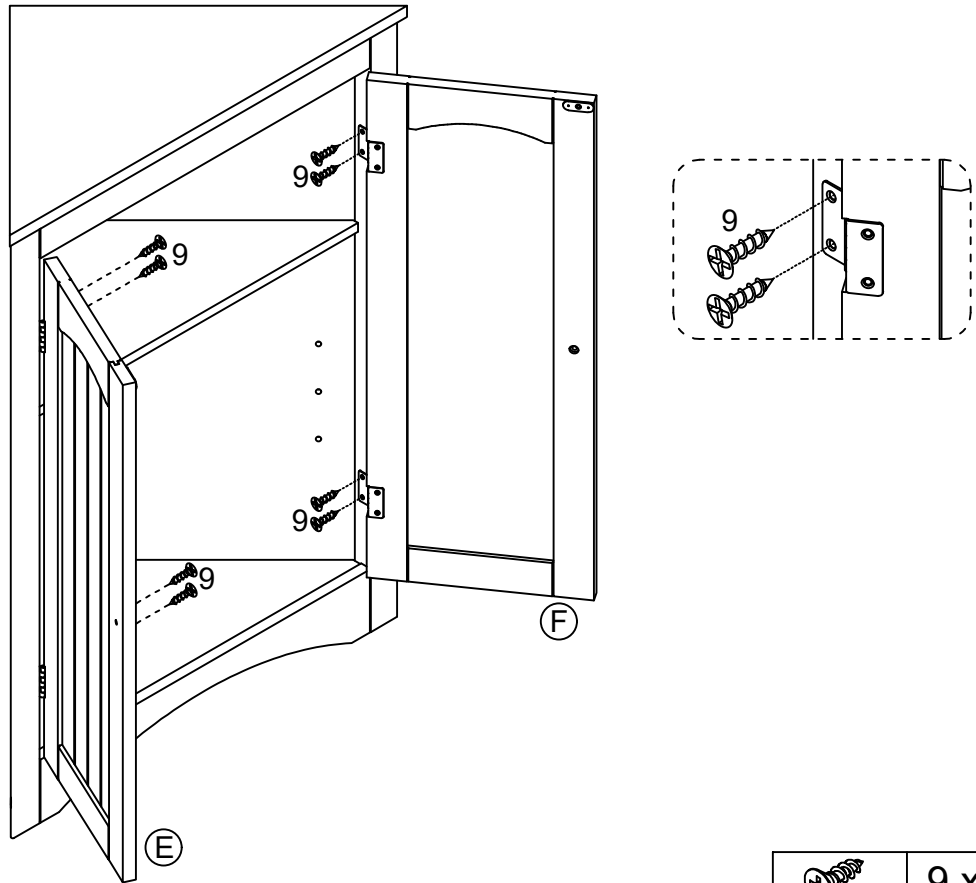

STEP11



	9 x 8pcs
---	----------

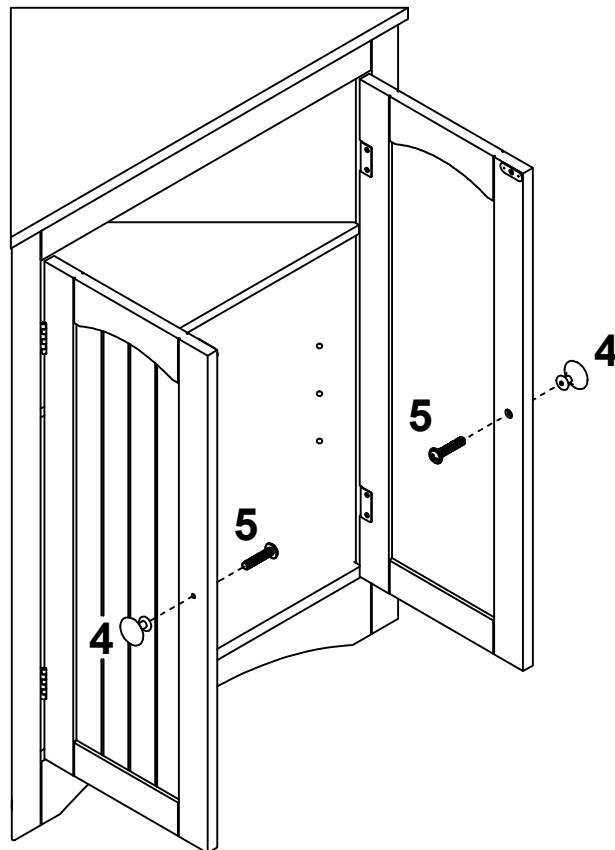

STEP12



	4 x 2pcs
	5 x 2pcs

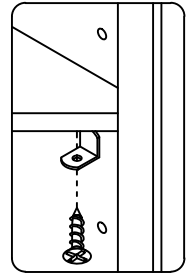
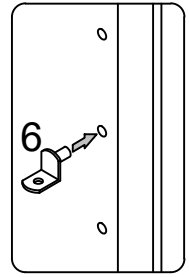
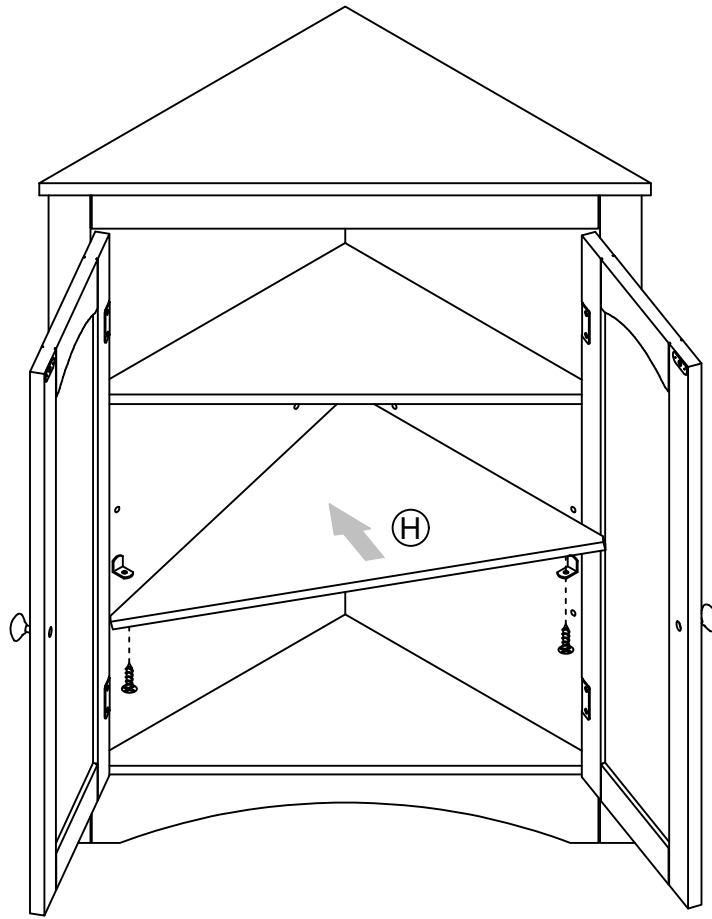





STEP13

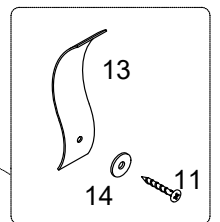
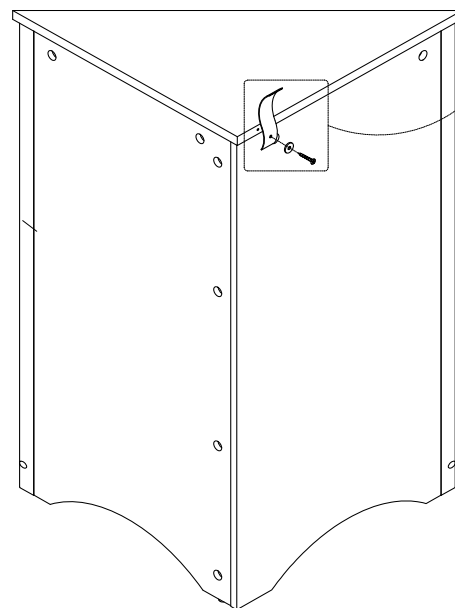
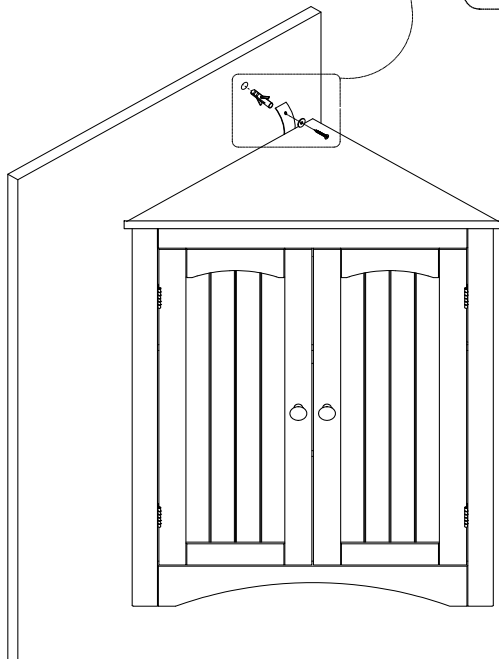
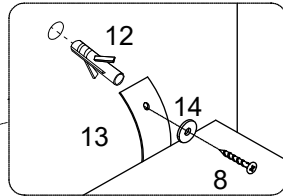

	6 x 4pcs
	7 x 4pcs

STEP14



8		1pc
		1pc
		1pc
		1pc
14		2pcs