

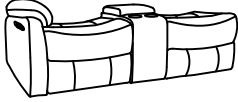







ASSEMBLY INSTRUCTIONS

Motion Sofa

NOTE: Do not use power tools for assembly. Power tools increase the risk of over tightening which lead to splitting or cracking the wood. It is recommended to have two people during assembling.

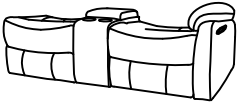
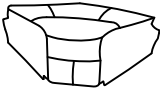
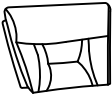
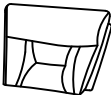
PARTS LIST

NO.	DRAWING	QTY	DESCRIPTION
A		1PC	LSF SEAT
B		1PC	LSF BACK REST
C		2PC	CONSOLE BACK REST
D		2PC	MSF BACK REST
E		1PC	LSF EAR
F		1PC	RSF EAR
G		1PC	RSF BACK REST
H		1PC	RSF SEAT
I		1PC	WEDGE SEAT
J		1PC	WEDGE LSF BACK
K		1PC	WEDGE RSF BACK
L		4PC	BOLT

Please follow the drawings below to assemble the item

Step 1: Console back rest is stored in non-woven bag and put in the bottom of console. Please take out for assembly.

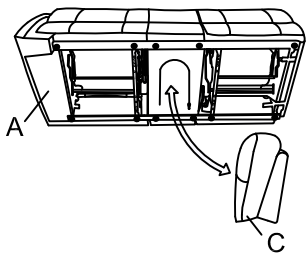

Step 2: Align the female brackets at the back onto the male brackets at the seat, insert back rest to the seat then push to the end and make sure it is fixed in position securely.

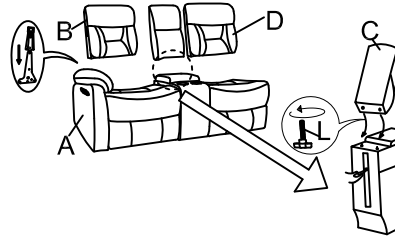

Please unzip the back of the console base and insert the bolts upward through the pre-drilled holes and align it through the holes on the bottom of the console back. Tighten each bolt by turning it counter-clockwise until the console back is secured in place.

Step 3: Please insert the LSF ear to the back rest and make sure it is secured in position.

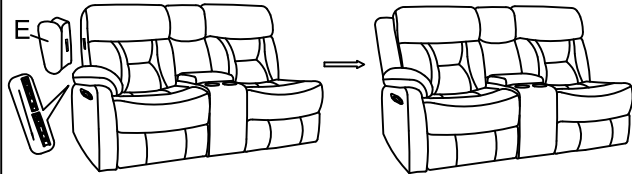

Step 4: Console back rest is stored in non-woven bag and put in the bottom of console. Please take out for assembly.

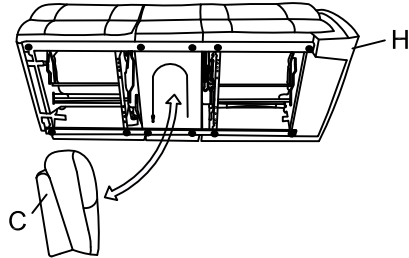

Step 5: Align the female brackets at the back onto the male brackets at the seat, insert back rest to the seat then push to the end and make sure it is fixed in position securely.

Step 6: Please insert the RSF ear to the back rest and make sure it is secured in position.

Please unzip the back of the console base and insert the bolts upward through the pre-drilled holes and align it through the holes on the bottom of the console back. Tighten each bolt by turning it counter-clockwise until the console back is secured in place.

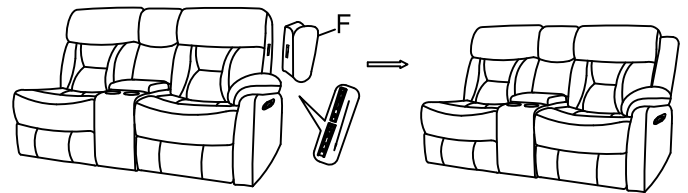
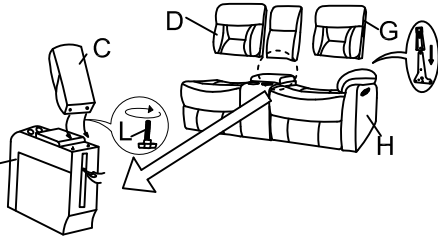

Step 7: Align the female brackets at the back onto the male brackets at the seat, insert back rest to the seat then push to the end and make sure it is fixed in position securely.

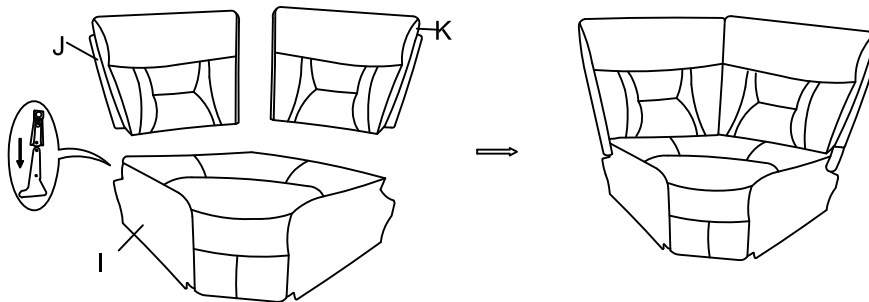

Step 8:

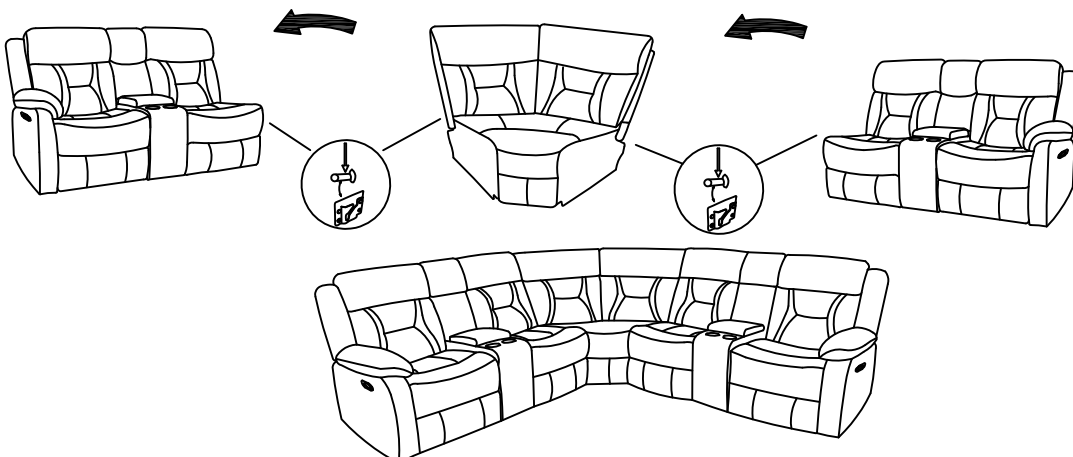

- Avoid exposing furniture directly with sunlight or heating and air conditioning outlets. Exposure to sunlight or heating and air conditioning outlets will fade/damage leather gel.
- Wipe gently with a damp soft cloth to remove dust, dirt and any grime build up.
- Wipe the leather gel with professional cleanser.