

# WARNING!!

**Children have died from furniture tipover. Tip restraints have been included with this product; you must install the tip restraints according to these instructions in order to minimize the risk of furniture tipping. If you have any questions about this product or the tip restraint, please send us an email at [tip\\_restraint\\_help@Noblehousefurniture.com](mailto:tip_restraint_help@Noblehousefurniture.com)**

**NEVER allow children to climb or hang on furniture, including drawers or cabinet doors.**

**In addition to installing the restrains, to help prevent tip-over**  
**1. NEVER put a TV or other heavy objects on top of this product.**

**2. Do not stand on the product**

 <b>WARNING</b>	
	<p><b>Children have died from furniture tipover. To reduce the risk of furniture tipover:</b></p> <ul style="list-style-type: none"><li>• ALWAYS install tipover restraint provided.</li><li>• NEVER put a TV on this product.</li><li>• NEVER allow children to stand, climb or hang on drawers, doors, or shelves.</li><li>• NEVER open more than one drawer at a time.</li><li>• Place heaviest items in the lowest drawers.</li><li>• Do not defeat or remove the drawer interlock system.</li></ul> <p><i>This is a permanent label. Do not remove!</i></p>
	

# Assembly Instructions



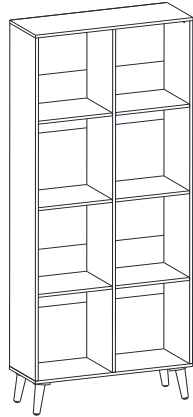

**Caution : You must read this before you proceed**







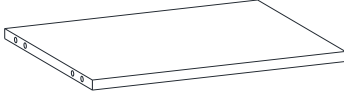
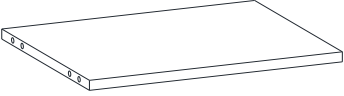

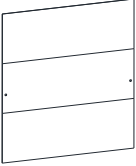
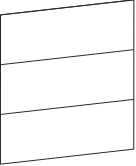
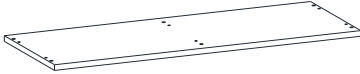
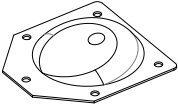

## MULTI-FUNCTIONAL CABINET





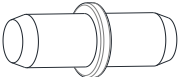

### Parts List

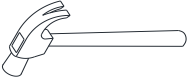
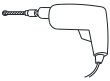
Label	Picture	Description	QTY
A	A perspective drawing of a long, thin rectangular panel, representing the top panel of the cabinet.	Top Panel	1
B	A perspective drawing of a vertical rectangular panel, representing the left side panel of the cabinet.	Left Side Panel (with Metal Bracket)	1

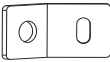
C		Right Side Panel (with Metal Bracket)	1
D		Center Panel	1
E		Left Middle Panel	1
F		Right Middle Panel	1
G		Shelf Panel	4
H		Top Back Panel	1
I		Bottom Back Panel	1
J		Bottom Panel	1
K		Leg Support	4

L		Leg (with pre-fixed PVC Foot)	4
<b>Hardware</b>			
Label	Picture	Description	QTY
①		Cam Lock	15
②		Cam Bolt	15
③		Cam Cap	15
④		Positioning Dowel (φ8*30mm)	21
⑤		Cap Wood Screw (M6*50mm)	7
⑥		Screw (M4*20mm)	21
⑦		Nail	39
⑧		Metal Shelf Support	17
⑨		Allen Key	1
⑩		Screwdriver (not provided)	1
⑪		Hammer (not provided)	1
⑫		Power Drill (not provided)	1

Cabinet Restraint Device Hardware			
⑬		Metal Bracket	2
⑭		Wall Plug	2
⑮		Wall Plug Screw	2
⑯		Cabinet Restraint Strap	4



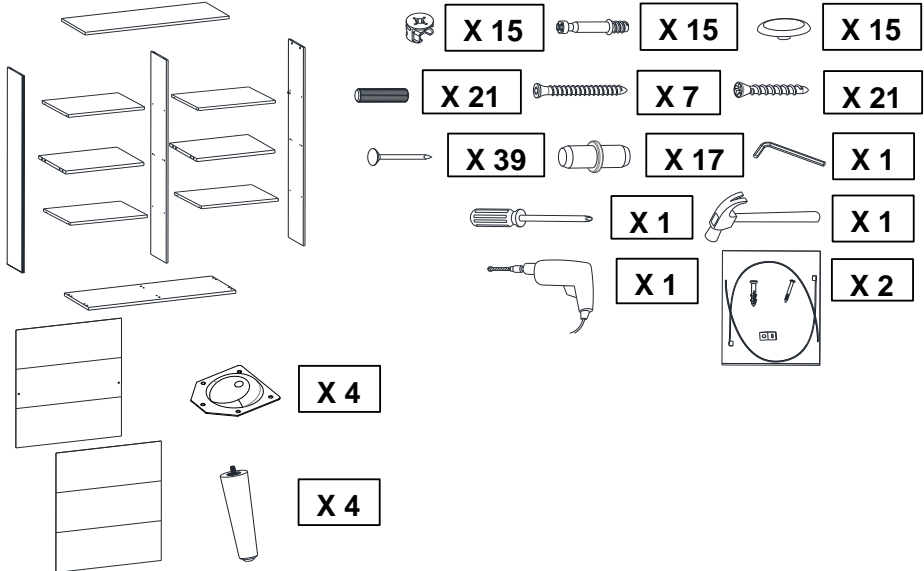

## Assembly Preparation

**Before Beginning Assembly:**



The diagram shows the following parts and tools:

- X 15: Washers
- X 15: Screws
- X 15: Spacers
- X 21: Screws
- X 7: Screws
- X 21: Screws
- X 39: Screws
- X 17: Screws
- X 1: Hex key
- X 1: Screwdriver
- X 1: Power drill
- X 2: Cable lock
- X 4: Locking mechanism
- X 4: Locking mechanism

-  • Read instructions, cover to cover-
-  • Have 2 adults on hand for assembly-
-  • Do not assemble on flooring or carpet-
-  • Assemble on a clean non-marring surface (packing foam)-
-  • Save all packaging until finished-

# Assembly Steps

## Overview

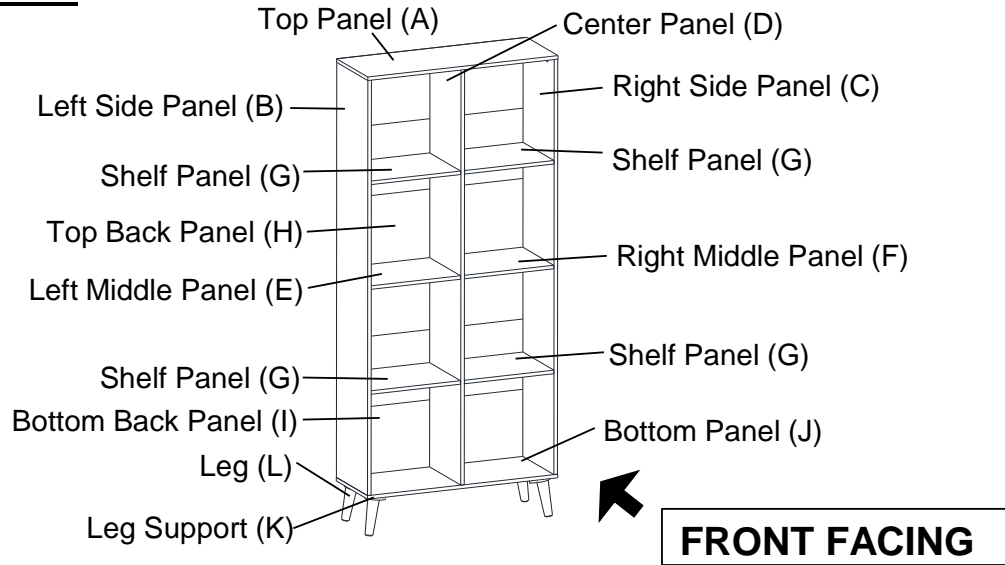

This Multi-Functional Cabinet has multiple parts and may require up to 60 minutes to assemble. To give you an overview of the Multi-Functional Cabinet parts, the above picture is to help you put the various parts into perspective. Please read through the instructions below to familiarise yourself with the parts and steps before assembly.

## Step 1

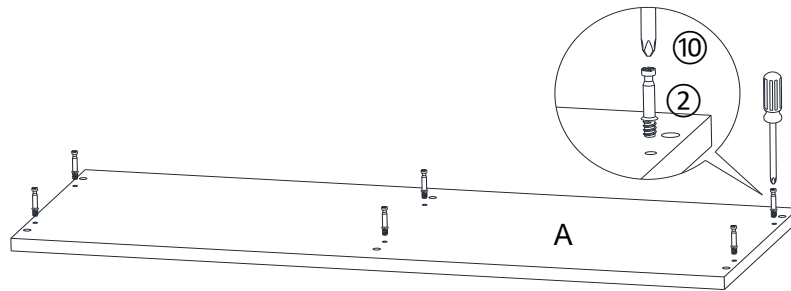

Unpack and place all parts on a clean, non-marring surface. Attach Cam Bolts (2) to mounting positions on Top Panel (A) with Screwdriver (10).

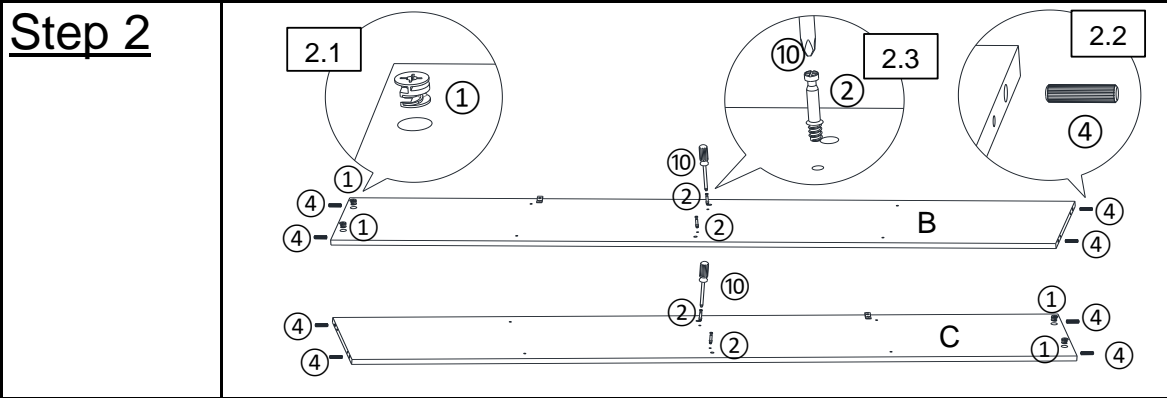

- 2.1)** Insert Cam Locks(①) into mounting positions on Left Side Panel(B) by hand.
- 2.2)** Insert Positioning Dowel(④) into mounting positions on Left Side Panel(B) by hand.
- 2.3)** Attach Cam Bolts(②) to mounting positions on Left Side Panel(B) with Screwdriver(⑩).
- 2.4)** Repeat the same process on the Right Side Panel(C).

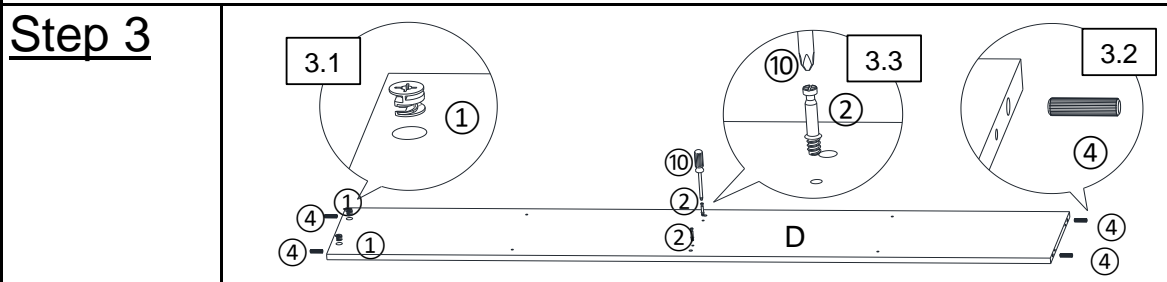

- 3.1)** Insert Cam Locks(①) into mounting positions on Center Panel(D) by hand.
- 3.2)** Insert Positioning Dowel(④) into mounting positions on Center Panel(D) by hand.
- 3.3)** Attach Cam Bolts(②) to mounting positions on Center Panel(D) with Screwdriver(⑩).

## Step 4

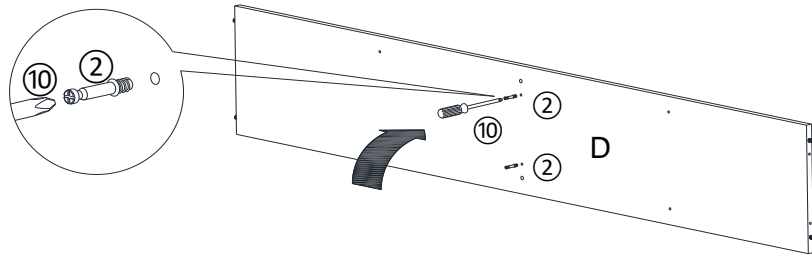

Lift Center Panel(D) upward with help from another adult. Attach Cam Bolts(2) to mounting positions on the opposite face of Center Panel(D) with Screwdriver(10).

## Step 5

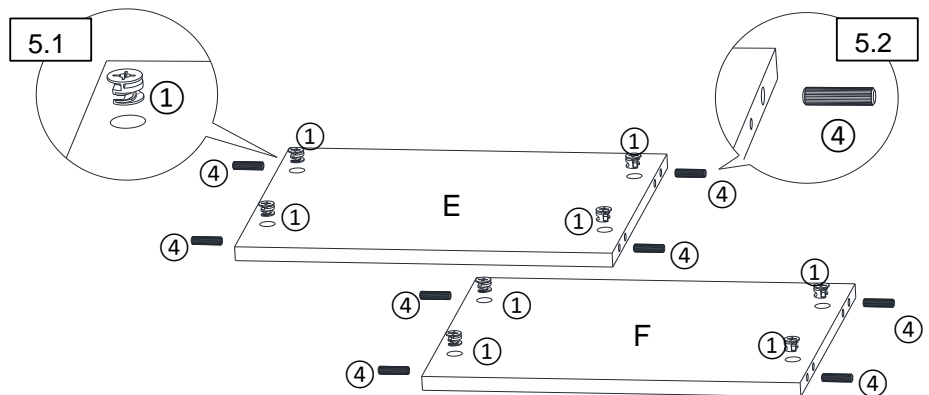

**5.1)** Insert Cam Locks(1) into mounting positions on Left Middle Panel(E) and Right Middle Panel(F) by hand.

**5.2)** Insert Positioning Dowels(4) into mounting positions on Left Middle Panel(E) and Right Middle Panel(F) by hand.

## Step 6

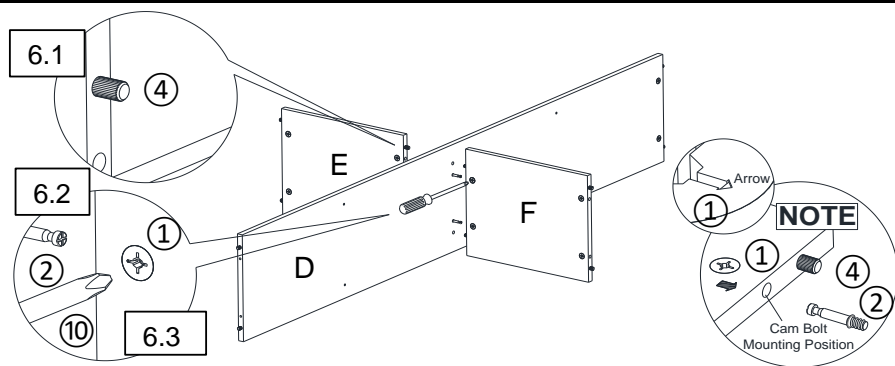

**6.1)** Insert Positioning Dowels((4)) from Left Middle Panel(E) and Right Middle Panel(F) into mounting positions on Center Panel(D).

**Note: Ensure the arrows on Cam Locks head points towards the Cam Bolt mounting positions.**

**6.2)** Insert the mounting positions on side of Left Middle Panel(E) and Right Middle Panel(F) onto Cam Bolts((2)) on Center Panel(D).

**6.3)** Turn the Cam Locks((1)) clockwise with the Screwdriver((10)) until they all lock into place.

## Step 7

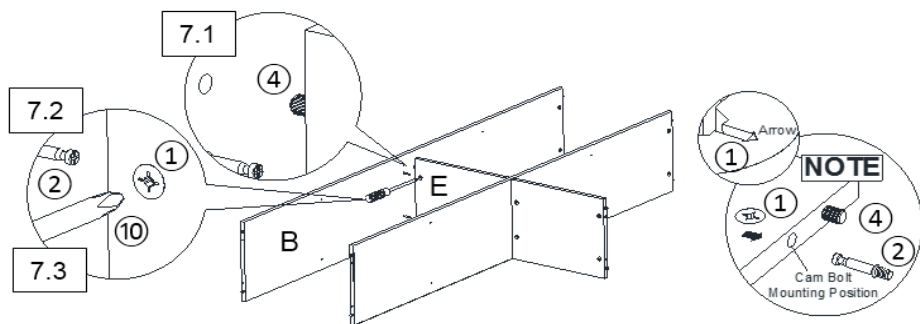

**7.1)** Insert Positioning Dowels((4)) from Left Middle Panel(E) into mounting positions on Left Side Panel(B).

**Note: Ensure the arrows on Cam Locks head points towards the Cam Bolt mounting positions.**

**7.2)** Insert the mounting positions on side of Left Middle Panel(E) onto Cam Bolts((2)) on Left Side Panel(B).

**7.3)** Turn the Cam Locks((1)) clockwise with the Screwdriver((10)) until they all lock into place.

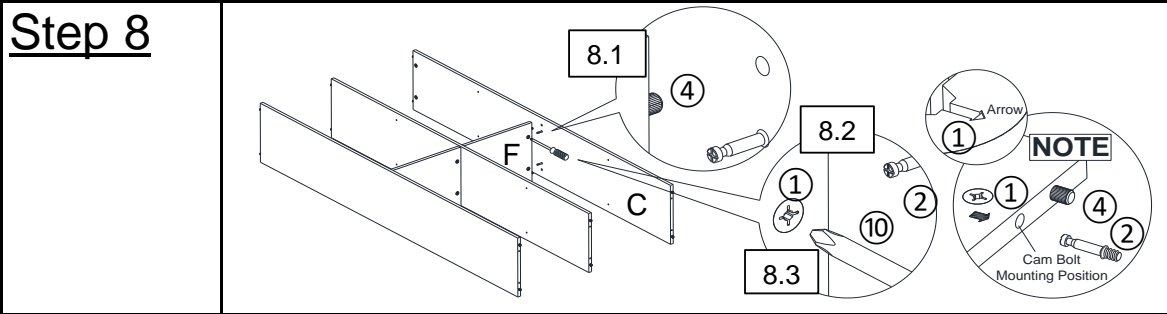

**8.1)** Insert Positioning Dowels(④) from Right Middle Panel(F) into mounting positions on Right Side Panel(C).

**Note: Ensure the arrows on Cam Locks head points towards the Cam Bolt mounting positions.**

**8.2)** Insert the mounting positions on side of Right Middle Panel(F) onto Cam Bolts(②) on Right Side Panel(C).

**8.3)** Turn the Cam Locks(①) clockwise with the Screwdriver(⑩) until they all lock into place.

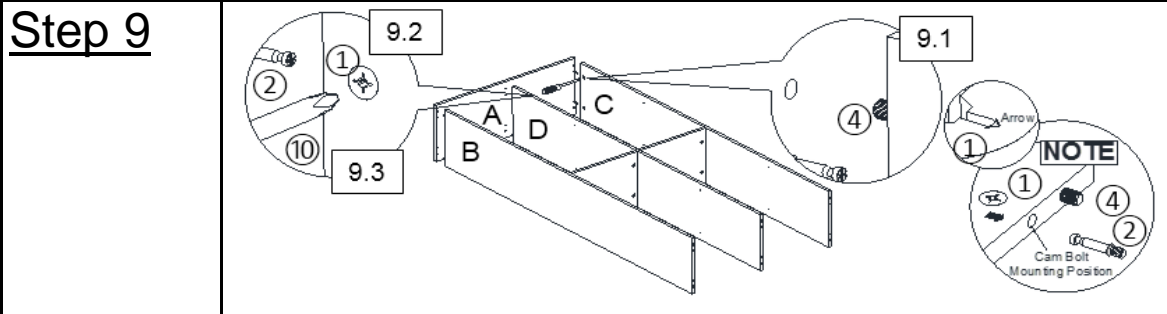

**9.1)** Insert Positioning Dowels(④) from Left Side Panel(B), Right Side Panel(C) and Center Panel(D) into mounting positions on Top Panel(A).

**Note: Ensure the arrows on Cam Locks head points towards the Cam Bolt mounting positions.**

**9.2)** Insert the mounting positions on side of Left Side Panel(B), Right Side Panel(C) and Center Panel(D) onto Cam Bolts(②) on Top Panel(A).

**9.3)** Turn the Cam Locks(①) clockwise with the Screwdriver(⑩) until they all lock into place.

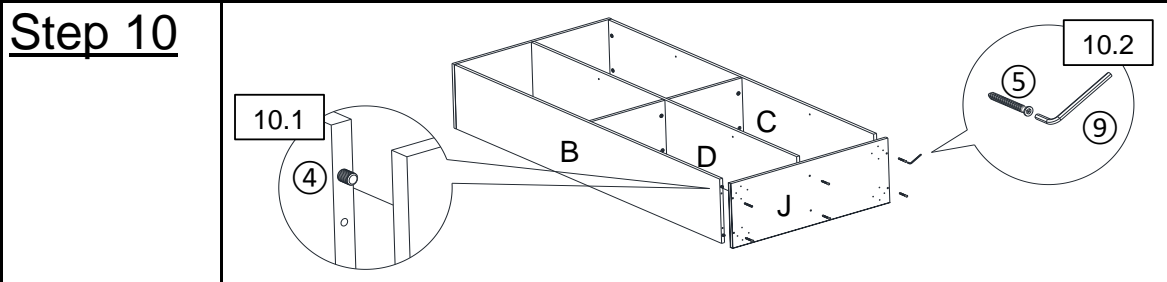

**10.1)** Insert Positioning Dowels(④) from Left Side Panel(B), Right Side Panel(C) and Center Panel(D) into mounting positions on Bottom Panel(J).

**10.2)** Attach Bottom Panel(J) to Cabinet Assembly using Cap Wood Screw(⑤) with Allen Key(⑨).

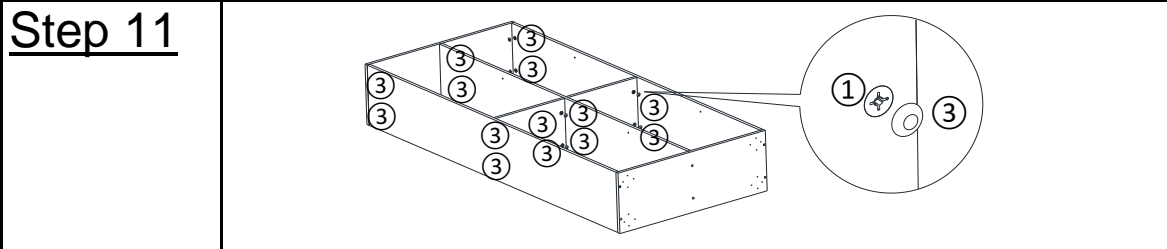

Attach Cam Caps(③) to all Cam Locks(①) by hand.

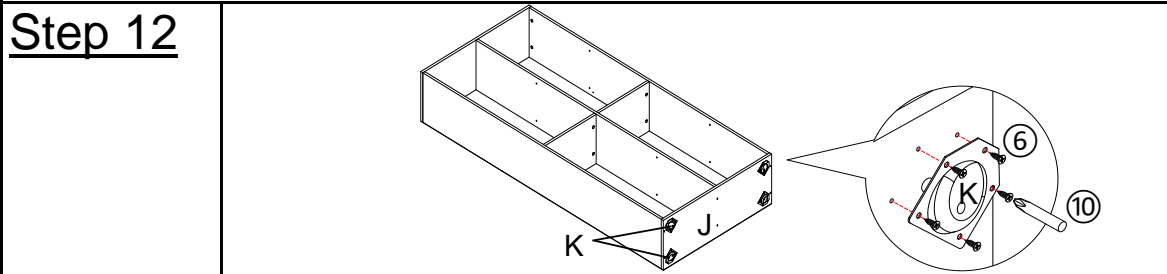

Attach Leg Supports(K) to Bottom Panel(J) using Screws(⑥) with Screwdriver(⑩).

**Tighten the Screws fully in a sequential manner.**

**Note: There are pre-existing mounting positions on the Bottom Panel(J) to attach the Leg Supports(K).**

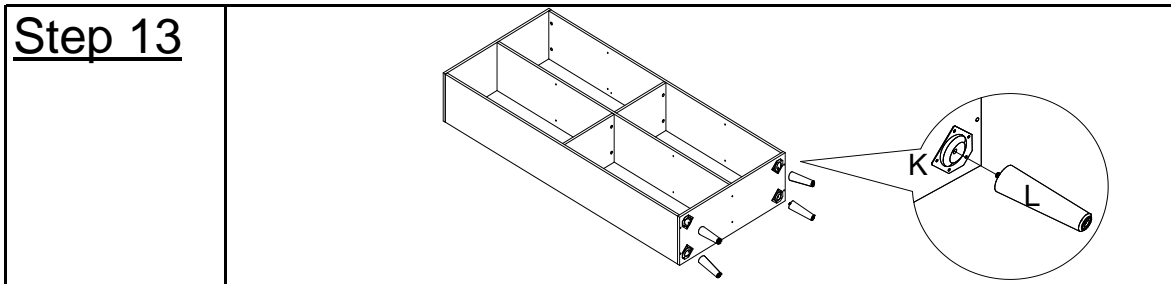

Attach Legs(L) to Leg Supports(K) by rotating clockwise by hand.

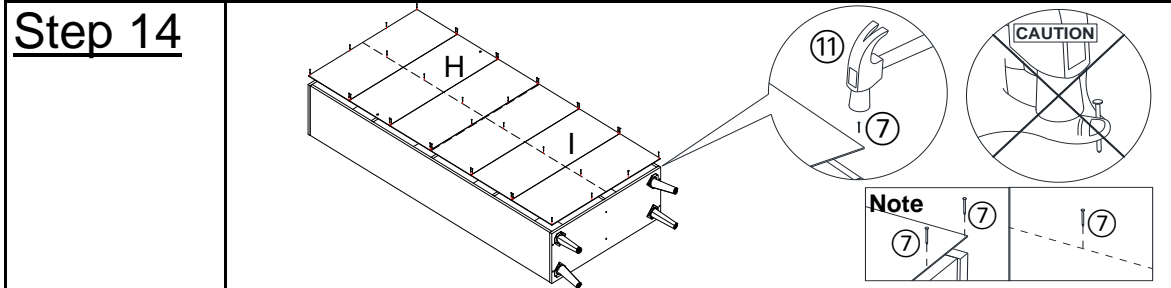

Flip the whole Cabinet over.  
 Attach Top Back Panel(H) and Bottom Back Panel(I) to Cabinet Assembly using Nails(7) with Hammer(11).  
**Please be extra careful when using Hammer to avoid injury.**  
**Note: Hit Nails(7) along all four edges (slightly inwards from sides) on the lines drawn on the Top Back Panel(H) and Bottom Back Panel(I).**  
**Note: There are pre-existing mounting positions on the Top Back Panel(H) to match with Metal Brackets on Left Side Panel(B) and Right Side Panel(C).**

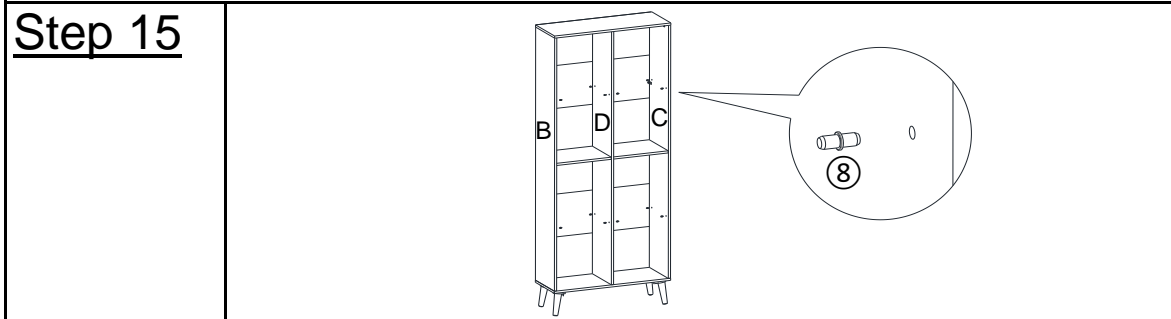

Insert Metal Shelf Supports(8) into mounting positions on Left Side Panel(B), Right Side Panel(C) and Center Panel(D) by hand.

## Step 16

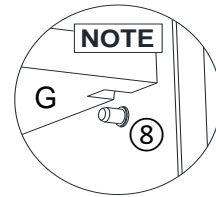
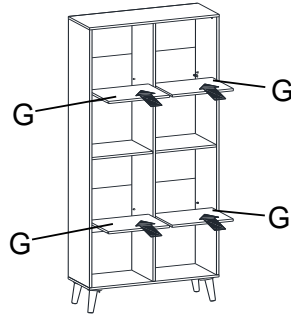

Put Shelf Panels(G) in place on Metal Shelf Supports(8).

**Note: There are lead mounting positions on Shelf Panels(G) to fit Metal Shelf Supports(8).**

### Cabinet Restraint Device Installation Instructions

#### WARNING

Serious or fatal crushing injuries can occur from tipping furniture.  
To help prevent tip-over: ALWAYS secure this furniture to the wall using Cabinet Restraint Device.

See product instructions for more ways to help prevent furniture tip-over.

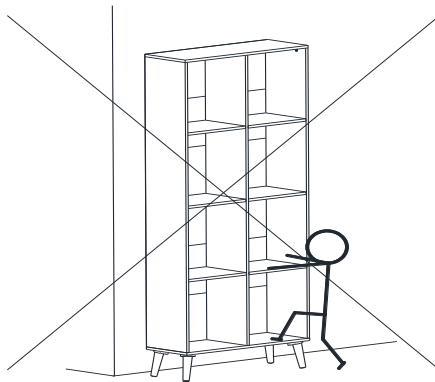

#### Usage For Cabinet Restraint Device:

To secure Multi-Functional Cabinet against wall, attach two Metal Brackets(13) on wall and product, use Cabinet Restraint Strap(16) to connect the Metal Brackets(13).

#### Instructions:

## Step 17

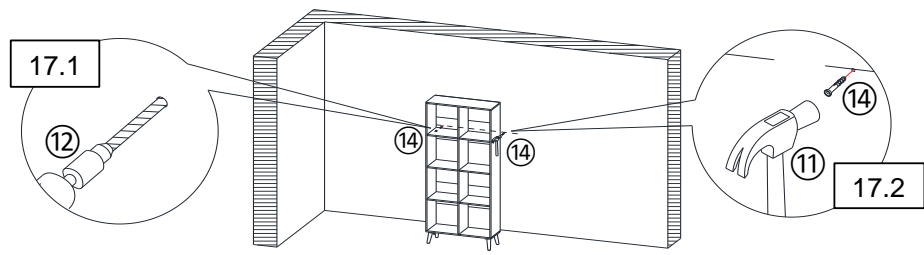

**17.1)** Drill two holes on wall at same height as Metal Brackets(13) on Multi-Functional Cabinet with Power Drill(12).

**You can mark these points in two ways as below:**

1) Move the Multi-Functional Cabinet back to the wall. Mark two points same height as pre-assembled Metal Bracket(13) in Multi-Functional Cabinet on the wall.

**Note: The Metal Brackets need to be secured to solid, load bearing surface. Please use a Stud Finder(not supplied) if needed to locate the Wall Frame.**

2) Measure the height of the Metal Brackets(13) with ruler/measuring tape and mark on wall to keep them accurate and same height.

**17.2)** Insert Wall Plugs(14) into drilled holes on wall with Hammer(11).

## Step 18

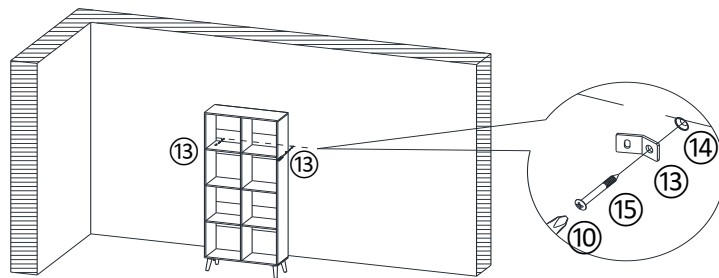

Attach Metal Brackets(13) to Wall Plugs(14) using Wall Plug Screws(15) with Screwdriver(10).

## Step 19

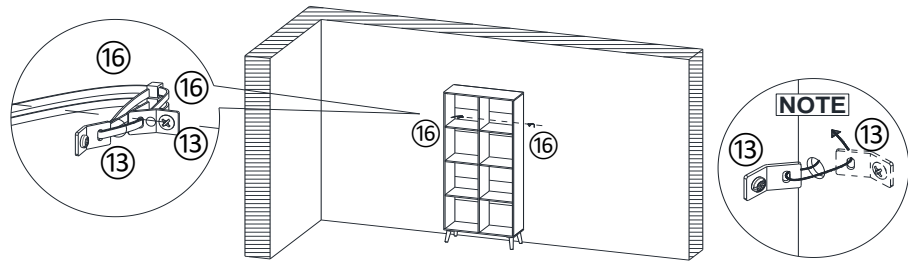

Move Multi-Functional Cabinet to the wall.

Pull the both of Restraint Straps(16) through the Metal Brackets(13) on the wall and Multi-Functional Cabinet one by one, and pull the both of Restraint Straps(16) tight.

**Note: There are lead mounting positions on Top Back Panel(H) to allow two Restraint Straps(16) to insert through.**



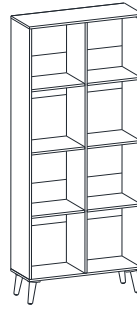







## Step 20



Your Multi-Functional Cabinet is ready for use.

**This Multi-Functional Cabinet can only be used on a flat, level surface.**

## Care & Maintenance

- ✓  Furniture may scratch floors. We recommend using furniture pads to protect your floors.
- ⊘  Do not put hot items directly on furniture surface.
- ⊘  Do not clean furniture with harsh cleansers or polish.
- ⊘  Do not place furniture under direct sunlight.
- ⊘  Do not place furniture near heating or cooling vents.
- ⊘  Do not write on furniture without a padded barrier to protect the surface.
- ⊘  Do not place furniture outside . For indoor use only.
- ⊘  Not for commercial use. For residential use only.
- ⊘  Stains may be removed with mild soap solution and damp cloth.
- ⊘  Children should not climb or jump on the furniture.
- ✓  Dust and pick-up spills using a clean, non-colored, lint-free cloth.