

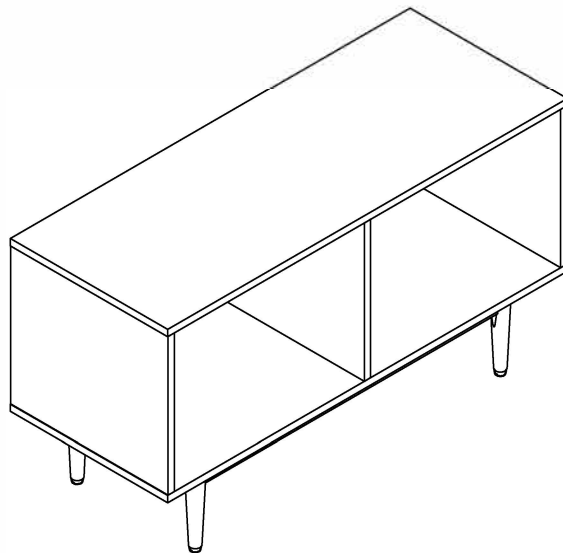

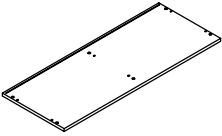

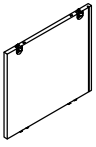

Medium Record Storage Console Cabinet

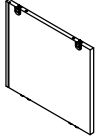
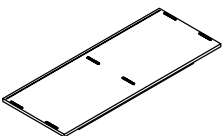
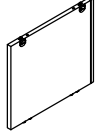
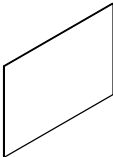

PART LIST

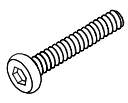
				
<p>Top Panel 1 PC</p>	<p>Left Panel 1 PC</p>	<p>Right Panel 1 PC</p>	<p>Bottom Panel 1 PC</p>	<p>Partition Panel 1 PC</p>
				
<p>Back Panel 2 PCS</p>	<p>Leg 4 PCS</p>			

HARDWARE LIST

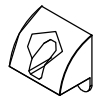
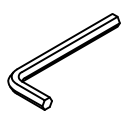
				
<p>Ø3*15mm Screw 4 PCS</p>	<p>Ø1/4"*1-1/2" Bolt 8 PCS (Extra 1)</p>	<p>Ø1/4" Flat Washer 8 PCS (Extra 1)</p>	<p>Ø1/4" Spring Washer 8 PCS (Extra 1)</p>	<p>Ø8*30mm Wood Dowel 6 PCS</p>
				
<p>Back Bracket 4 PCS</p>	<p>4mm Allen Wrench 1 PC</p>			

ADDITIONAL TOOLS (Not Provided)

Note: It is not recommended to use power tools during assembly.

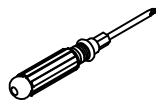

Phillips Head Screwdriver

Note: Wood dowels are intended for alignment. Additional clearance between wood dowel and pre-drilled hole is intentional for ease of assembly.

Please do not use tools to assemble this unit unless specifically indicated.

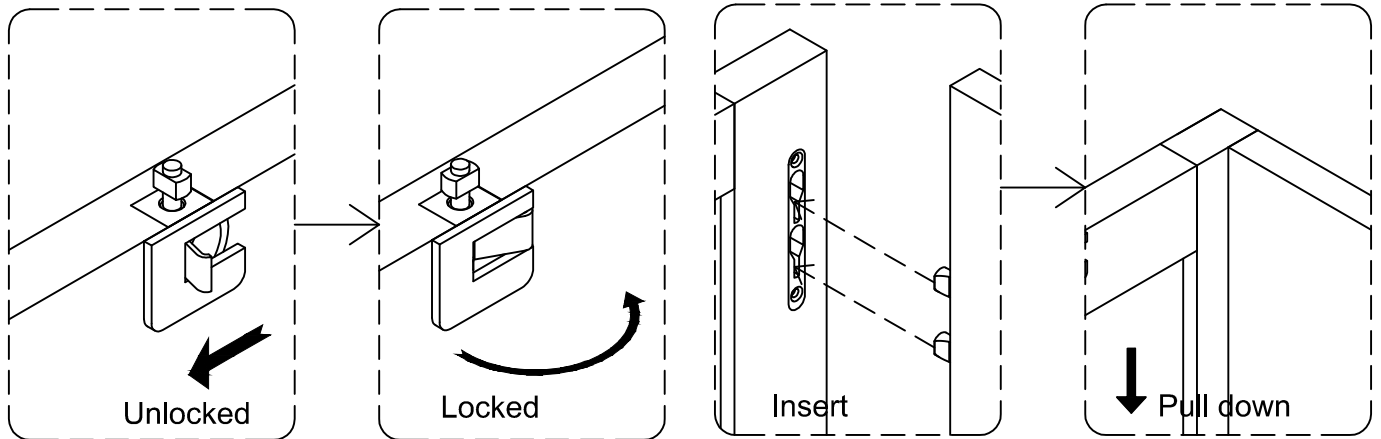

Reference the images above any time the instructions state "lock the hardware" or "insert hardware and pull down to lock".

Be sure to check all hardware is locked when complete.

Step 1. Attach legs (part G) to bottom panel (part D) using spring washers (part #4), flat washers (part #3), bolts (part #2) and allen wrench (part #7).

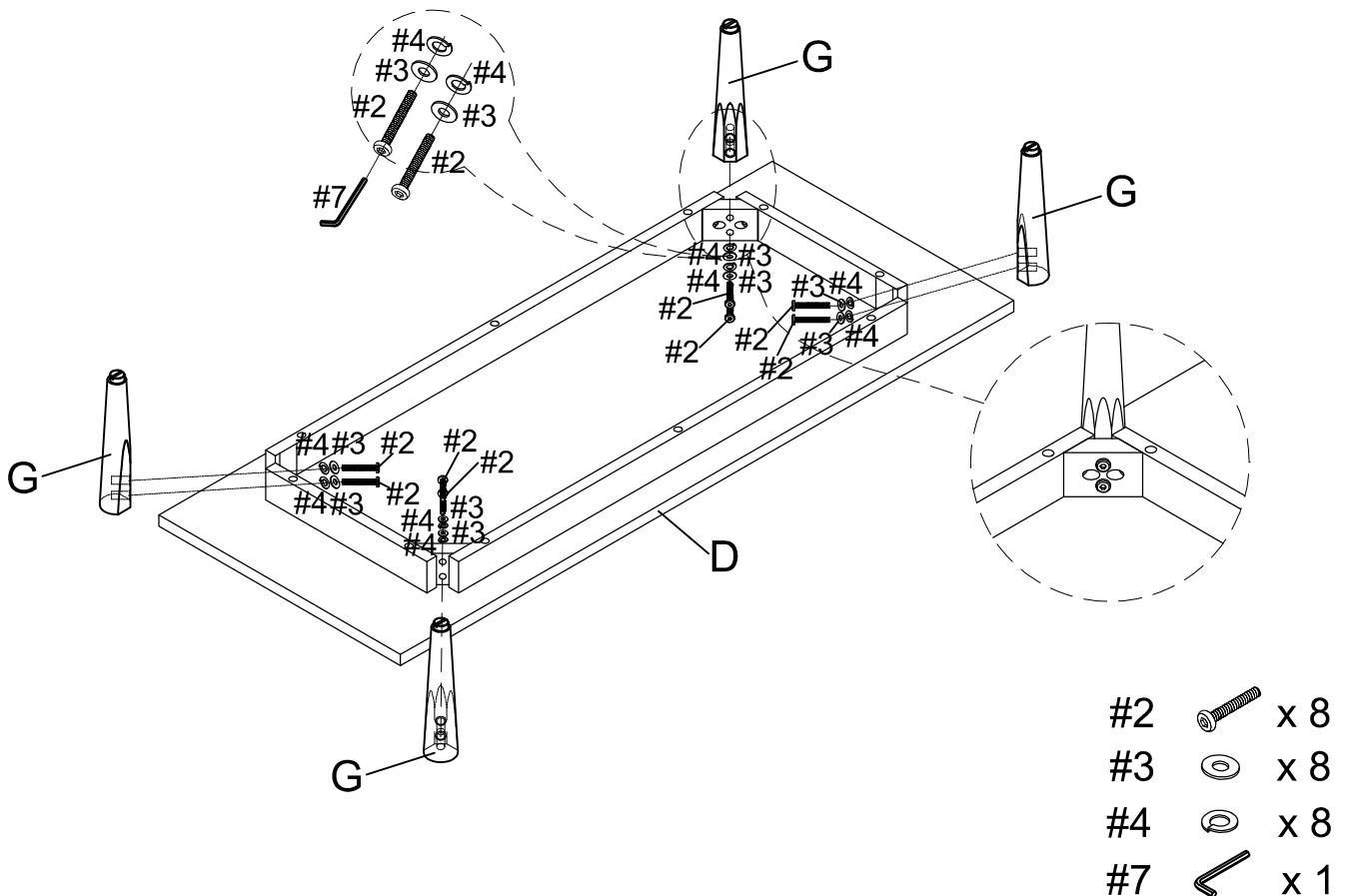

Step 2. Carefully turn unit upright. Attach left panel (part B), right panel (part C) and partition panel (part E) to bottom panel (part D) pull down to lock.

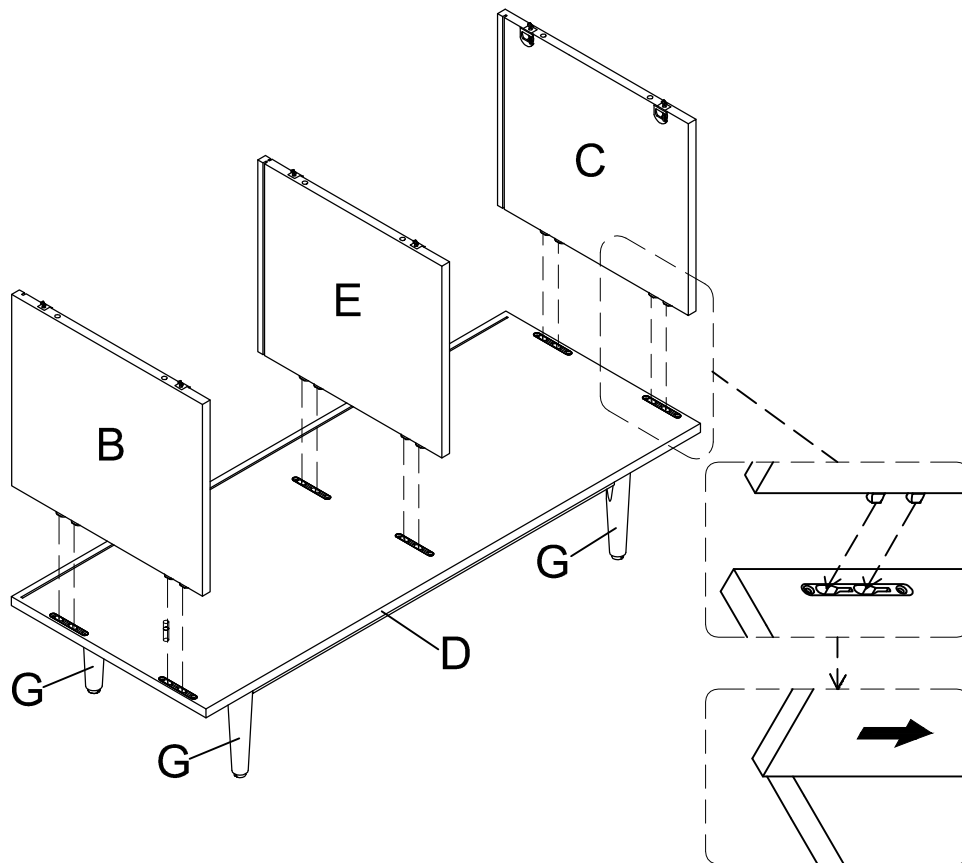

Step 3. Insert back panels (part F) into grooves of assembled unit (parts B, C, D & E).

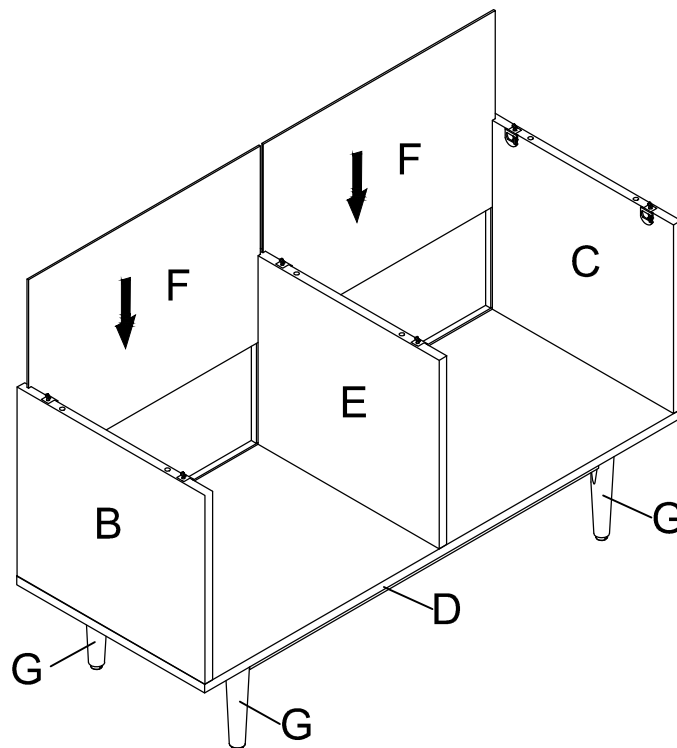

Step 4. Attach top panel (part A) to assembled unit (parts B, C & E), using wood dowels (part #5) and lock the hardware.

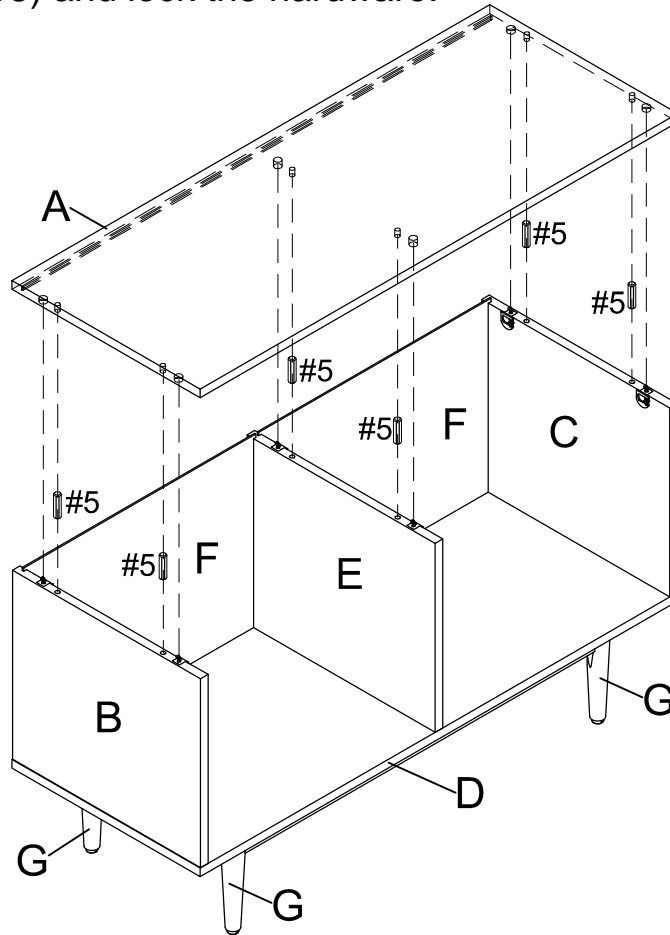

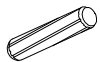
#5  x 6

Step 5. Secure back brackets (part #6) at the corner of back panels (part F) using screws (part #1) and phillips head screwdriver.

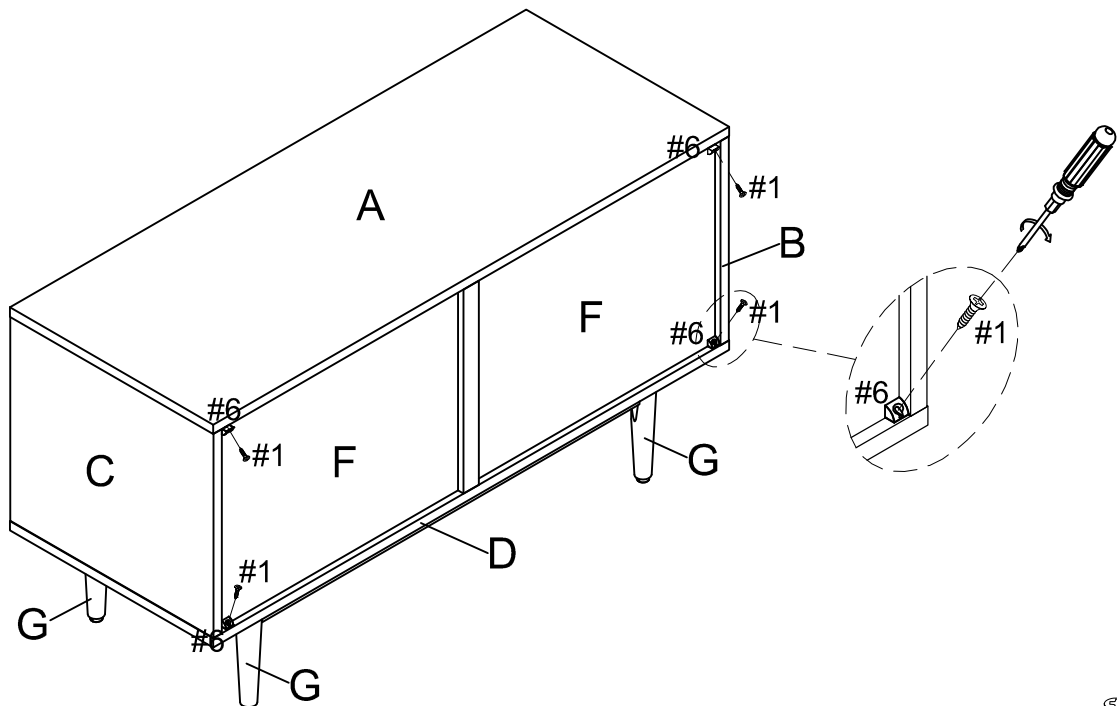

#1  x 4

#6  x 4