

DINING TABLE WITH 6 CHAIRS

TABLE INSTRUCTION MANUAL

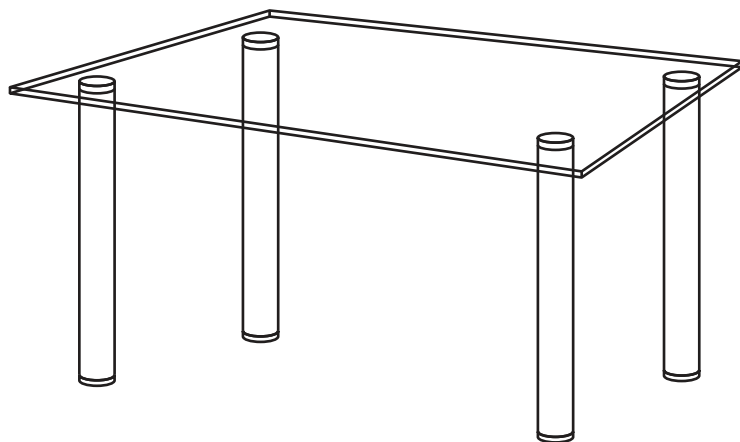

CONTENTS

Safety and care advice	1
Components	2
Assembly instructions	3
Copyright	6

⚠ SAFETY AND CARE ADVICE ⚠

PLEASE READ THESE INSTRUCTIONS CAREFULLY AND KEEP FOR FUTURE REFERENCE

- **Warning:** This unit weighs approximately 24kgs. Please lift with care.
- Check you have all the components and tools listed on pages 2.
- Remove all fittings from the plastic bags and separate them into their groups.
- Keep children and animals away from the work area, small parts could choke if swallowed.
- Make sure you have enough space to layout the parts before starting.
- Do not stand or put weight on the product, this could cause damage.
- Assemble the item as close to its final position (in the same room) as possible.

- Assemble on a soft level surface to avoid damaging the unit or your floor (use opened out unit carton).



- We do not recommend the use of power drill/drivers **for inserting screws**, as this could damage the unit. Only use hand screwdrivers.
- **Safety note:** If there is any chance of this unit being pulled over by children etc. it is recommended that the unit is secured to a wall using suitable fixings (not supplied).
- Dispose of all packaging carefully and responsibly.

CARE AND MAINTENANCE

- Only clean using a damp cloth and mild detergent, do not use bleach or abrasive cleaners.
- From time to time check that there are no loose screws on this unit.

- This product should not be discarded with household waste. Take to your local authority waste disposal center.

Note *If required the next page can be cut out and used as reference throughout the assembly. Keep this page with these instructions for future reference.*

COMPONENTS

Ensure the following components are in the box before proceeding with assembly:



A_{x1}

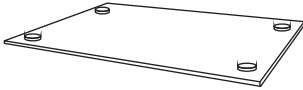

D_{x4}



B_{x4}



E_{x4}



C _{x4}

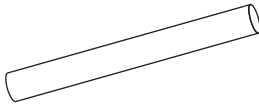

F_{x4}





G _{x1}



ASSEMBLY INSTRUCTIONS

Step 1



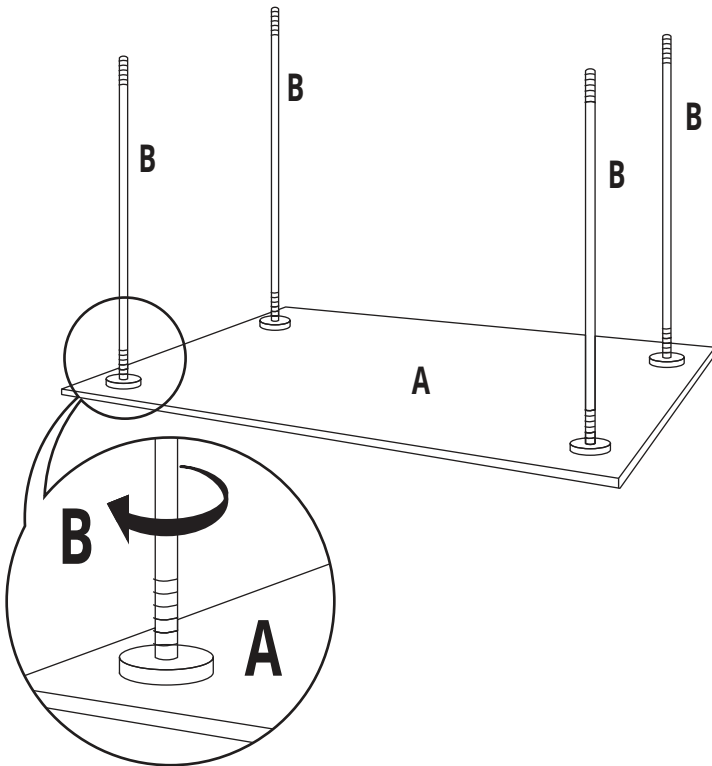

A		1
B		4

TABLEx1



ASSEMBLY INSTRUCTIONS

Step 2

C		4	D		4
			E		4
			F		4
			G		1

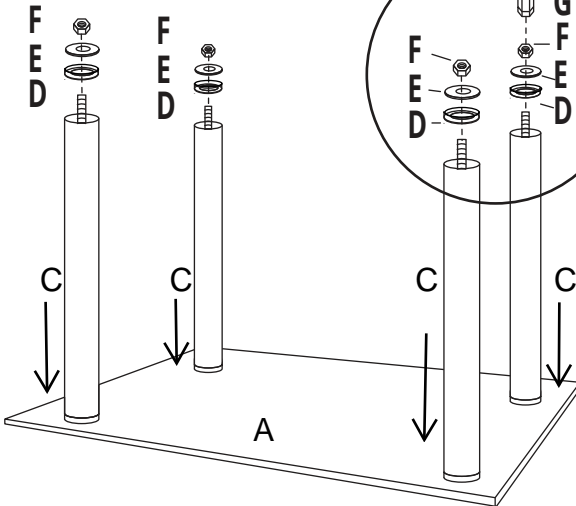
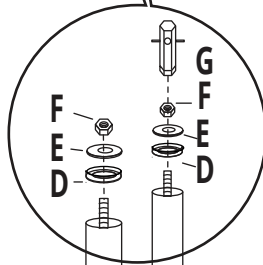
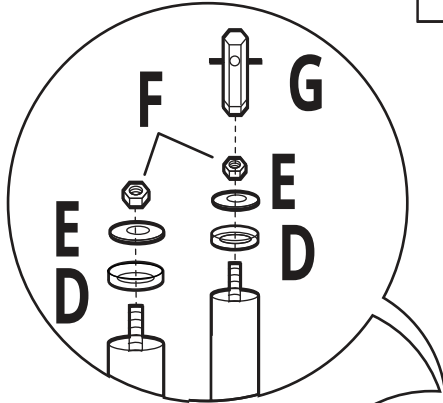

ASSEMBLY INSTRUCTIONS

Step 3

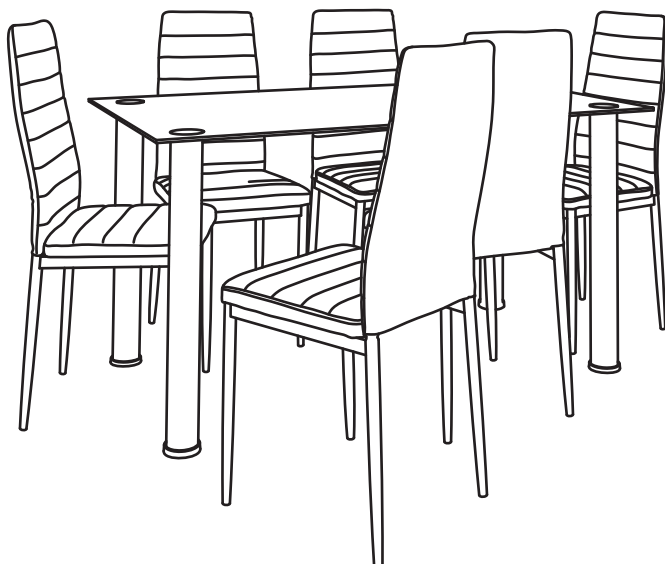
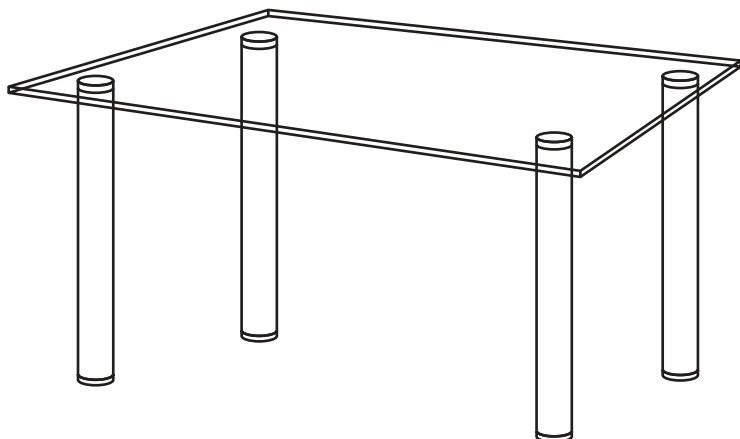

Congratulations! Now you have finished assembling the product. There may be some dust or hand marks on your item, we recommend using a lens cloth to clean this product.

IF YOU FIND A DEFECTIVE PART

We fully stock all parts and components. Any defective part can be quickly replaced. Take note of the defective part number in manual and we will arrange a replacement.

COPYRIGHT

All material in this instruction manual is copyrighted .

Any unauthorised use may violate worldwide copyright, trademark and other laws.

Thank you for purchasing!