

ASSEMBLY AND INSTALLATION INSTRUCTIONS

Model:CA2660-2WM

WARNING: TO AVOID RISK OF ELECTRICAL SHOCK, BE SURE TO SHUT OFF POWER WHILE INSTALLING OR SERVICING THIS FIXTURE

NOTES: 1.Before installing, consult local electrical codes for wiring and grounding requirements.
2.READ AND SAVE THESE INSTRUCTIONS.

To work properly,you should install this fixture NOT confront any jets of air conditions or strong airflow

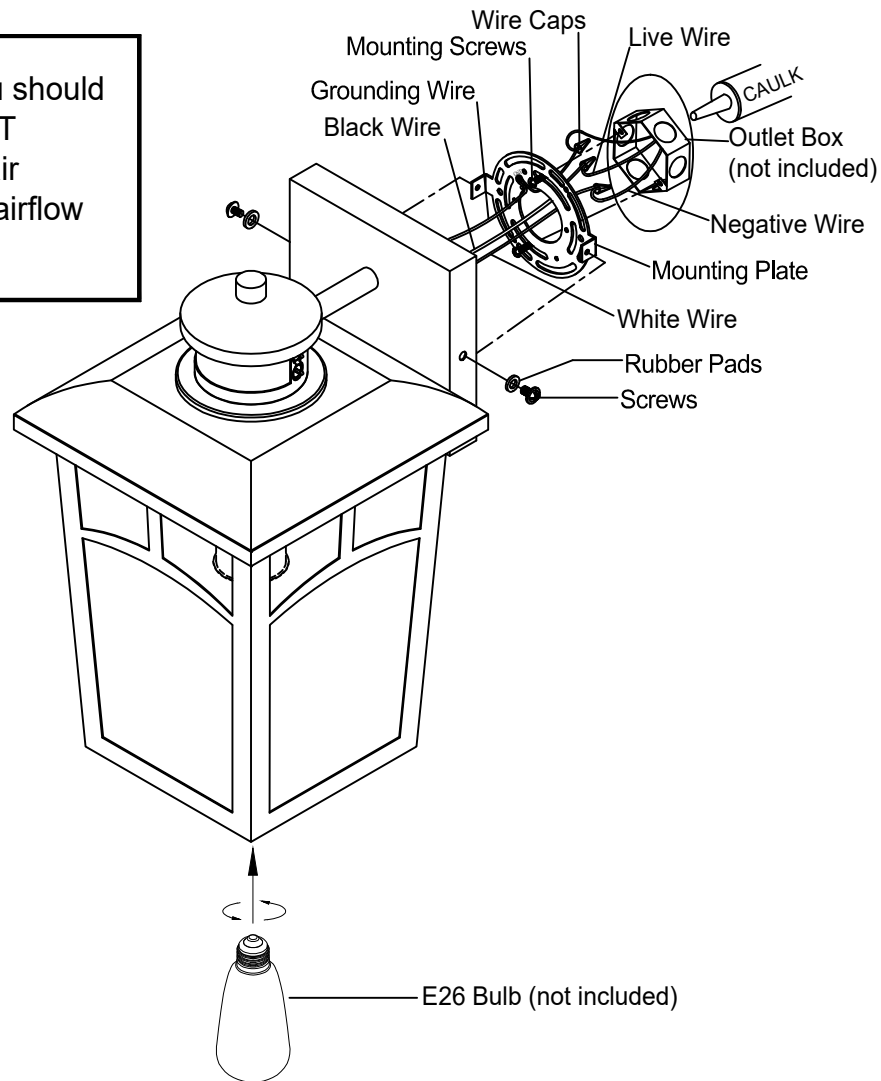

- 1.Attach the mounting plate to the outlet box by using two mounting screws.
- 2.Pull out the wires and grounding wire from the outlet box. Make wire connections using the wire nuts, as follow:
---Connect the hot wire(usually black insulation)from the fixture to the black wire from the power source.
---Connect the neutral wire(usually white insulation)from the fixture to the white wire from the power source.
---Attach the fixture grounding wire(usually green insulation or bare wire)to the mounting strap with the green grounding screw.Then connect it to the house grounding wire with the wire nut.Carefully put the wires back into the outlet box.
- 3.Insert the mounting plate into the back plate, align the two dental grain holes of the mounting plate with the back plate hole, and then fixed with two rubber pads and two screws .
- 4.Install the E26 Bulb(Bulb is not included).

CAUTION: With silicone caulking compound, caulk completely around where the back plate meets with the wall surface to prevent water from seeping into the outlet box.

Turn on the power at fuse or circuit box.

Function and Operation

NOTE

1. The sensitivity of the motion sensor will naturally increase as the environmental temperature decreases. To ensure the best performance, it is recommended to periodically clean the sensor lens with a soft cloth every 1 or 2 months. This will help maintain maximum sensitivity and reliability.
2. To minimize potential disturbances, it is recommended not to install the fixture in close proximity to heat sources such as air conditioners, vents, furnace exhausts, or facing reflective objects or other light sources.

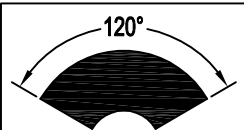

The sensor has a detection range of 120 degrees.



For optimal performance, it is recommended to install the fixture at a height of 6 to 8 feet above the ground. At this height, the lantern will offer a detection distance of up to 40 feet at a temperature of 77 degrees Fahrenheit.

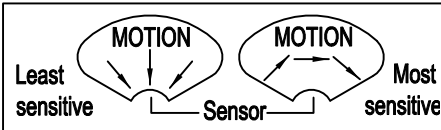

The sensor is designed to be more sensitive to motion across its detection path rather than motion directly towards it.

DEFAULT MODE (AUTO MODE)

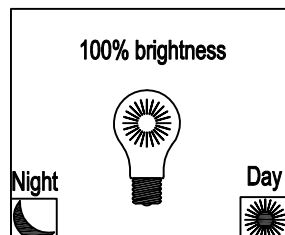

WARM UP: Turn on power at main fuse or circuit breaker box, the light will turn on immediately. Wait for about 20 seconds to allow the sensor to warm up, then the light will automatically enter into **Dual-bright Test Mode**

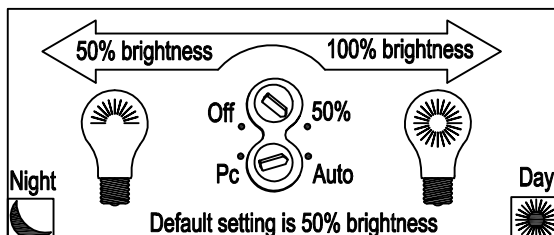

Dual-bright Test Mode: The light will turn on at low-level brightness in the test mode. Default setting is 50% brightness. When motion is detected, the light will turn to 100% brightness, and stay on as long as the motion is continuing. The light will revert to low-level brightness about 5 seconds after motion is no longer detected.

Note: The time of Test Mode is approximately 120 seconds, after which the light will automatically enter into the Dual-bright Mode.

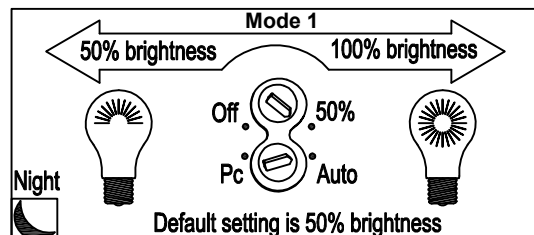

Dual-bright Mode (Auto mode): At dusk, the light will activate at 50% brightness. When motion is detected, the light will turn to 100% brightness, and stay on as long as the motion is continuing. The light will revert to low-level brightness about 120 seconds after motion is no longer detected.

Note: In this mode, the light turns off at dawn and remains off during the day, then automatically turns on at dusk.

MODES OF OPERATION

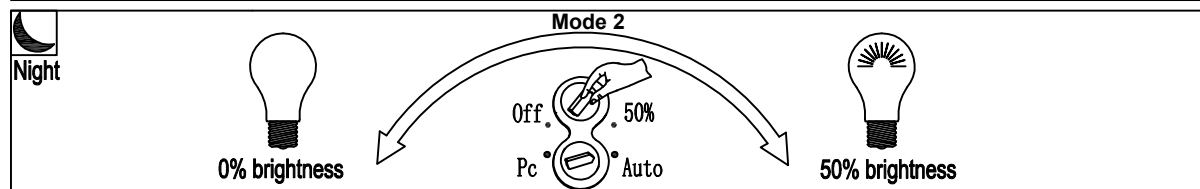

Low-level brightness adjustment: Low-level brightness of **Dual-bright Mode (Auto mode)** can be adjusted from 50%~0% by rotating the upper dial. This operation will automatically activate the **Dual-bright test mode** again, allowing you to make the desired changes more conveniently.

ON/OFF Mode (Auto+ Mode): When the upper dial is turned to the 'Off' position, at dusk, the light will turn on at high-level brightness (100% brightness) when motion is detected, and stay on as long as the motion is continuing. The light will turn off in about 120 seconds after motion is no longer detected.

Note: In this mode, the light automatically turns off at dawn and remains off during the day, then automatically turns on at dusk when motion is detected.

☆ For adjusting the brightness and utilizing the motion detection functions, it is crucial to keep the lower dial in the 'Auto' position. This ensures the proper functioning of the motion detection capabilities while allowing you to make brightness adjustments as needed.

☆ By adjusting the brightness, you can address the following issues:

1. To enhance the contrast between full brightness and lower settings, you can reduce the low-level brightness.
2. Dimming can help mitigate flickering issues observed at low-level brightness in a few types of bulbs, ensuring a more stable and flicker-free lighting experience.

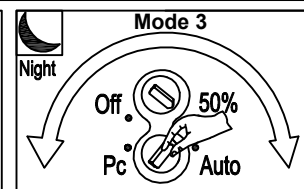

Dusk-to-Dawn Mode: In auto mode, you can switch to Dusk-to-Dawn mode by turning the lower dial from the 'Auto' position to the 'Pc' position. Once in this mode, the light will automatically turn on at dusk and remain fully illuminated until dawn. To switch back to the auto mode, rotate the lower dial from the 'Pc' position to the 'Auto' position.

IMPORTANT

- To ensure proper functionality of the brightness adjusting operation, it is highly recommended to use **DIMMABLE LED** bulbs, incandescent bulbs, or other types of dimmable bulbs. The low-level brightness function may not work effectively with non-dimmable bulbs.
- No matter in what mode, adjusting the upper dial will automatically trigger the **Dual-bright Test Mode** again. After the test mode (which lasts for 120 seconds), the light will return to the mode according to your previously selection. If you want to **skip the test mode**, you can do so by quickly turning the wall switch off and on within a 3-second interval.
- If turn the wall switch 'Off', wait over 10 seconds and then switch it 'ON' again, the light will revert to warm-up period again.
- To ensure proper operation of the above functions, it is important to keep the wall switch in the 'ON' position at all times, including during the daytime.

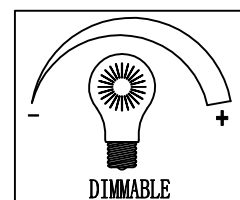

Troubleshooting

Symptom	Possible Cause	Solution
The light is not functioning in Test Mode.	The wall switch or circuit breaker is in the 'off' position.	Turn on the switch or circuit breaker.
	The wiring may be incorrect.	Check the wire connections for any issues.
	The bulb may be broken or incompatible.	Try replacing the current bulb with a different dimmable bulb.
In Dual-bright mode or ON/OFF mode, the lighting fixture does not turn on when motion is detected	The wall switch or circuit breaker is in the 'off' position.	Ensure power supply to the fixture by turning on the appropriate switch or circuit breaker.
	The light bulb may be burnt out.	Try testing the light bulb in a light fixture that you know is working properly.
	The Light bulb is loose.	Tighten the light bulb in its socket.
	There may be incorrect or loose wire connections.	Check the wire connections for any issues.
	Excessive sunlight is shining into the Dusk-to-Dawn sensor in the early evening.	Consider relocating the fixture away from a western-facing wall.
	Excessive light, perhaps from a nearby street lamp or another light fixture, is illuminating the Dusk-to-Dawn sensor.	Eliminate or turn off any other light sources, block any other light sources from shining onto the Dusk-to-Dawn sensor, or consider relocating the fixture.
In the Dual-bright mode or ON/OFF mode, the lighting fixture remains on at 100% brightness continuously.	False triggering may be caused by a heat source, such as traffic on the street or sidewalk, a heater or dryer vent, an air conditioning vent, or a heated swimming pool.	Eliminate any nearby heat sources or consider relocating the fixture.
In Dual-bright mode or ON/OFF mode, the lighting fixture turn on at 100% brightness unexpectedly.	False triggering may be caused by a heat source, such as traffic on the street or sidewalk, a heater or dryer vent, an air conditioning vent, or a heated swimming pool.	Eliminate any nearby heat sources or consider relocating the fixture.
The lighting fixture is experiencing undesired activation during daytime or premature operation in the early evening.	There may be obstructions or objects obstructing the sensor's view, as they may lead to inaccurate readings.	Remove any debris or obstacles that might interfere with the sensor's functionality, or consider relocating the fixture.
The LED bulb or fluorescent bulb may experience flickering when the lighting fixture is dimmed to the standby dimming level.	A non-dimmable bulb is installed in the lighting fixture.	Replacing the current bulb with dimmable LED bulbs, fluorescent bulbs, or incandescent bulbs specifically designed for dimming.
	Some dimmable LED bulbs or fluorescent bulbs may not be compatible or match properly with the lighting fixture.	<ol style="list-style-type: none"> 1. Rotate the upper dial on the sensor and choose an appropriate brightness level to match your dimmable bulb properly. 2. Try using bulbs from different manufacturers or models to see if the compatibility issue is resolved.
In Dual-bright mode, the standby brightness closely approximates the full brightness level.	Some dimmable LED bulbs or fluorescent bulbs may not be compatible or match properly with the lighting fixture.	Rotate the upper dial on the sensor and choose an appropriate brightness level to match your dimmable bulb properly.
In Dusk-to-Dawn mode, the light continues to remain illuminated even after dawn.	The ambient light level is insufficiently low.	Consider relocating the fixture to an area where it can receive an ample amount of ambient light.

IMPORTANT: If the issue persists, it is advisable to consult the user manual or contact customer support for further guidance.