

Assembly Instructions

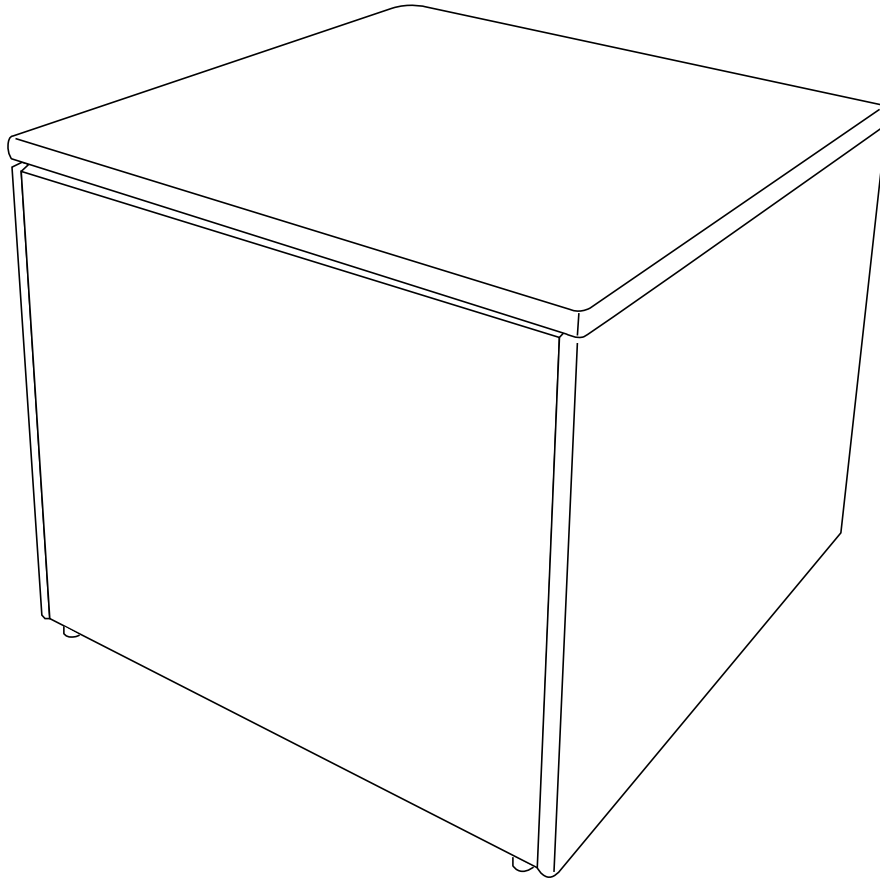









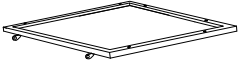

For any missing hardware, damaged parts and other problems.
WELCOME to email us at: service@behousewell.com

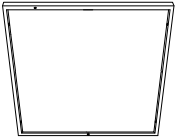
Or call at 1-888-733-8169 Toll free
Between 9AM and 5PM Eastern time, Monday through Friday

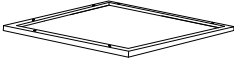
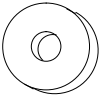
***Don't fully tighten all the bolts till the very end!**

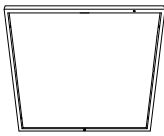
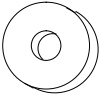
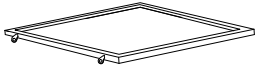
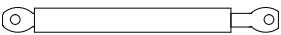

PRE-ASSEMBLY PREPARATION:

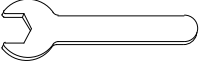
- Please read through the instructions before beginning assembly.
- Clear out the space for assembly and lay out all of the parts based on the Parts List, extra room will allow you to easily determine if all the pieces are present.
- Keep small parts and pieces away from children until fully assembled.

Part no.	Part	QTY	Image	Part no.	Part	QTY	Image
A	Back panel	1		I	Washer Ø16*Ø6.5*1mm	18	
B	Left panel	1		J	Bolt (M6*25mm)	6	
C	Front panel	1		K	Plastic gasket Ø16*Ø6.5*2mm	2	
D	Bottom panel	1		L	Nut	2	
E	Right panel	1		M	Plastic gasket Ø16*Ø6.5*10mm	4	
F	Top panel	1		N	Gas Pump	2	
G	Waterproof bag	1		O	Allen wrench	1	
H	Bolt (M6*30mm)	14		P	Wrench	1	

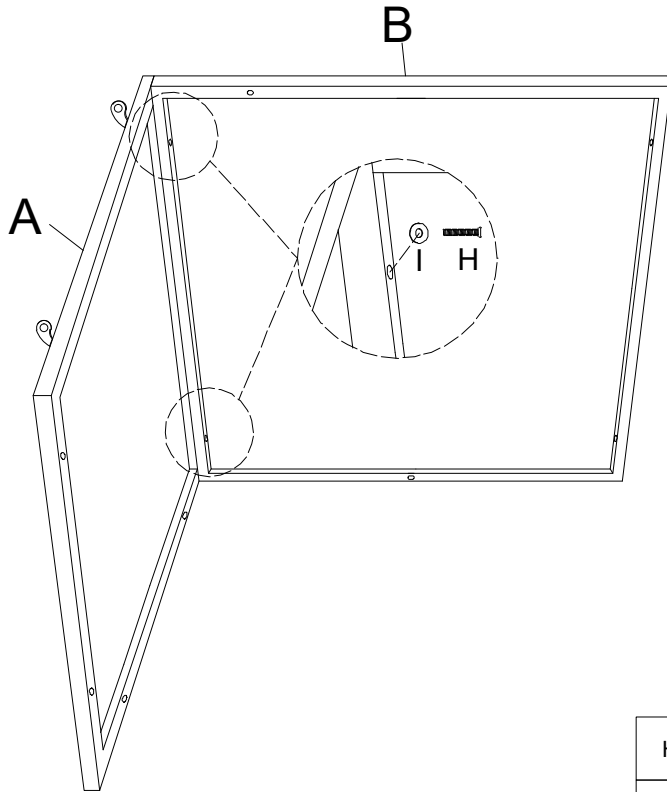

Step 1: Attach back panel A to side panel B with 2pcs bolts H and 2pcs washers I, using Allen wrench O. Note: Don't fully tighten the bolts.



H		M6*30	2
I		M6	2

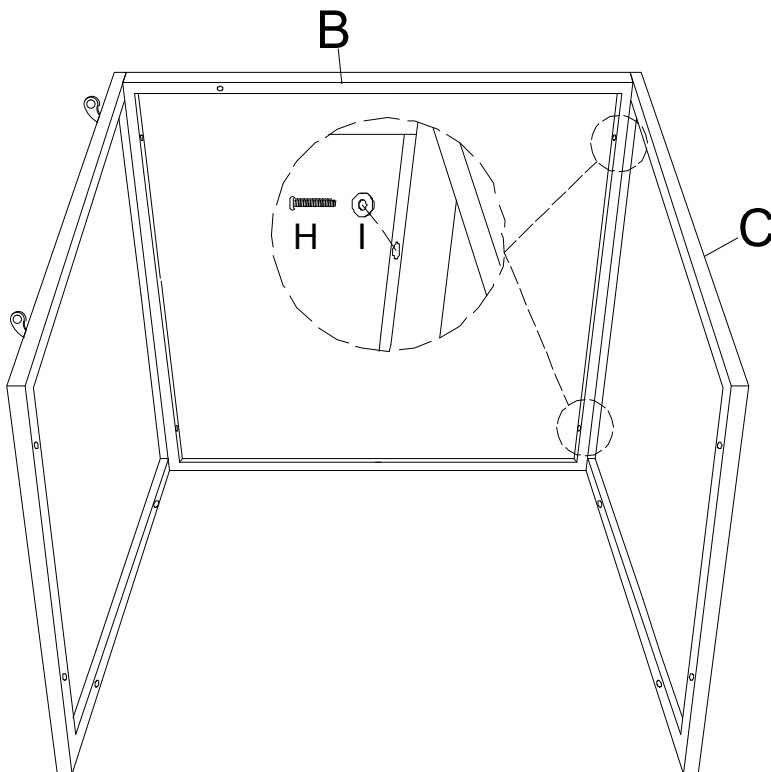

Step 2: Attach front panel C to left panel B with 2pcs bolts H and 2pcs washers I, using Allen wrench O. Note: Don't fully tighten the bolts.



H		M6*30	2
I		M6	2

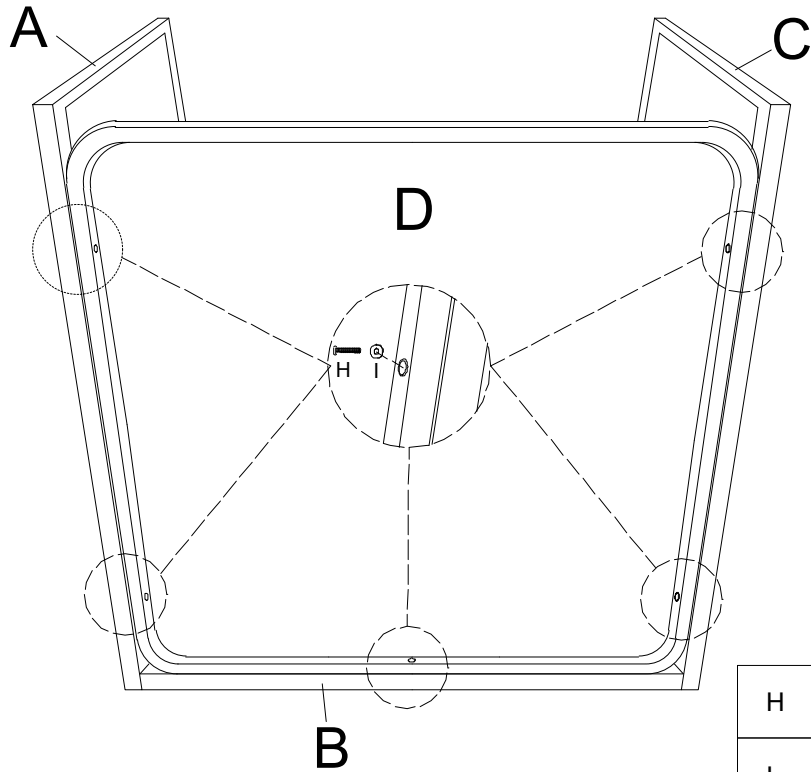

Step 3: Attach bottom panel D to part A & B & C with 5pcs bolts H and 5pcs washers I, using Allen wrench O. Note: Don't fully tighten the bolts.



H		M6*30	5
I		M6	5

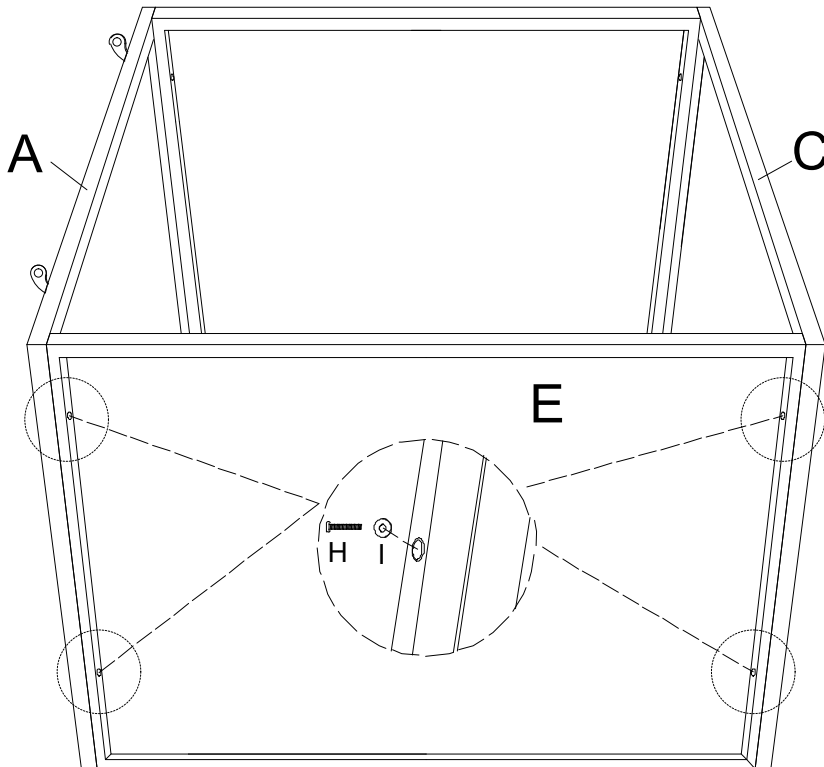

Step 4: Attach right panel E to part A & C with 4pcs bolts H and 4pcs washers I, using Allen wrench O. Note: Don't fully tighten the bolts.



H		M6*30	4
I		M6	4

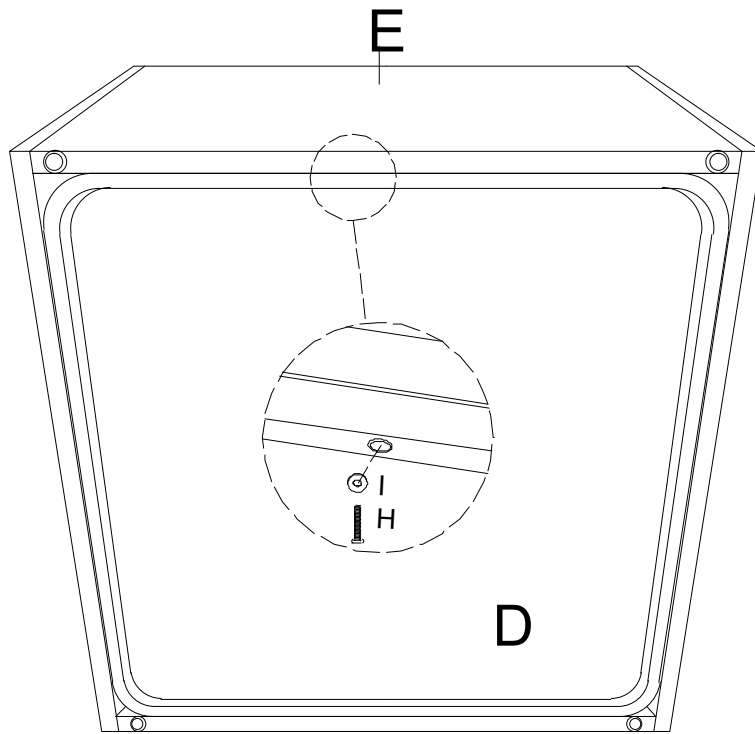



Step 5: Attach right panel E to bottom panel D with 1pc bolt H and 1pc washer I, using Allen wrench O. Note: Don't fully tighten the bolts.

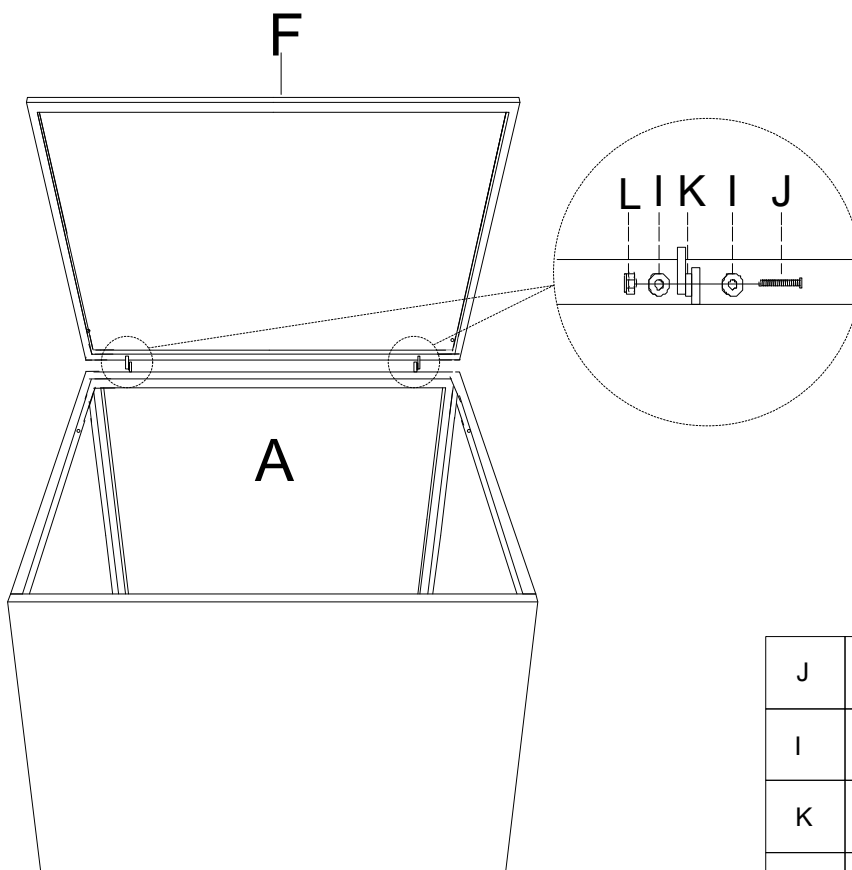

H		M6*30	1
I		M6	1

Step 6: Attach top panel F to back panel A with 2pcs bolts J, 4pcs washers I, 2pcs plastic gasket K, and 2pcs nuts L, using Allen wrench O and wrench P. Note: Don't fully tighten the bolts.



J		M6*25	2
I		M6	4
K		plastic gasket Ø16*Ø6.5*2	2
L		M6	2

Step 7: Attach 2pcs gas pump N to panel B & E & F with 4pcs bolts J and 4pcs plastic gasket M, using Allen wrench O and wrench P. Note: Please fully tighten all the bolts.

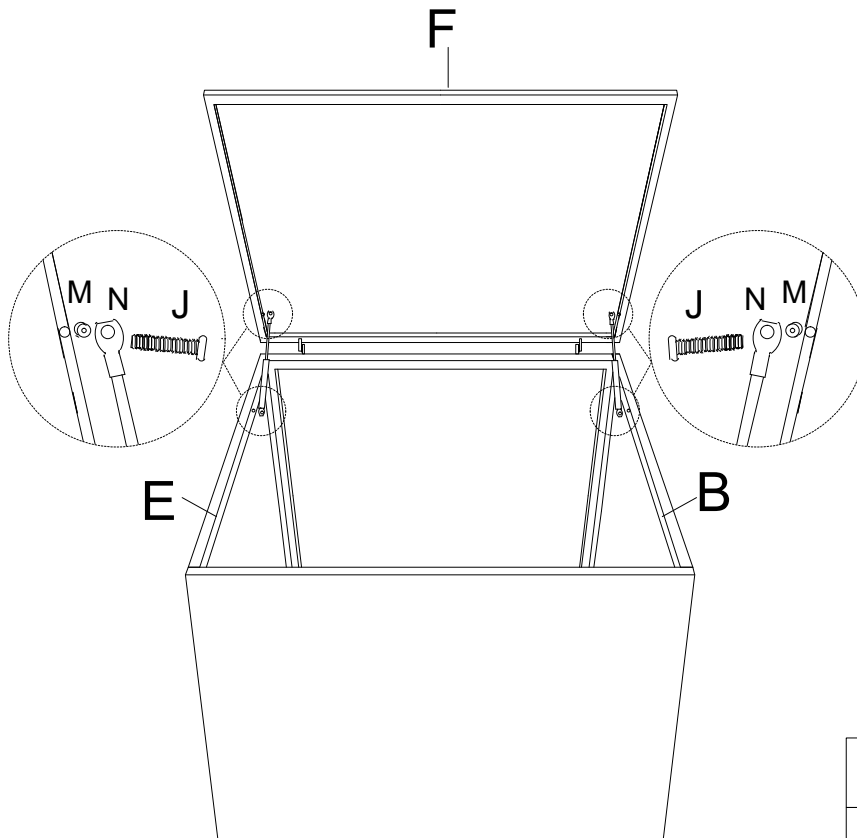

J		M6*25	4
M		plastic gasket Ø16*Ø6.5*10	4

Step 8: Attach waterproof bag G to the upper edge of box by sticker Velcro.

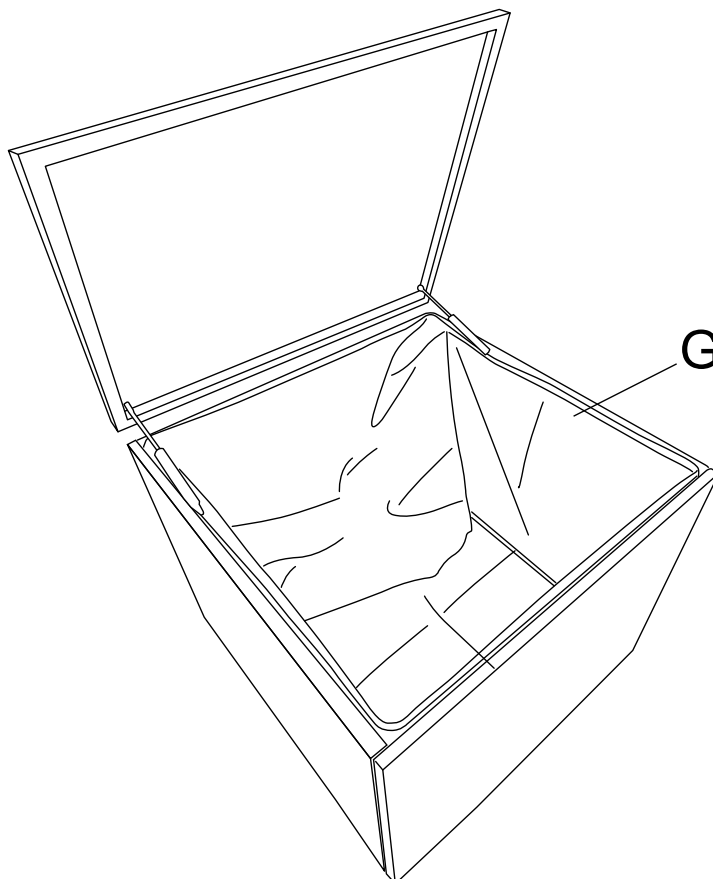

Step 9: Assembly is now complete and the product is ready for use.

