

# BUNK BED ASSEMBLY INSTRUCTIONS

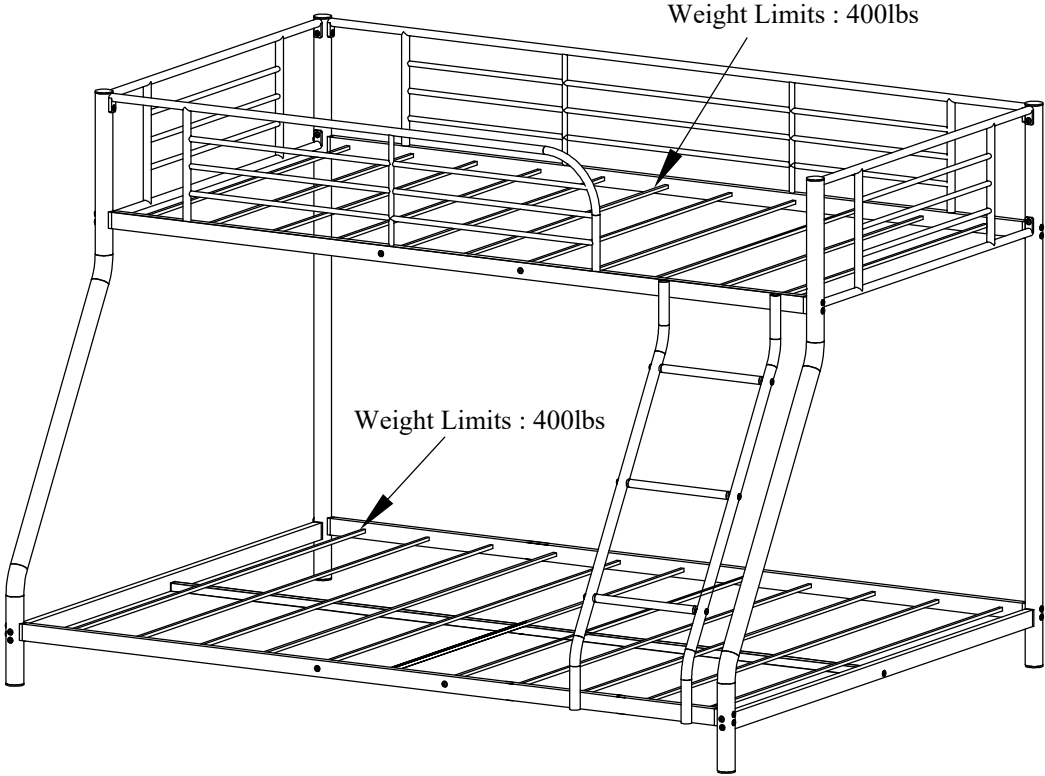

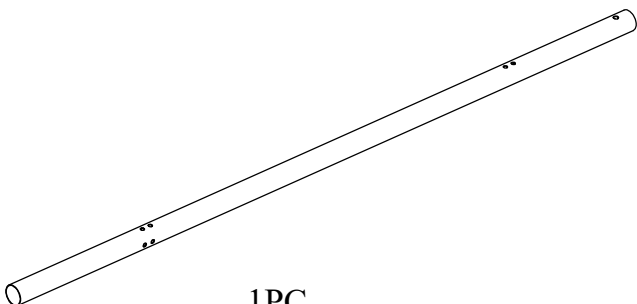

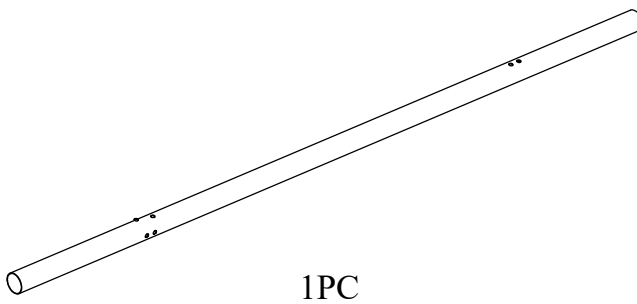
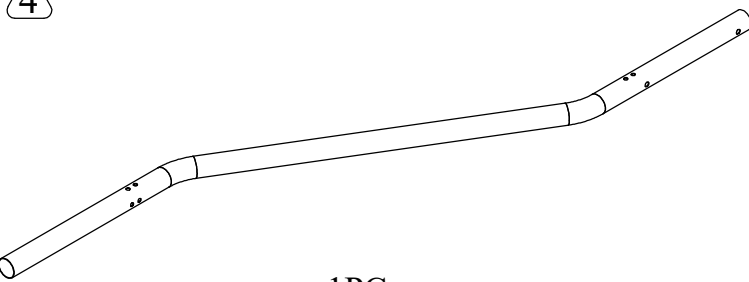
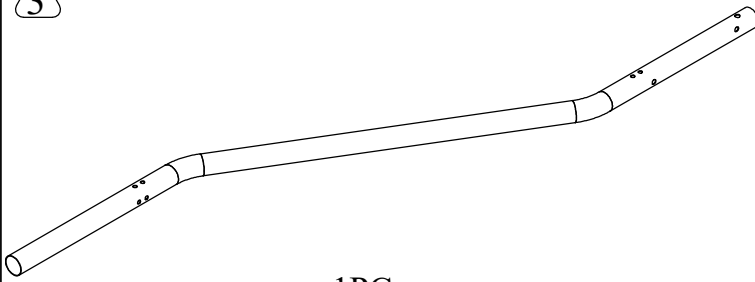
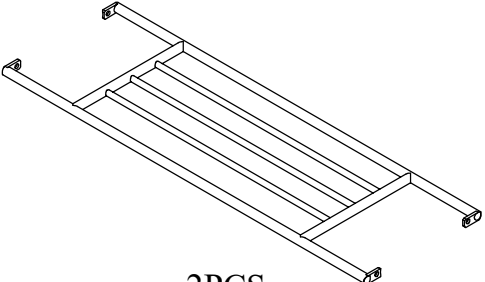
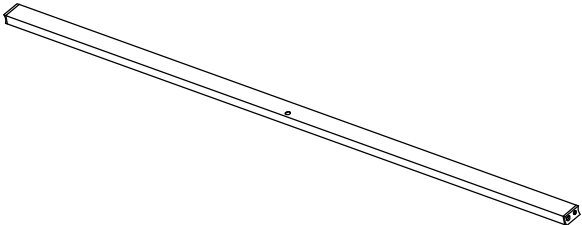

## PART LIST

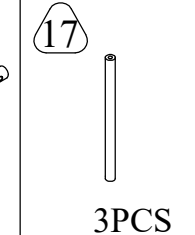
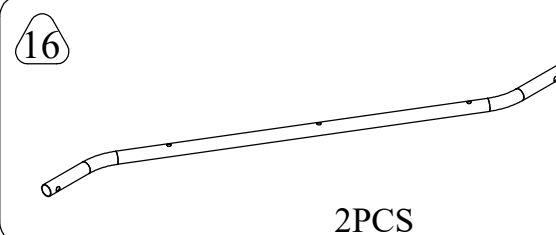
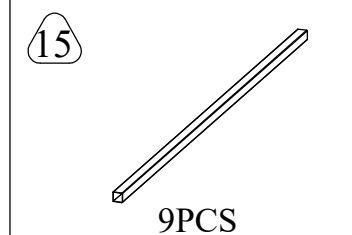
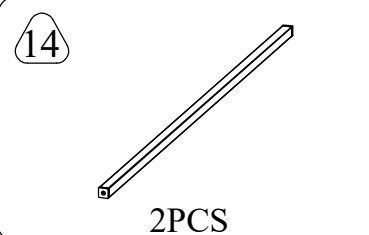
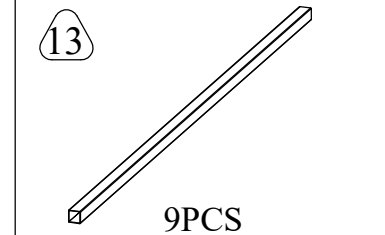
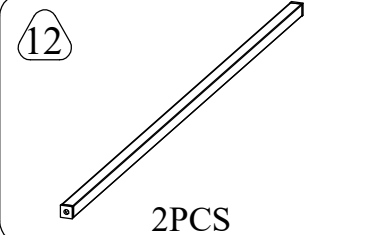
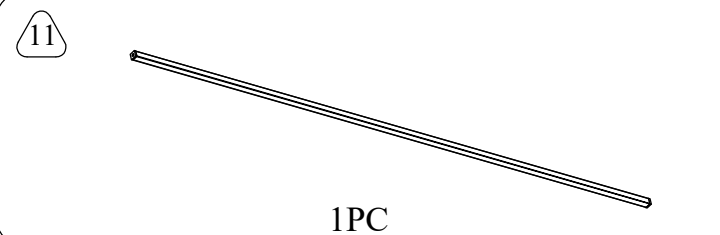
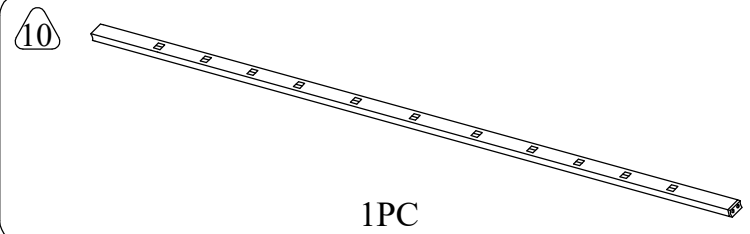
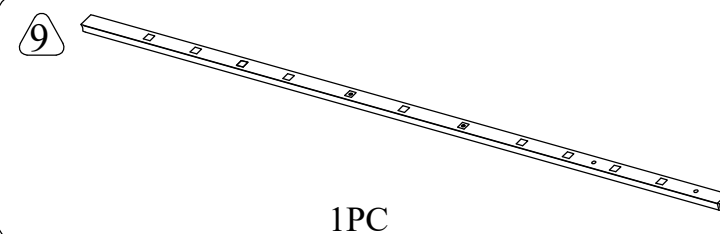
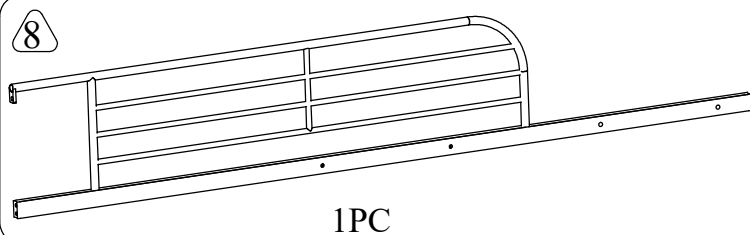
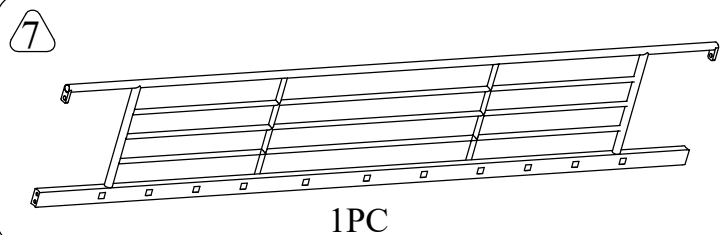
<p>1</p>  <p>1PC</p>	<p>2</p>  <p>1PC</p>
<p>4</p>  <p>1PC</p>	<p>3</p>  <p>1PC</p>
<p>5</p>  <p>2PCS</p>	<p>6</p>  <p>2PCS</p>

# BUNK BED ASSEMBLY INSTRUCTIONS

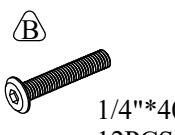

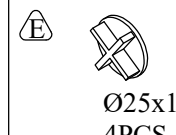
## HARDWARE LIST

 <b>A</b> 1/4"*60 24PCS	 <b>B</b> 1/4"*40 12PCS	 <b>C</b> 1/4"*15 19PCS	 <b>D</b> Ø42x10 8PCS	 <b>E</b> Ø25x10 4PCS	 <b>F</b> 4x60 2PCS
---	---	---	---	--	---

### IMPORTANT SAFETY NOTICE: READ CAREFULLY BEFORE BEGINNING ASSEMBLY!

- ⚠ Keep desiccant, hardware packs and small components away from children, avoid eating and injuring.
- ⚠ Please do follow assembly steps.
- ⚠ Please do not lock any screws before each assembling unit is well placed in appropriate position.
- ⚠ Please do make sure all components are firmly locked after assembly and before use to avoid any potential safety hazard.
- ⚠ Please do use product correctly by it's origin purpose to avoid any danger happened.
- ⚠ Please do not stand on any part of components, except the ladder of this product after complete assembly.
- ⚠ If product is required to lock on the wall, please do so in case of any safety hazard happened before use.
- ⚠ Please check all contents of this product inside the carton (s) carefully, small parts may lost during shipment, if any of this happened, please contact the retailer from who you purchased this product to obtain replacement, do not use any substitute items.
- ⚠ This assembly instructions booklet contains important safety information, please read carefully before assembly and keep for further reference.
- ⚠ This products is designed referring to overall loading of each set final product, Please avoid to load on single point of final product making damaged  
 product name : BUNK BED (item 127) overall loading: 400 LBS (maximum)  
 product name : BUNK BED (item 127) overall loading: 400 LBS (maximum)

# BUNK BED ASSEMBLY INSTRUCTIONS

## STEP 1

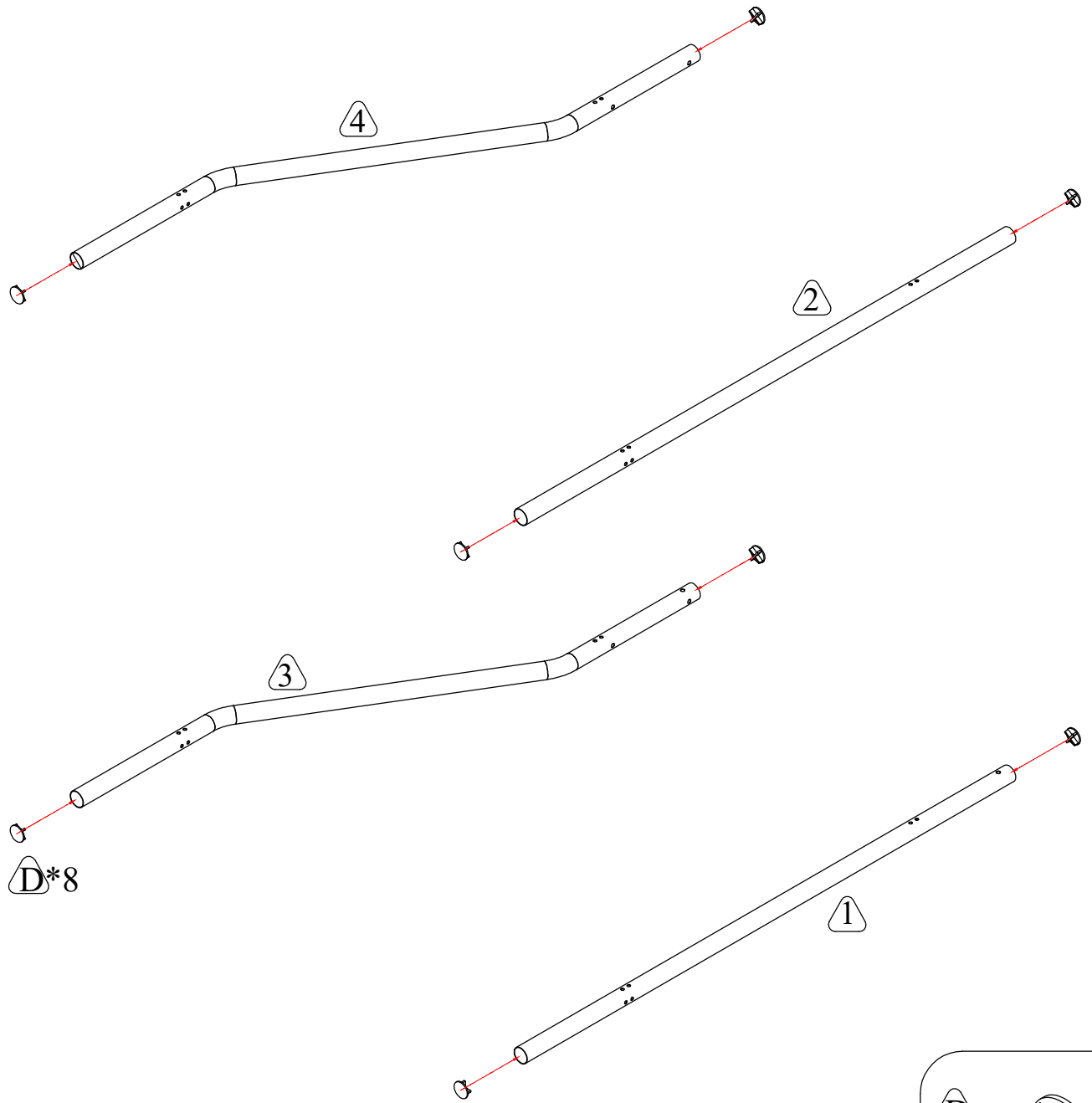

# BUNK BED ASSEMBLY INSTRUCTIONS

## STEP 2

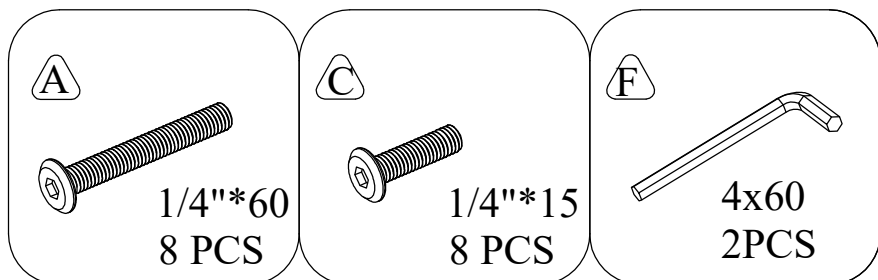
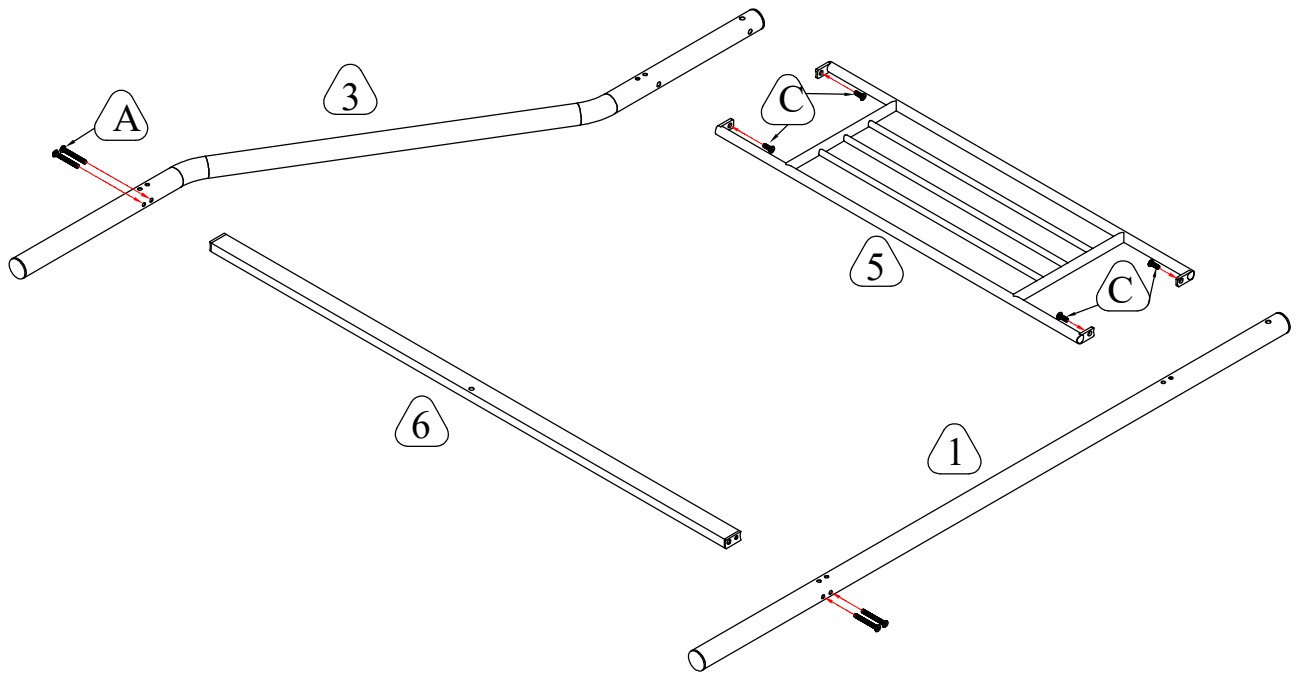
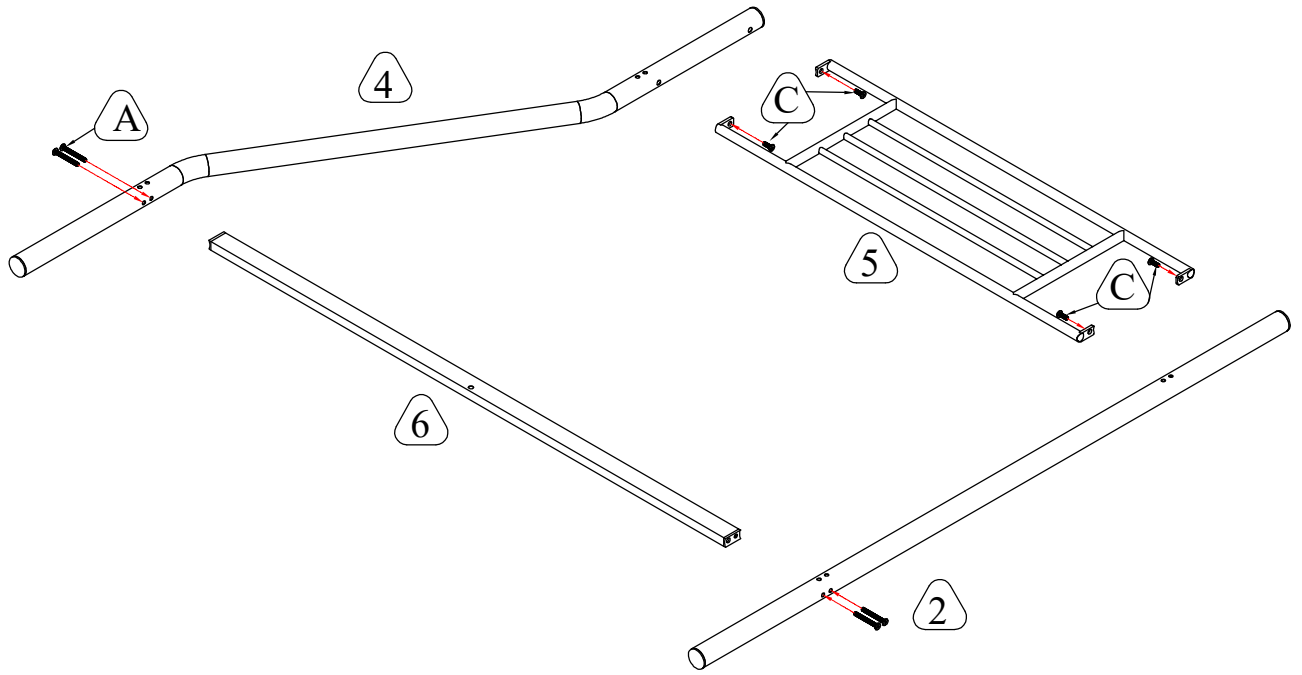

# BUNK BED ASSEMBLY INSTRUCTIONS

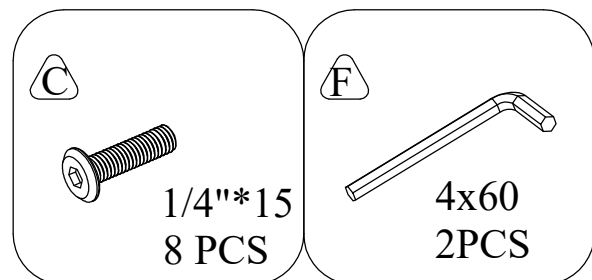
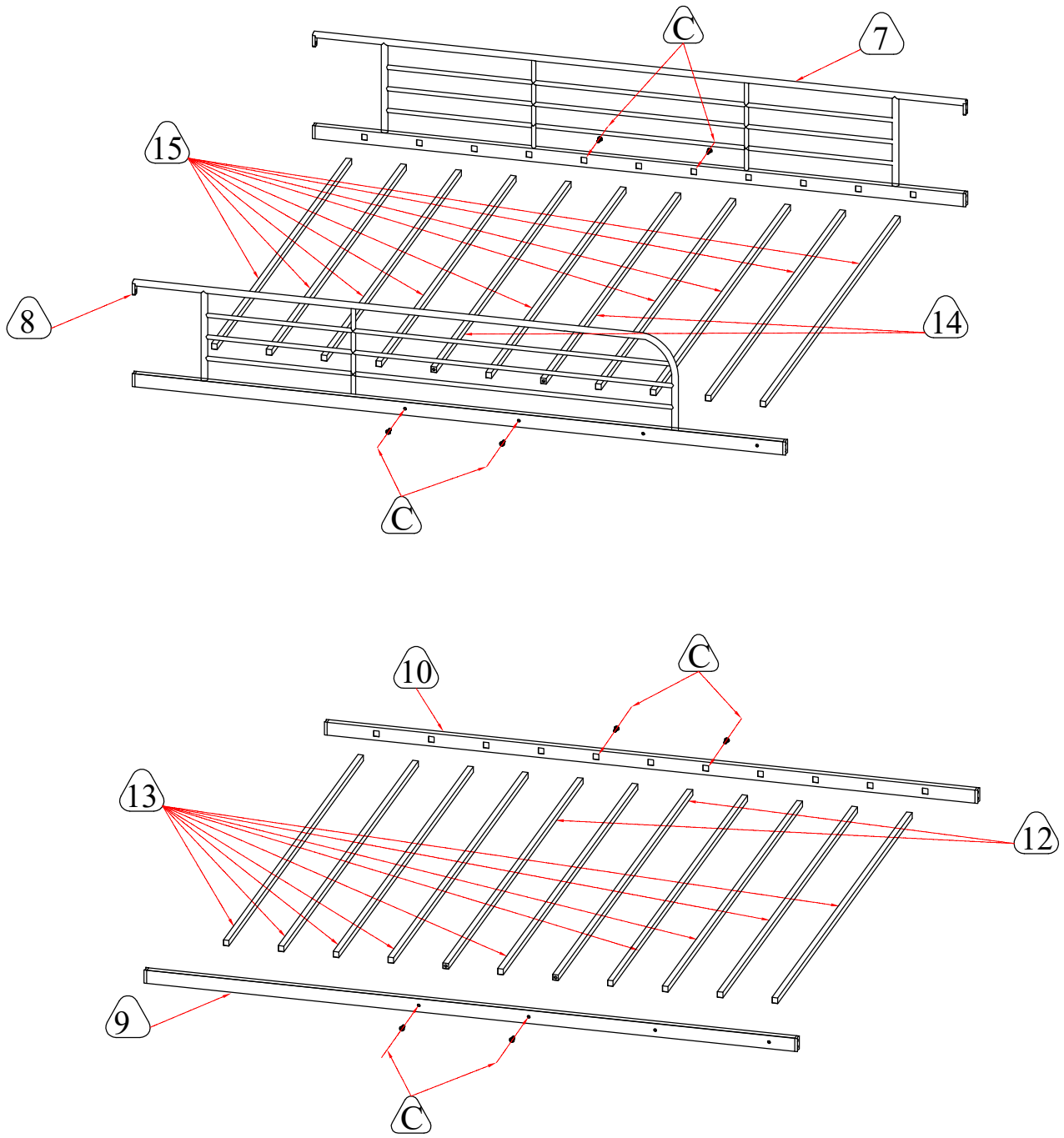

## STEP 3



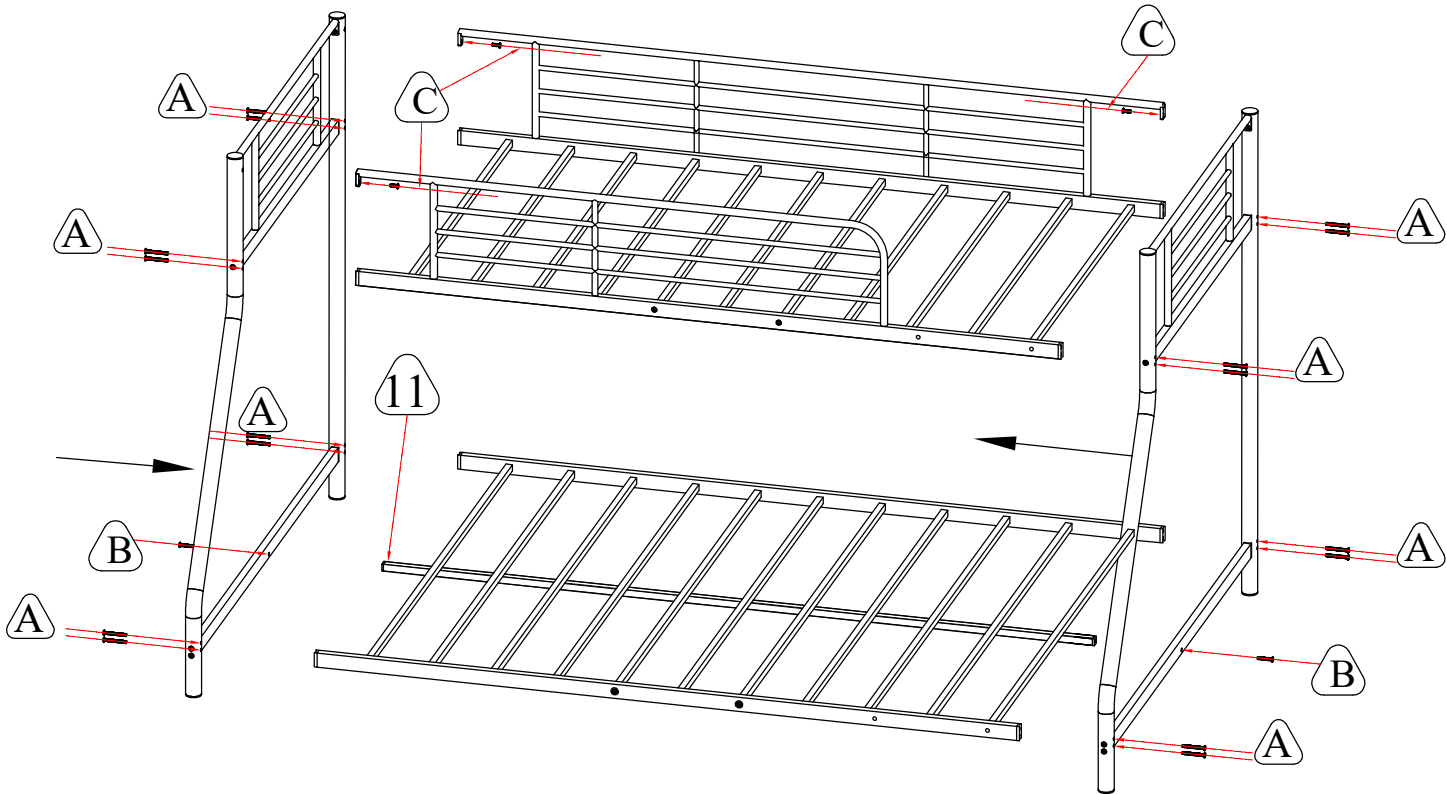

# BUNK BED ASSEMBLY INSTRUCTIONS

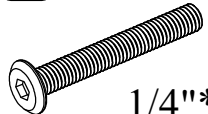
## STEP 4 =STEP 2+STEP 3

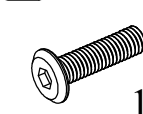

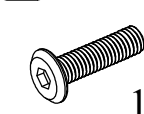
 	 
<b>A</b> 1/4"*60 16 PCS	<b>B</b> 1/4"*40 2 PCS

 	
<b>C</b> 1/4"*15 3 PCS	<b>F</b> 4x60 2PCS

# BUNK BED ASSEMBLY INSTRUCTIONS

## STEP 5

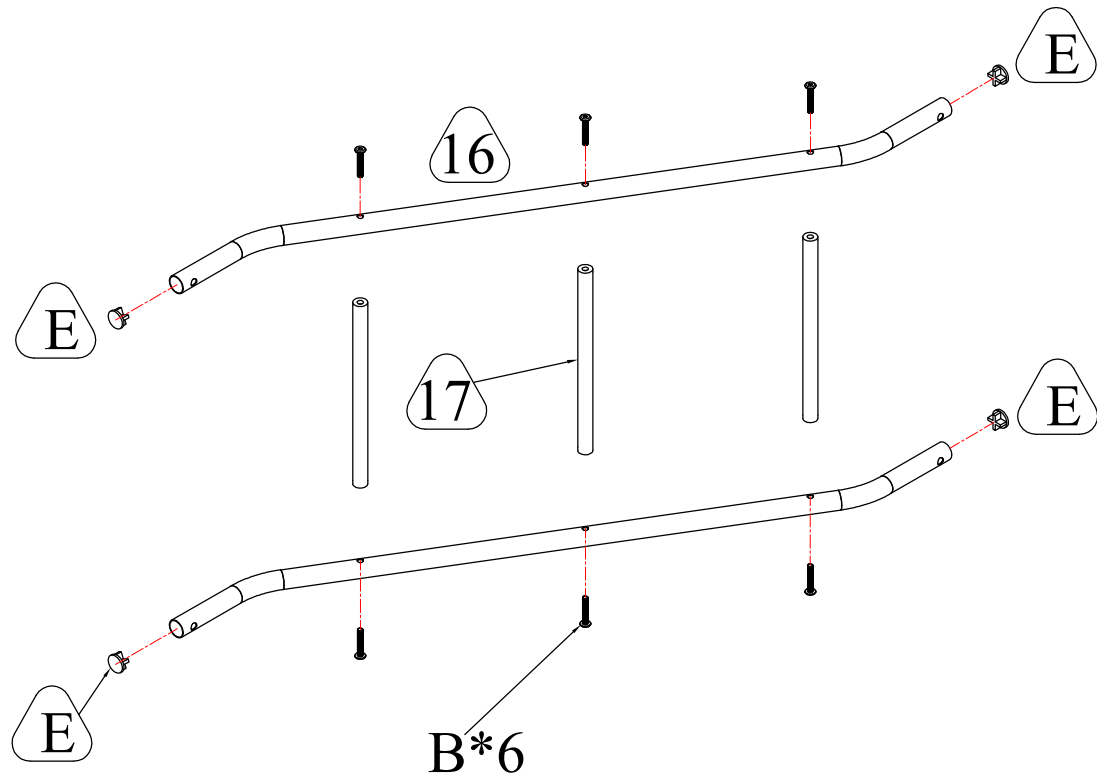

**E**



Ø25x10  
4PCS

**B**

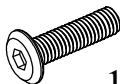

1/4"\*40  
6 PCS

**F**



4x60  
2PCS

BUNK BED  
ASSEMBLY INSTRUCTIONS

STEP 6=STEP 4+STEP 5

