

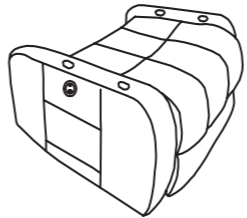

Electric Lift Chair Assembly Instruction

			
Chair base	Backrest	Remote control	Power cord
			
Remote control	Power source	Armpad	Connect button

STEP1

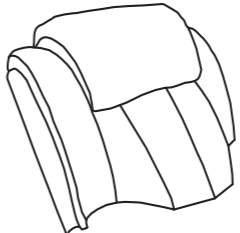
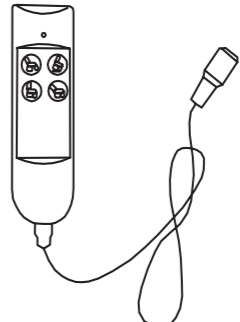

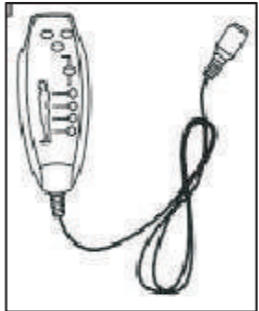
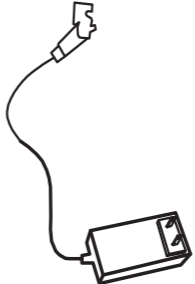
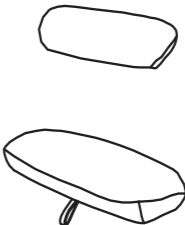
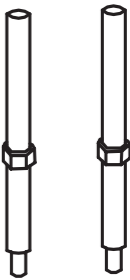
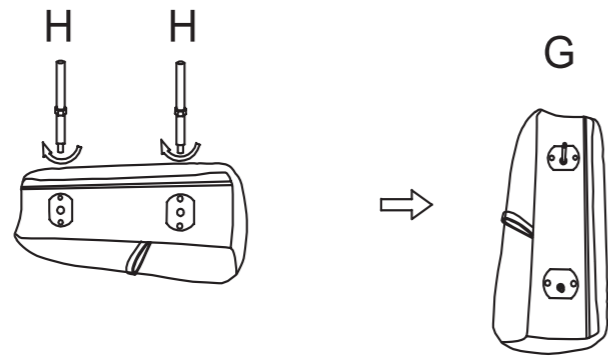
STEP2

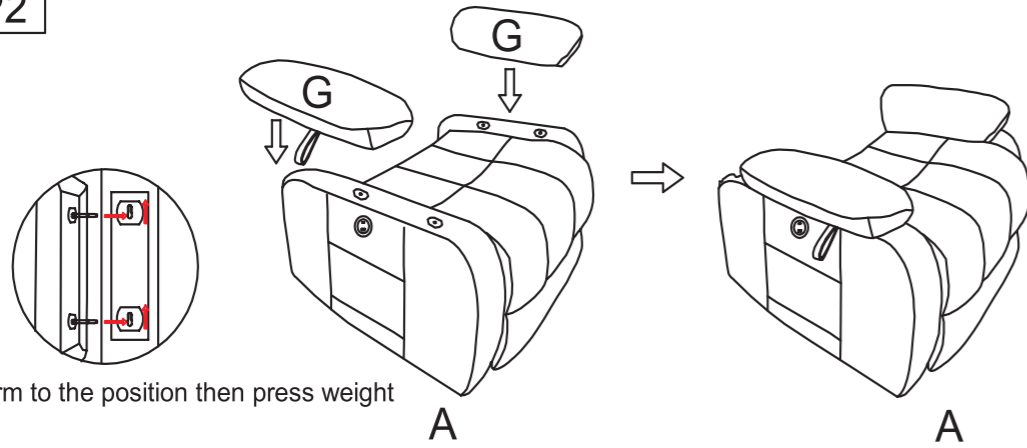

STEP3

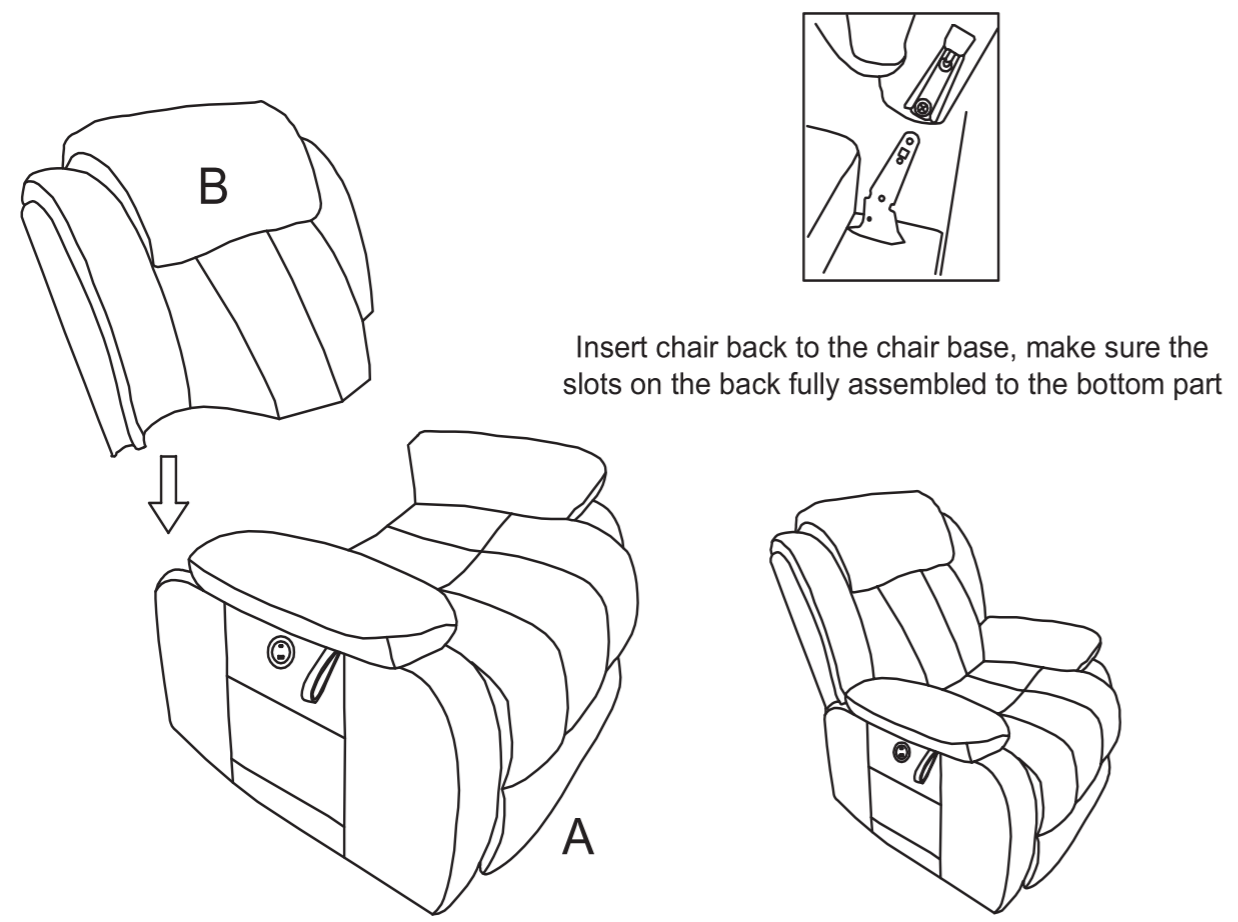

Electric Lift Chair Assembly Instruction

How to use remote control?

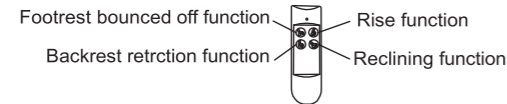

How to use remote control?

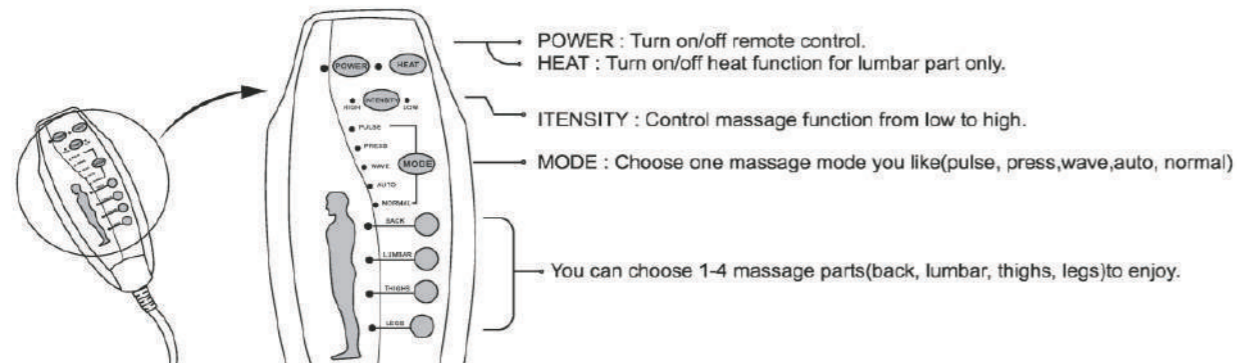

How to use control panel that outside of right armrest?

Control panel is for chair lift and reclining function, also has dual USB outlets(5V2A+Type C) that keep your devices charging, such as nearly all smartphone(like iPhone, Samsung..),ipad, headphnes,Kindle..

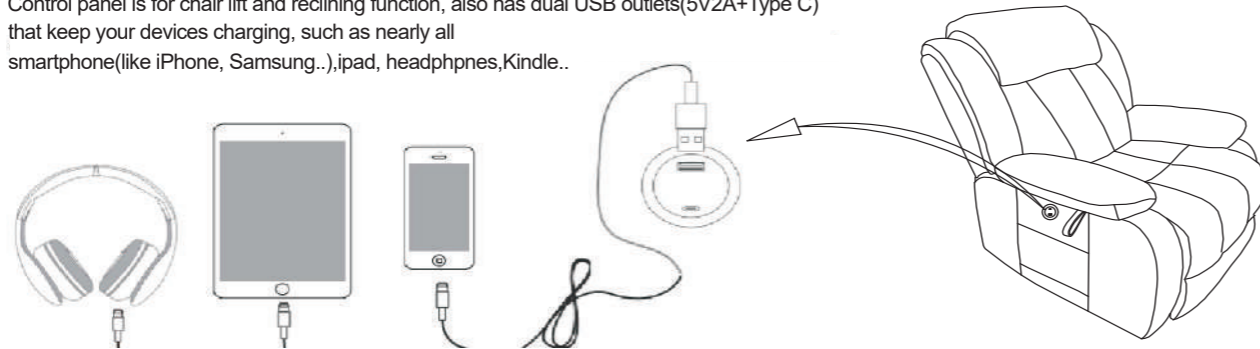

Electric Lift Chair Assembly Instruction

STEP4

- No.1 and No.2 wire connect with the backrest and chair base.
- No.3 wire connects with backrest and power cord(D).
- No.4 wire connects with backrest and remote control(E).
- No.5 wire connect the motor and the wire from rightside armrest, which use to connect the control panel.
- No.6 wire connect the motor and power source(F).
- No.7 power cord for USD & Type-c

NOTE

- 1: Two same color wires connect.
- 2: Plug power cord and power source into outlet, then you can use all function.

Electric Lift Chair Assembly Instruction

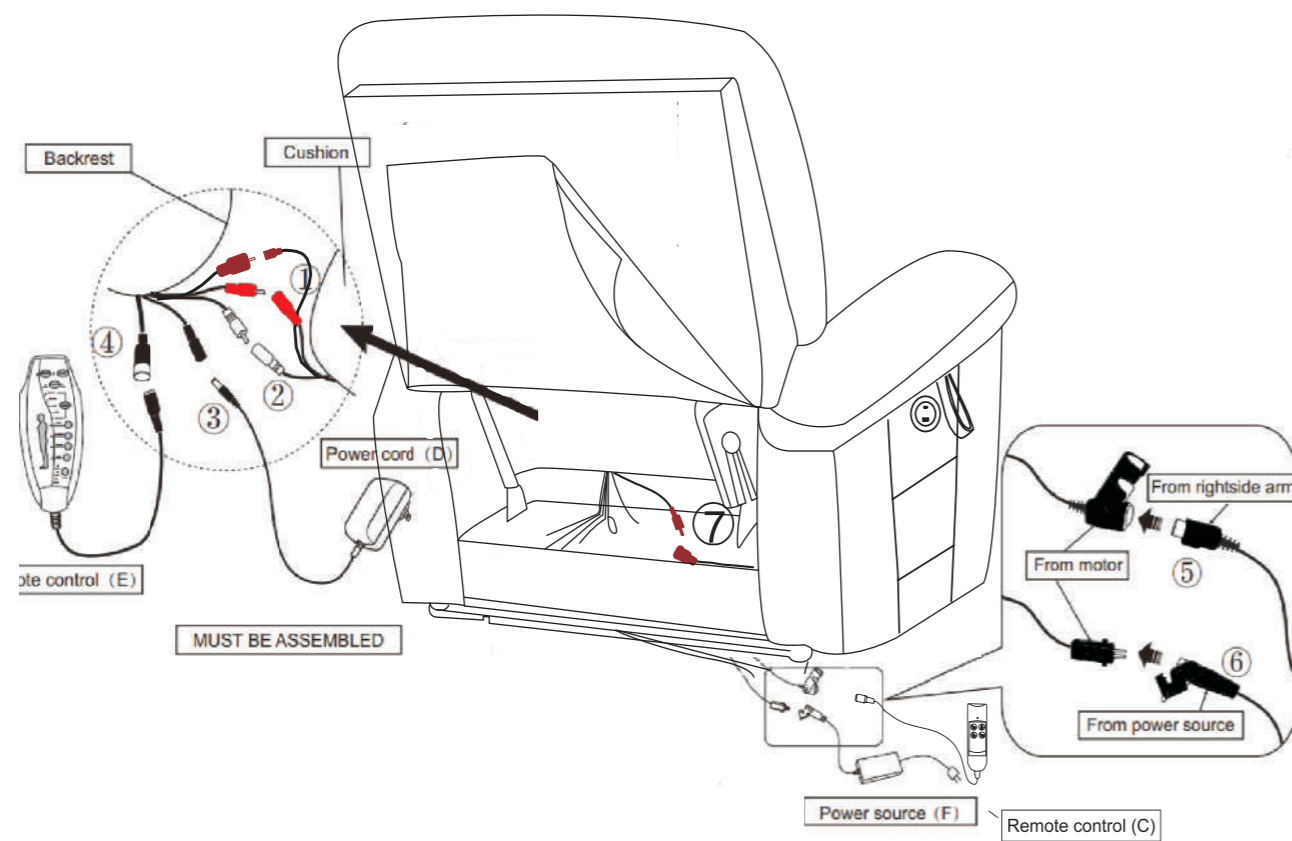

Electric Lift Chair Assembly Instruction

