

WARNING

- * Switch off the main electrical supply from the main fuse box / circuit breaker before installation.
- * Inspect item carefully before attempting to install.
- * If there is any damages or obvious defects, do not install.
- * Item may not be returned once it has been installed.











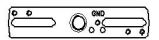

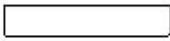
CARE AND MAINTENANCE

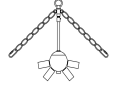
- * To clean the outside of the fixture, use a dry or slightly dampened clean cloth (use clean water, never a solvent) to wipe the surface of the fixture.
- * To clean the inside of the fixture, first disconnect power to the fixture by turning off the circuit breaker or by removing the fuse at the fuse box. Next, use a dry or slightly dampened clean cloth (use clean water, never a solvent) to wipe the interior surface of the fixture.
- * Do not use any cleaners with chemical, solvents or harsh abrasives. Use only a dry soft cloth to dust or wipe

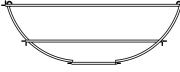
NOTICE & IMPORTANT SAFETY INSTRUCTIONS

- ** WE RECOMMEND INSTALLATION OF THIS LIGHTING FIXTURE BE DONE BY A LICENSED ELECTRICIAN **
- * Please make sure that you have all parts indicated before you begin assembly of this item
- * This item should be assembled on a soft surface to prevent scratching the finish during assembly
- * To reduce the risk of fire, electrical shock or injury to persons or property, please follow the guideline below for safe use and installation
- *The external flexible cable or cord of this lamp cannot be replaced
If the cord is damaged, the lamp shall be destroyed

Part List and Hardware List

PIECE	DESCRIPTION	PICTURE	QUANTITY	PIECE	DESCRIPTION	PICTURE	QUANTITY
A	Mounting Plate		1X	H	Mounting Screw		2X
B	Canopy		1X	I	Ground Screw		1X
C	Hanging Loop		1X	J	Lamp Body		1X
D	Canopy Nut		1X	K	Frame		1X
E	Chain		1X	L	Small Glass		24X
F	Closable Link		6X	M	Big Glass		15X
G	Wire Nut		3X	N	Bulb		9X

SAFAVIEH

C O U T U R E

Model#: CTL1090

Product Dimensions: 29"L X 29"W X 26-85"H

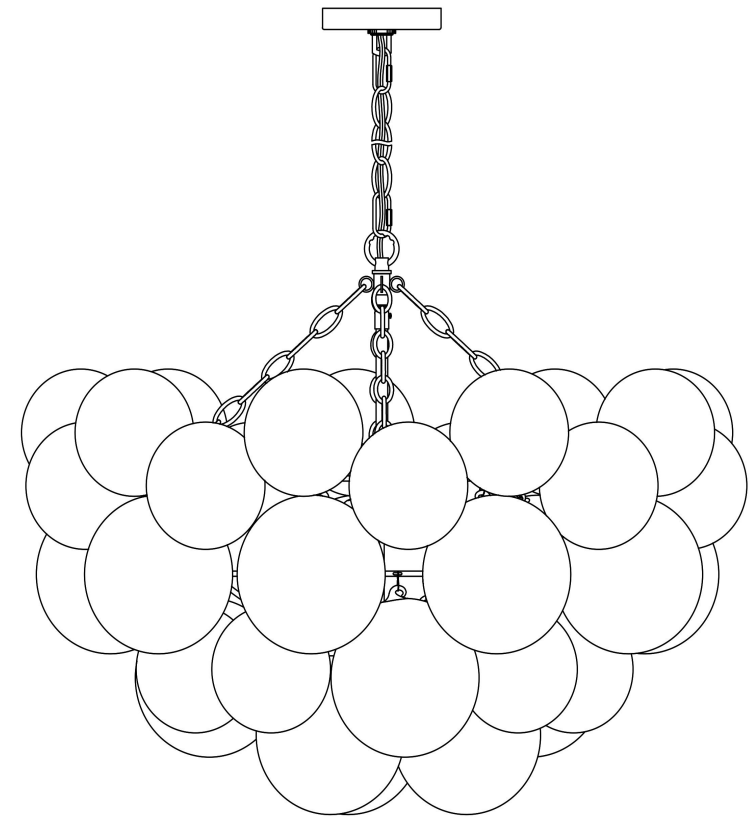

PREPARATION

- * Before beginning assembly of product, make sure all parts are present. Compare parts with package contents list and hardware contents list.
- * If any part is missing or damaged, do not attempt to assemble the product.
- * Estimated Assembly Time: 30 minutes.
- * Tools Required for Assembly (not included): Screwdriver, Junction box
- * If you are having difficulty, our friendly Customer Care team is always here to help. Please email customersupport@safavieh.com

NOTE: PLEASE USE DIMMABLE TYPE "B" BULB MAX 25-WATT OR LED BULB MAX 5-WATT THERE ARE 9PCS LED 4-WATT BULB IN THE BOX

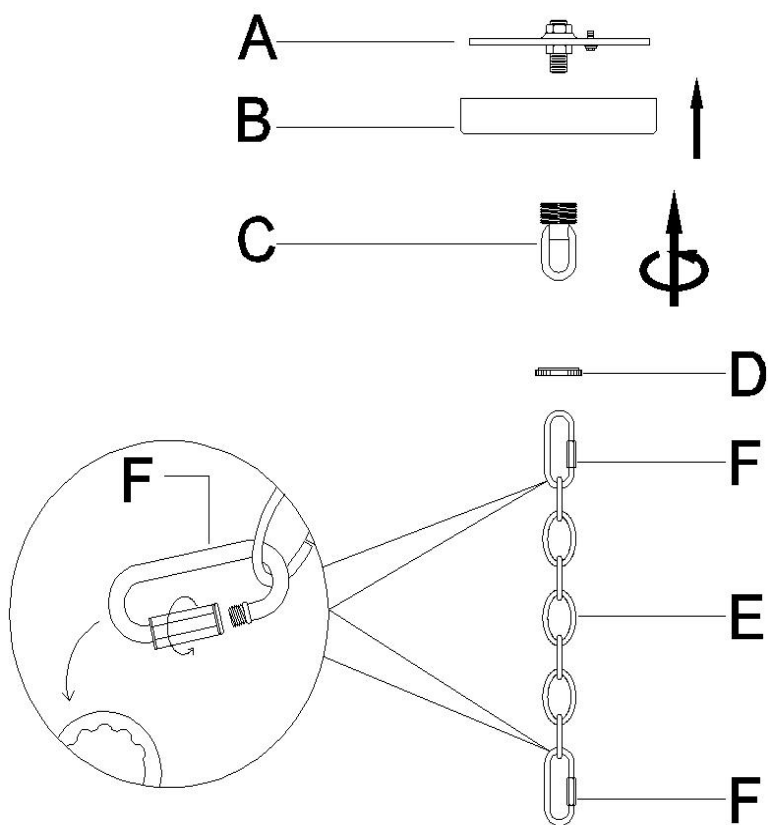

Step 1: Unpack all parts from cartons carefully. Place the Canopy(B) onto the Hanging Loop(C) Place the tube of Mounting Plate(A) into the threaded portion of the Hanging Loop(C) and fix it by turning the Canopy Nut(D) clockwise till tight. Attach the Closable Link(F) onto the Hanging Loop(C)

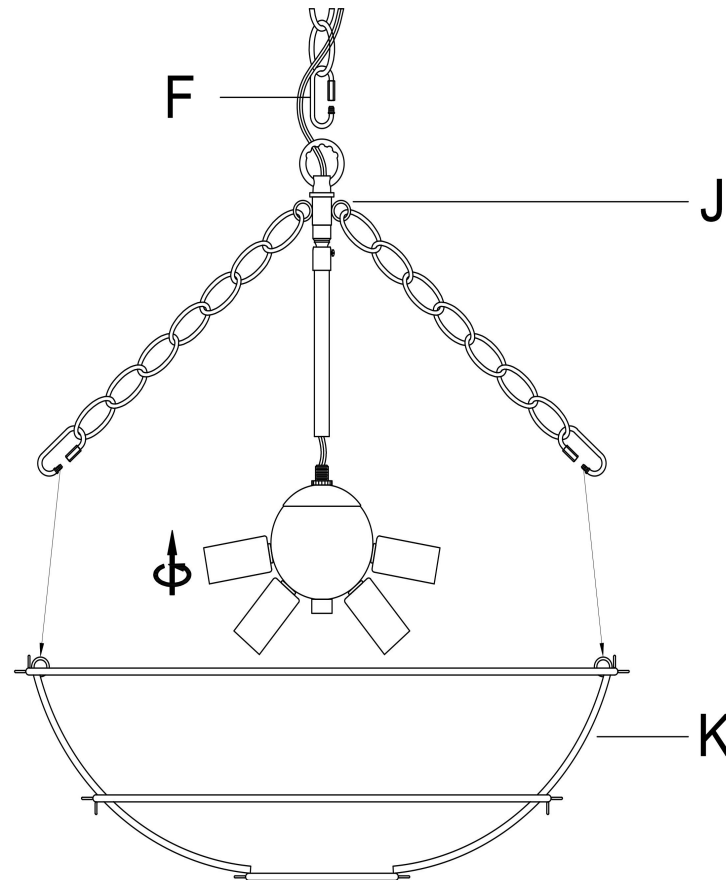

Step 2: Rotate clockwise to fix the ball on the Lamp Body (J) to the center rod, Fix the four open chain links on the Lamp Body (J) to the small ring on the Frame (K) in turn, and then fix the open chain link at one end of the chain to the hanging ring on the Lamp Body (J)

PREPARATION

- * Before beginning assembly of product, make sure all parts are present. Compare parts with package contents list and hardware contents list.
- * If any part is missing or damaged, do not attempt to assemble the product.
- * Estimated Assembly Time: 30 minutes.
- * Tools Required for Assembly (not included): Screwdriver, Junction box
- * If you are having difficulty, our friendly Customer Care team is always here to help. Please email customersupport@safavieh.com

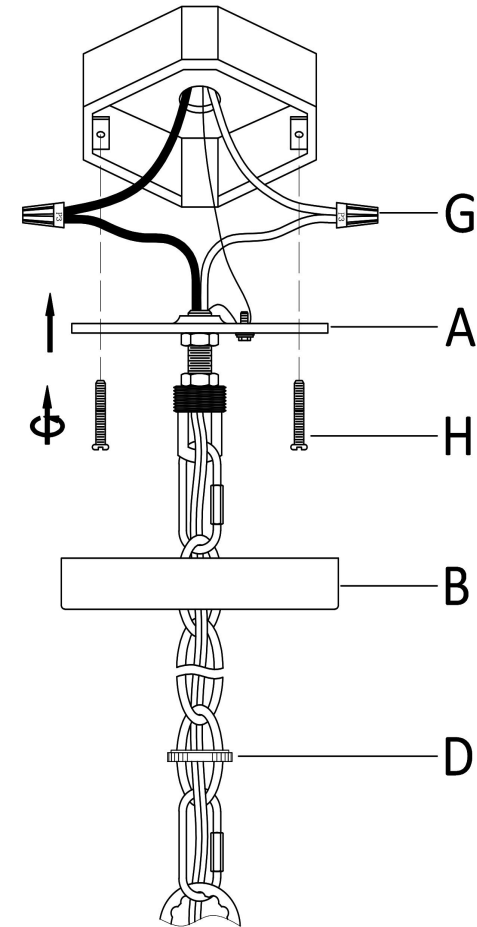
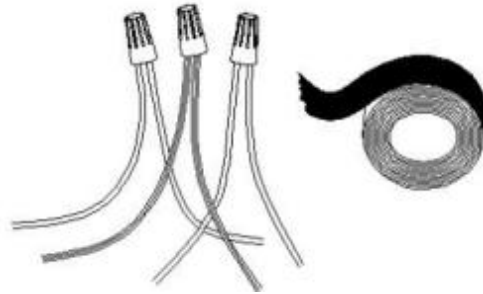
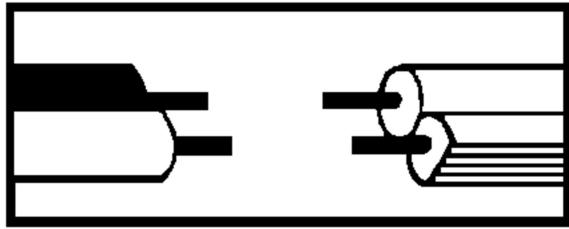

Step 3: Wire connection

Connect fixture neutral wire (ribbed) to the outlet box neutral wire (usually white) using a wire nut. Connect fixture hot wire (smooth with markings) to the outlet box hot wire (usually black) using a wire nut. CAUTION: Do not reverse the hot and neutral connections

Grounding Instructions:

Wrap ground wire from outlet box around green ground screw on mounting Plate (A), no less than 2" from wire end. Tighten ground screw. If fixture is supplied with a ground wire, connect to outlet ground wire with a wire connector.

Step 4: Fasten the Mounting Plate (A) to the junction box by turning the Mounting Screw (H) clockwise

PREPARATION

- * Before beginning assembly of product, make sure all parts are present. Compare parts with package contents list and hardware contents list.
- * If any part is missing or damaged, do not attempt to assemble the product.
- * Estimated Assembly Time: 30 minutes.
- * Tools Required for Assembly (not included): Screwdriver, Junction box
- * If you are having difficulty, our friendly Customer Care team is always here to help. Please email customersupport@safavieh.com

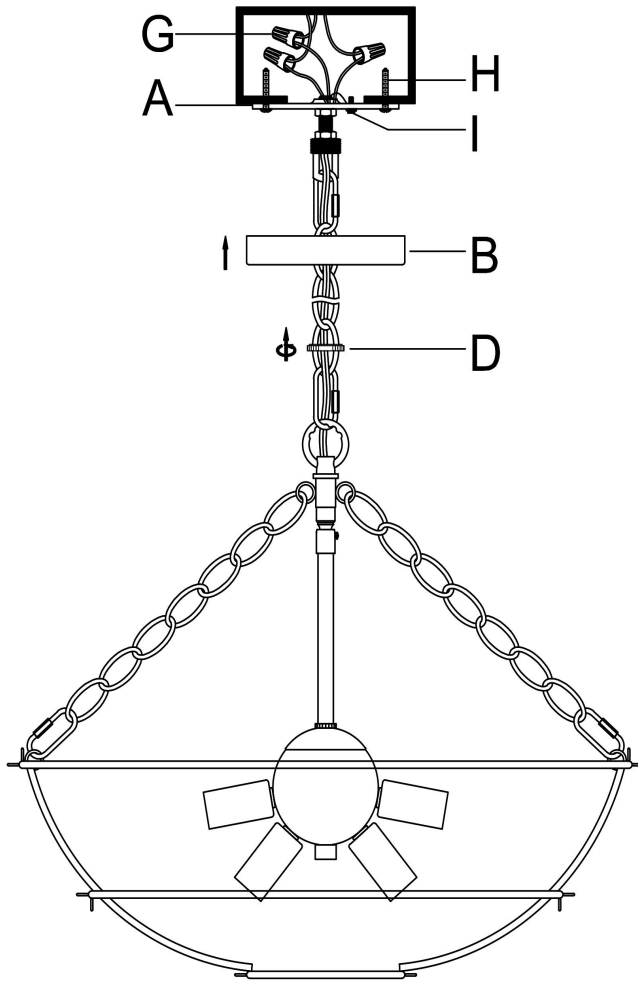

Step 5: Fasten the Canopy (B) to the Mounting Plate (A) by turning the Canopy Nut (D) clockwise

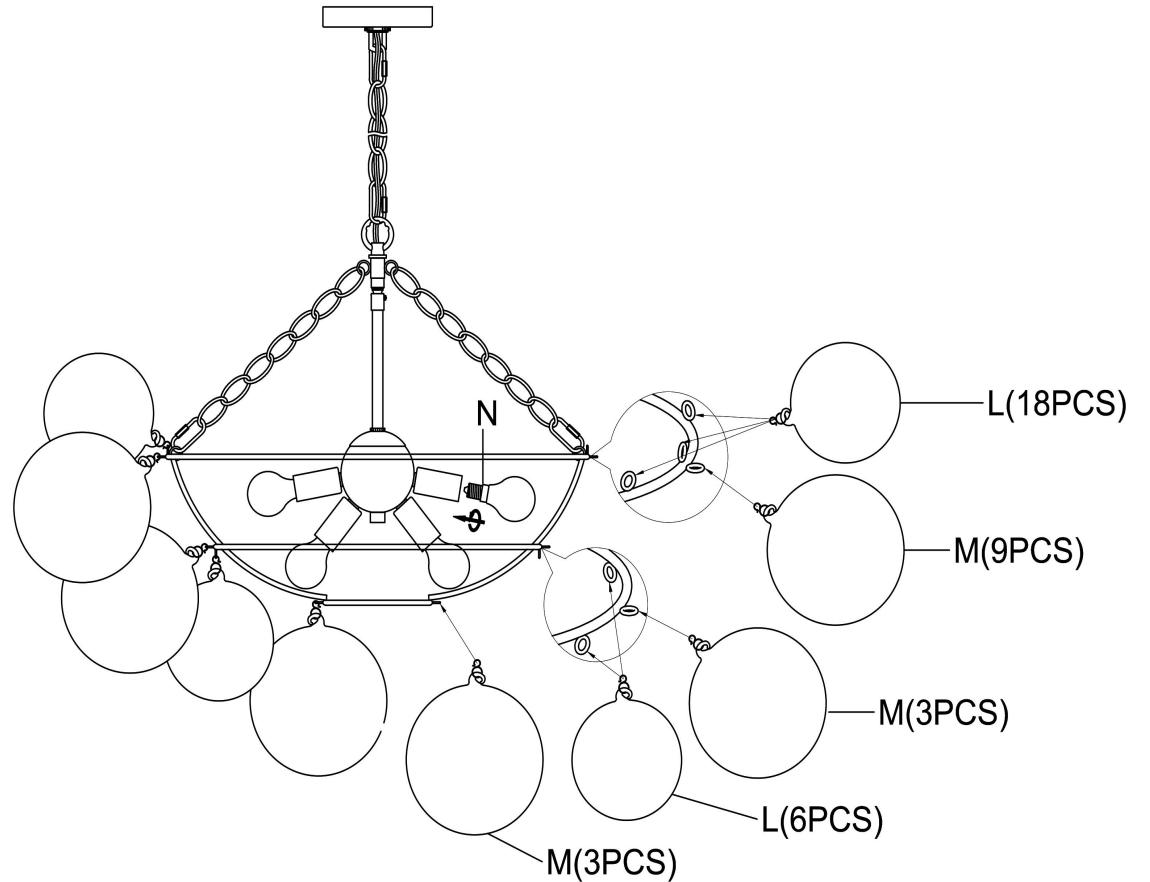

Step 6: Insert the bulbs (N) into the Sockets, Hang the hook on the glass ball on the Frame (K), the Big Glass (M) on the horizontal small circle, and the Small Glass (L) on the vertical small circle